

Kolpen

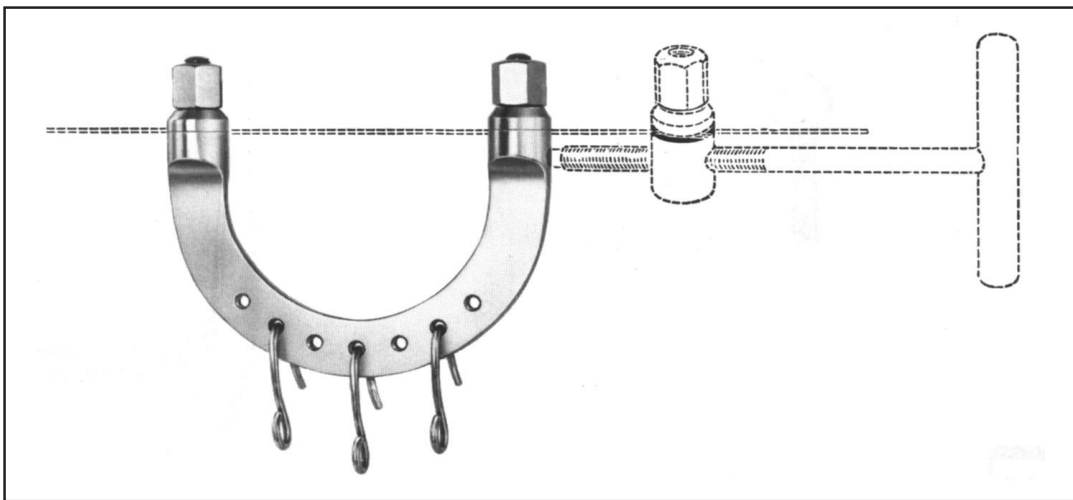

BB

BB



BB.101.92 = 12 mm
BB.101.95 = 15 mm

Spare saw blade



BB.101.35
35,0 cm - 14"

1/4

BB.101.35/95
Charrière
Amputating and
Resection Saws



BB.103.83 = 3 mm
BB.103.85 = 5 mm
BB.103.87 = 7 mm

Spare saw blade



BB.103.39
39,0 cm - 15 1/2"

1/4

BB.103.39/87
Helferich-Bier
Amputating and
Resection Saws



BB.108.20
20,0 cm - 8"

1/3

BB.108.20
Lindemann
Amputating and
Resection Saws



BB.110.23
23,0 cm - 9"

1/3

BB.110.23
Langenbeck
Amputating and
Resection Saws



BB.112.27
27,0 cm -
10 1/2"

BB.112.30
30,0 cm -
12"

1/4

BB.112.27/30
Charrière
Amputating and
Resection Saws

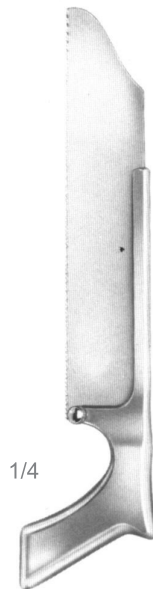

BB.114.31
31,0 cm -
12 1/4"

1/4

BB.114.31
Satterlee
Amputating and
Resection Saws

Bone Drills, Reamers

BOHRINSTRUMENTE, PFRIEME - INSTRUMENTAL PARA PERFORAR,
ESCARIADORES

Kolpen

BONE SURGERY
KNOCHENCHIRURGIE
CIRUGÍA OSEA

BB

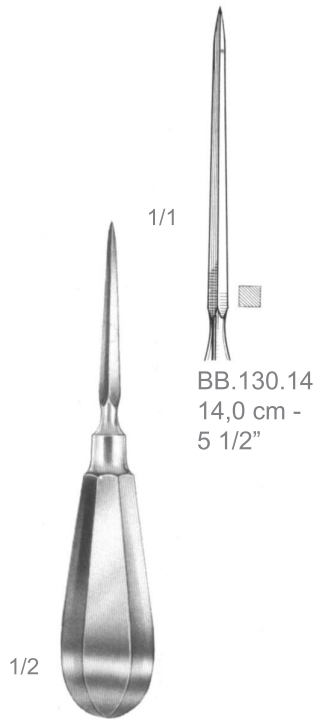

BB.130.14
Bone Drills,
Escariadores

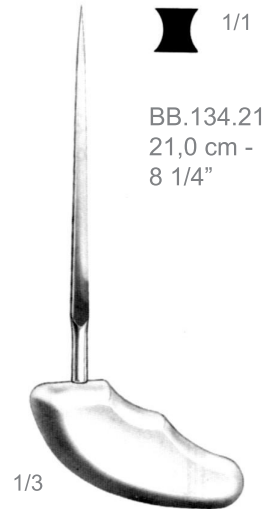

BB.134.21
Perthes
Bone Drills,
Escariadores

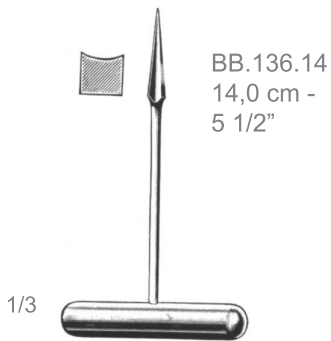

BB.136.14
Bone Drills,
Escariadores

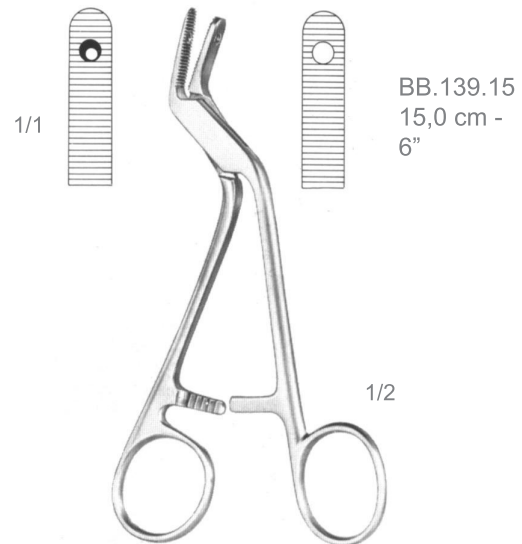

BB.139.15
Adson
Bone Drills,
Escariadores

BB

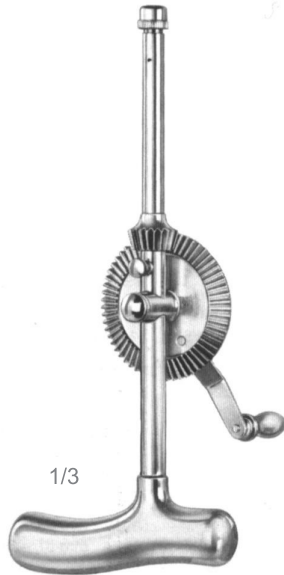

BB.140.00
BB.141.01/03
Stille-Sherman
Hand Drills



BB.141.01 2,5 mm Ø
BB.141.02 3,0 mm Ø
BB.141.03 3,5 mm Ø

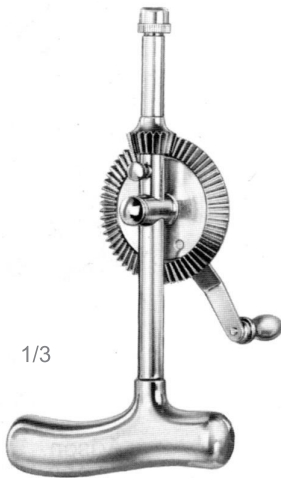

BB.144.00
BB.145.01/12
Stille
Hand Drills



BB.145.01
2,5 mm Ø



BB.145.02
3,0 mm Ø



BB.145.03
3,0 mm Ø



BB.145.04
4,0 mm Ø



BB.145.05
10,0 mm Ø



BB.145.06
5,0 mm Ø



BB.145.07
8,0 mm Ø



BB.145.08
12,0 mm Ø

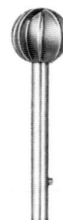

BB.145.09
16,0 mm Ø



BB.145.10
1,0 mm Ø



BB.145.11
1,5 mm Ø



BB.145.12
2,0 mm Ø

BB.152.09



BB.152.00
Hand Drill, with 4 burns fig. 1-4
and extension piece fig. 9

BB.152.00/09
Hudson
Hand Drills



BB.152.01
9,0 mm Ø



BB.152.02
14,0 mm Ø



BB.152.03
16,0 mm Ø



BB.152.04
22,0 mm Ø



Cushing
BB.152.05
14,0 mm Ø



BB.152.06
2,0 mm Ø



McKenzie
BB.152.07
13,0 mm Ø



Errico
BB.152.08
16,0 mm Ø

BB

BB.156.00
Hand Drill, with 3
twist drills



1/3

BB.156.00/08
Moore
Hand Drills



1/2

9.0 cm
Ø 3,2 mm

7.0 cm
Ø 3,2 mm

BB.156.08 Set
Set of Twist Drills, consisting of 1 drill
point 9 cm (3 1/2) and 2 pieces 7 cm
(2 3/4") long, all of them with 3,2 mm Ø

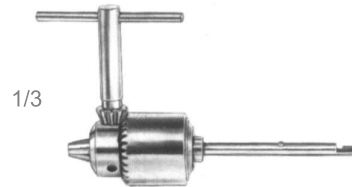

1/3

BB.158.06
Jacobs
Hand Drills

BB.158.06
6,35 mm - 1/4"

Drill Points for Cervical Traction Tongs,
see No. BD.641.04/05

Three-Jaw-Chuck accomodating up to
6,35 mm (1/4") with wrench and
combined Stille-Borchardt-shaft

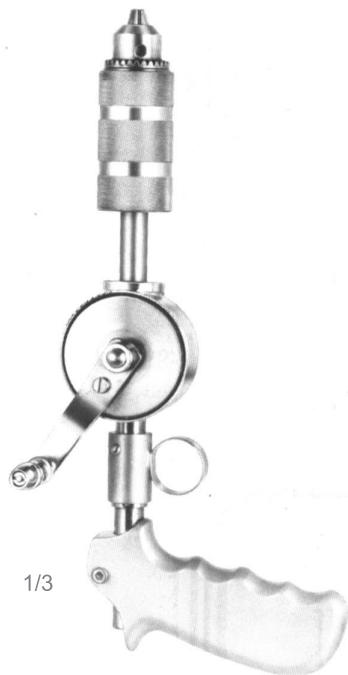

BB.158.00/90
Martin
Hand Drills



BB.158.90
Wrench



BB.158.06
Chuck with Borchardt shaft
Max. opening 6,35 mm

**POR FAVOR VER QUE MODELO
BB.158.06 ES EL CORRECTO**

BB

Handle from artificial wood

2,5 mm



BB.368.25
Screw Drivers

BB.368.25
25,0 cm - 10"

3,5 mm



BB.368.35
Screw Drivers

BB.368.35
25,0 cm - 10"

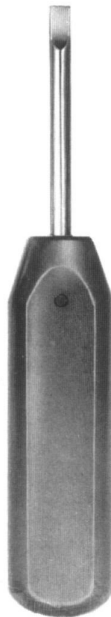

BB.372.17
Screw Drivers

BB.372.17
17,0 cm - 6 3/4"



BB.374.25
Lane
Screw Drivers

BB.374.25
25,0 cm - 10"



BB.378.25
Screw Drivers

BB.378.25
25,0 cm - 10"



BB.380.25
Philips
Screw Drivers

BB.380.25
25,0 cm - 10"

1/2

Screwdriver Set in Case

SCHRAUBENZIEHER-SET MIT ETUI -
 JUEGO DE DESTORNILLADORES EN ESTUCHE

Kolpen

BONE SURGERY
 KNOCHENCHIRURGIE
 CIRUGÍA OSEA

BB



BB.382.00/01
 Screwdriver
 Set in Case



1/2
BB.382.02
 Screwdriver
 Set in Case

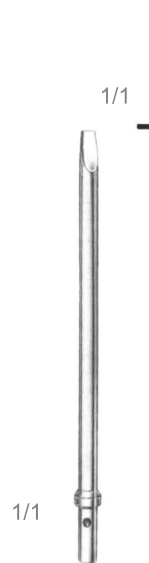

1/1
 1/1 -

BB.382.03
 Screwdriver
 Set in Case

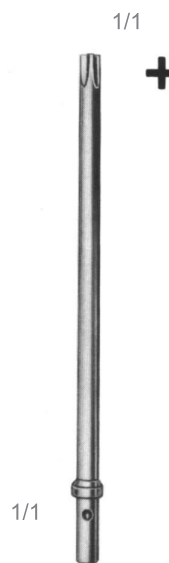

1/1
 1/1 +

BB.382.06
 Screwdriver
 Set in Case

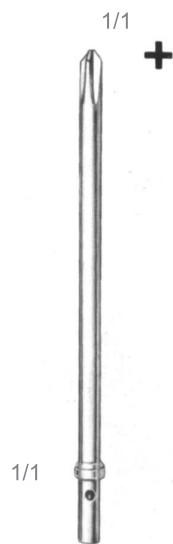

1/1
 1/1 +

BB.382.09
 Screwdriver
 Set in Case



1/1
 1/1 +

BB.382.10
 Screwdriver
 Set in Case



1/1
BB.382.13
 Screwdriver
 Set in Case

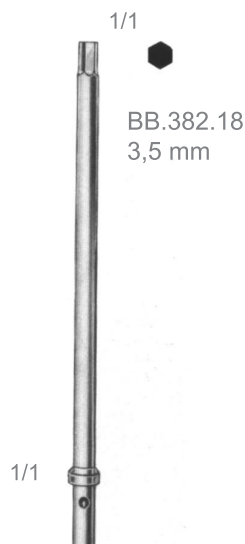

1/1
 BB.382.18
 3,5 mm

BB.382.18
 Screwdriver
 Set in Case

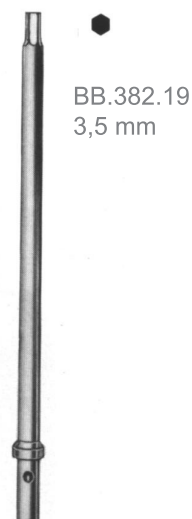

1/1
 BB.382.19
 3,5 mm

BB.382.19
 Screwdriver
 Set in Case

- BB.382.00 Screwdriver Set, complete, in case
- BB.382.01 Sterilizing Case, only
- BB.382.02 Screwdriver, perforated, with rapid chuck, only
- BB.382.03 Attachment, slot, only
- BB.382.06 ditto, Cruciform, only
- BB.382.09 ditto, Phillips large size, only
- BB.382.10 ditto, Phillips small size, only
- BB.382.13 Jacobs Universal three-jaw chuck, 6,3 mm, only
- BB.382.18 Wrench for inner hexagonals, 3,5 mm, only
- BB.382.19 ditto, 2,5 mm

BB

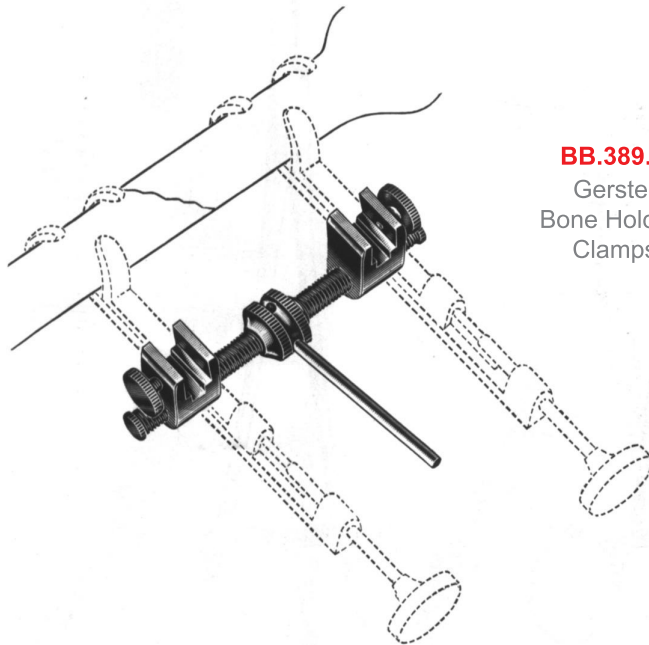

BB.389.15
Gerster
Bone Holding
Clamps

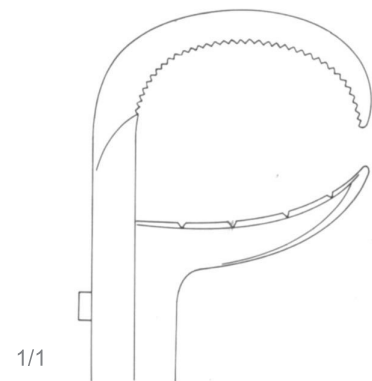

1/1

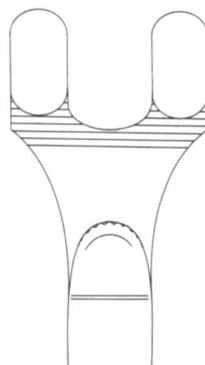

- BB.387.18 18,0 cm - 7"
- BB.387.20 20,0 cm - 8"
- BB.387.22 22,0 cm - 8 3/4"



BB.387.18/22
Gerster-Lowmann
Bone Holding Clamps

Wire Twisting Forceps

DRAHT-ZANGEN - PINZAS PARA TORCER HILOS

Kolpen

BONE SURGERY
KNOCHENCHIRURGIE
CIRUGÍA OSEA

BB

Kolpen *GOLD*

Wire Twisting Forceps

for wire twisting
*safe grip
*slide-proof



BB.500.01
15,0 cm - 6"

BB.500.02
18,0 cm - 7"

BB.500.01/02
Wire Twisting
Forceps



BB.500.11
15,0 cm - 6"

BB.500.12
18,0 cm - 7"

BB.500.11/12
Wire Twisting
Forceps



BB.500.15
15,0 cm -

BB.500.15
Wire Twisting
Forceps



BB.500.20
20,0 cm - 8"

BB.500.20
Wire Twisting
Forceps



BB.506.18
18,5 cm - 7 1/4"

BB.506.18
Wire Twisting
Forceps

BB

Kolpen *GOLD*



BB.502.01
Corwin
Wire Twisting
Forceps

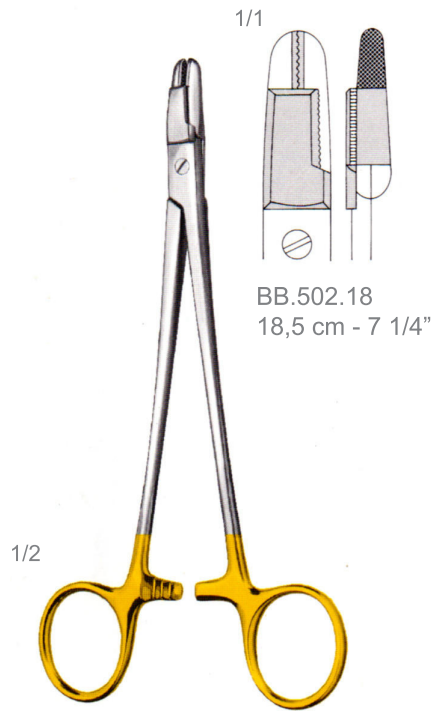

BB.502.18
Martin
Wire Twisting
Forceps

Flat Nose Pliers, Wire Cutting Pliers, Seizing Forceps

FLACHZANGEN, DRAHT-KNEIFZANGEN, FABZANGEN
 ALICATES PLANOS, ALICATES PARA CORTAR ALAMBRE, PINZAS
 PARA COGER

Kolpen

BONE SURGERY
 KNOCHENCHIRURGIE
 CIRUGÍA OSEA

BB



BB.502.17
 16,5 cm - 6 1/2"

BB.502.17
 Flat Nose Pliers

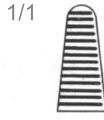
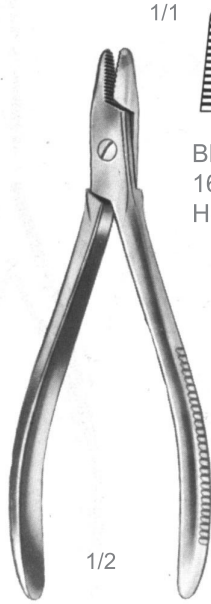

BB.504.16
 16,0 cm - 6 1/4"
 Heavy pattern

BB.504.16
 Flat Nose Pliers

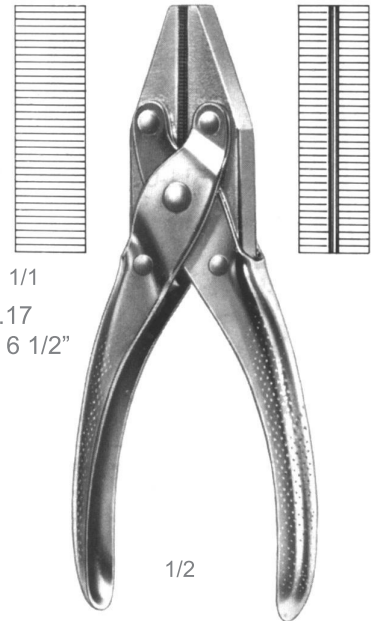

BB.505.17
 17 cm - 6 1/2"

BB.505.17
 Flat Nose Pliers

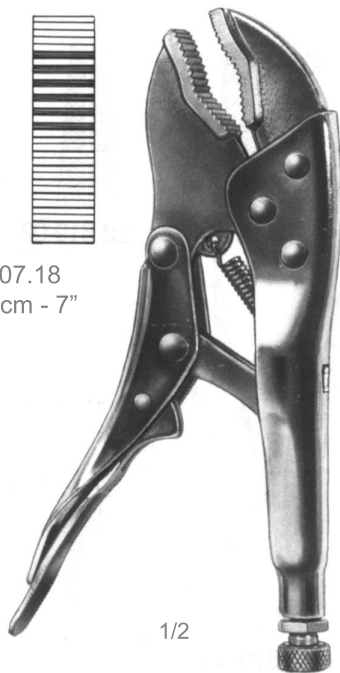

BB.507.18
 18,0 cm - 7"

BB.507.18
 Flat Nose Pliers

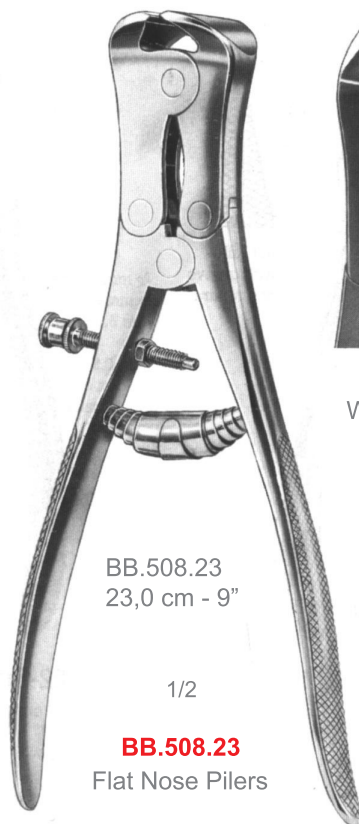

BB.508.23
 23,0 cm - 9"

BB.508.23
 Flat Nose Pliers

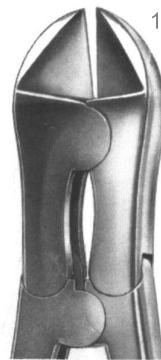

BB.508.25
 25,0 cm - 9 3/4"

BB.508.25
 Wire Twisting
 Forceps

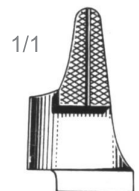

BB.510.15
 15,0 cm - 6"

BB.510.15
 Flat Nose Pliers

BB



1/2

BB.511.01/03
Flat Nose Pilers

Kolpen *GOLD*

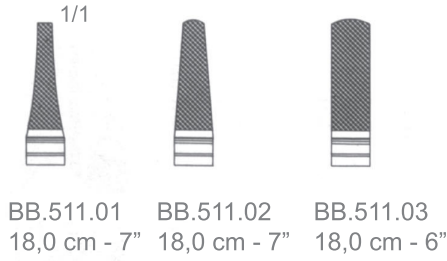

1/2

BB.512.18
BB.514.18
Flat Nose Pilers

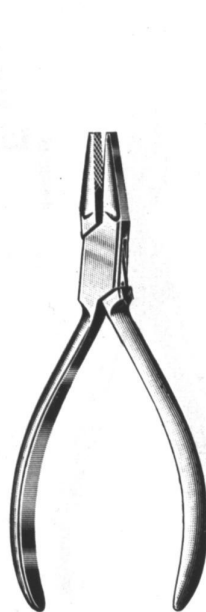
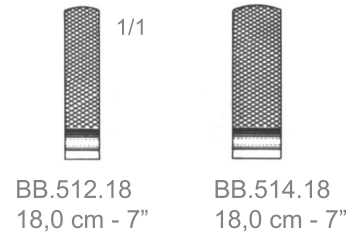

1/2

BB.516.14
Flat Nose Pilers

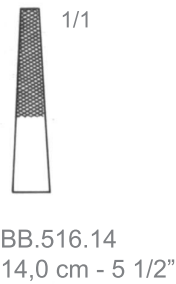

1/2

BB.518.16
Flat Nose Pilers



Flat Nose Pliers

FLACHZANGEN - ALICATES PLANAS

Kolpen

BONE SURGERY
KNOCHENCHIRURGIE
CIRUGÍA OSEA

BB

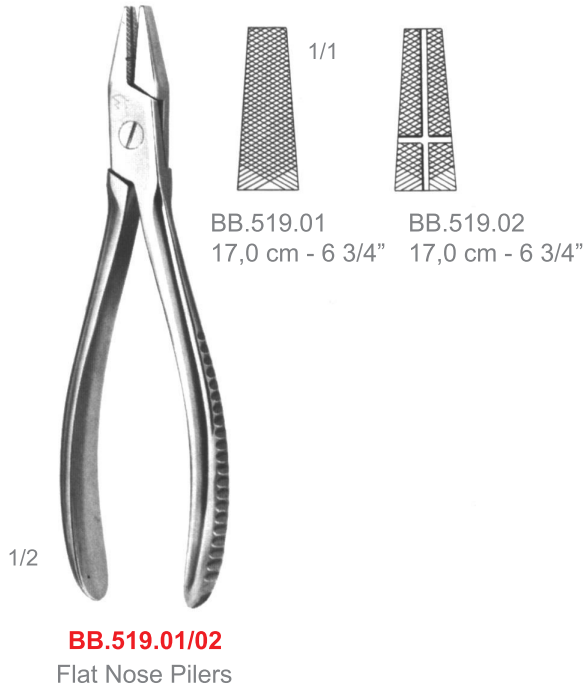

BB

Kolpen *GOLD*



BB.520.16
16,0 cm - 6 1/4"

1/2

BB.520.16
Wire Cutting Pliers



BB.522.16
16,0 cm - 6 1/4"

1/2

BB.522.16
Martin-Diamant
Wire Cutting Pliers



BB.523.01
17,5 cm - 7"
for hard wires
up to 2,2 mm Ø
Spare parts, set
complete with 2 spare
inserts, screws and
hexagonal key

1/2

BB.523.01
Martin "Gigant-Compact"
Wire Cutting Pliers

Kolpen *GOLD*

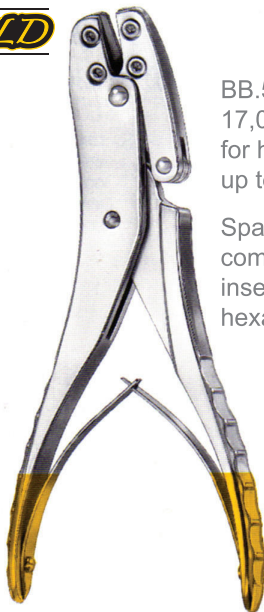

BB.523.02
17,0 cm - 9"
for hard wires
up to 3,0 mm Ø
Spare parts, set
complete with 2 spare
inserts, screws and
hexagonal key

1/2

BB.523.02
Martin "Gigant-Compact"
Wire Cutting Pliers



BB.523.16
16,0 cm - 5 1/2"
-for hard wires
up to 1,6 mm Ø
-for soft wires
up to 2,0 mm Ø

1/1

1/2

BB.523.16
Wire Cutting Pliers

Wire Cutting Pliers

DRAHT-KNEIFZANGEN - ALICATES PARA CORTAR ALAMBRE

Kolpen

BONE SURGERY
KNOCHENCHIRURGIE
CIRUGÍA OSEA

BB



BB.523.22
22,0 cm - 8 3/4"
-for wires
up to 2,5 mm Ø

BB.523.22
Wire Cutting Pliers



BB.524.15
15,0 cm - 6"

BB.524.15
Wire Cutting Pliers

Kolpen **GOLD**

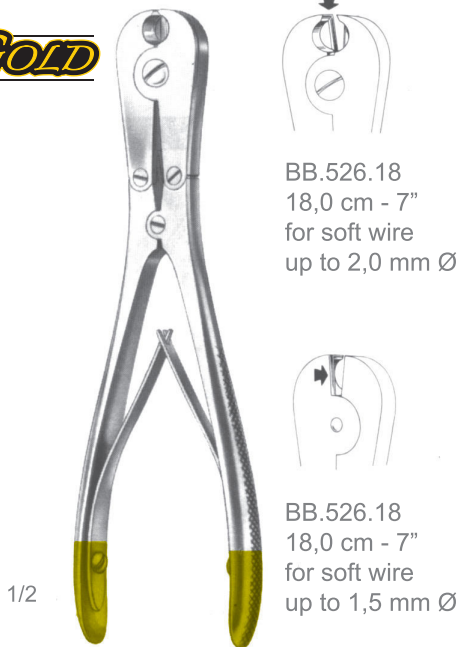

BB.526.18
18,0 cm - 7"
for soft wire
up to 2,0 mm Ø

BB.526.18
18,0 cm - 7"
for soft wire
up to 1,5 mm Ø

BB.526.18
Wire Cutting Pliers

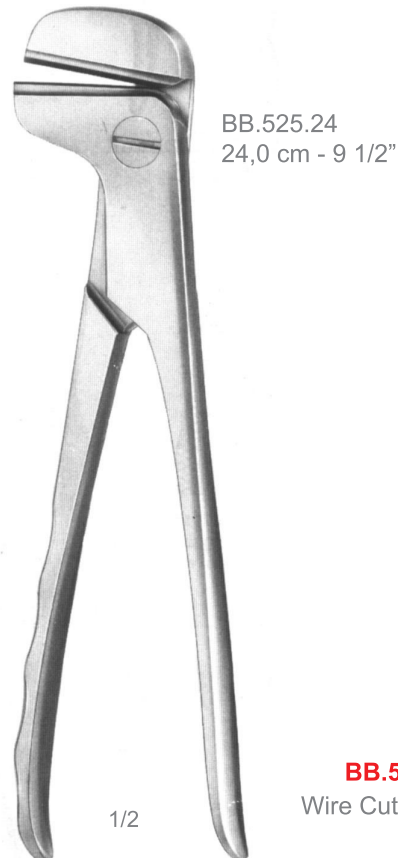

BB.525.24
24,0 cm - 9 1/2"

BB.525.24
Wire Cutting Pliers

BB



BB.527.02/15
BB.529.03/10
Bone wire,
bone wire guides

mm Ø	soft	hard
0.2	BB.527.02	
0.3	BB.527.03	BB.529.03
0.4	BB.527.04	BB.529.04
0.5	BB.527.05	
<hr/>		
0.6	BB.527.06	BB.529.06
0.7	BB.527.07	
0.8	BB.527.08	BB.529.08
0.9	BB.527.09	
<hr/>		
1.0	BB.527.10	BB529.10
1.2	BB.527.12	
1.5	BB.527.15	

BB.527.02/15
Bone Wire, in coils of 10 m (33 ft.)
Soft, from 0.2-1.5 mm Ø

BB.529.03/10
Bone Wire, in coils of 10 m (33 ft.)
Hard, from 0.3-1.0 mm Ø



1/3

BB.535.01/03
Demel
Bone wire,
bone wire guides

BB.535.01
BB.535.02
BB.535.03

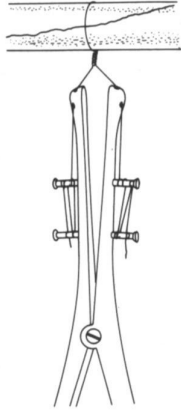

BB.538.28
28,0 cm - 11"

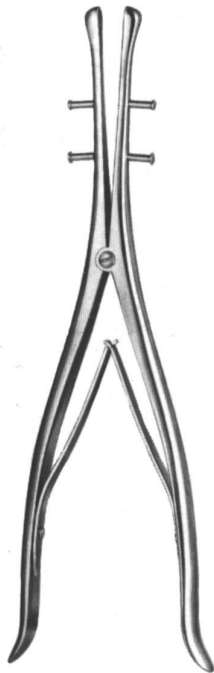

1/3

BB.538.28
Demel
Bone wire Tighteners

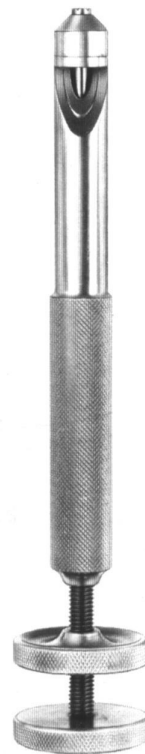

BB.542.21
21,0 cm - 8 1/4"

1/2

BB.542.21
Loute
Bone wire Tighteners

BB



BB.550.06	60 mm	4,0 mm Ø
BB.550.08	80 mm	4,0 mm Ø
BB.550.10	100 mm	4,0 mm Ø

with flat tip

BB.550.06/10
Schanz
Steinmann Pinz,
Schanz Screws



BB.552.10	100 mm	5,0 mm Ø
BB.552.12	125 mm	5,0 mm Ø
BB.552.15	150 mm	5,0 mm Ø
BB.552.17	175 mm	5,0 mm Ø
BB.552.20	200 mm	5,0 mm Ø
BB.552.25	250 mm	5,0 mm Ø

with Trocar tip

BB.552.10/25
Schanz
Steinmann Pinz,
Schanz Screws



BB.554.10	100 mm	6,0 mm Ø
BB.554.13	130 mm	6,0 mm Ø
BB.554.16	160 mm	6,0 mm Ø
BB.554.19	190 mm	6,0 mm Ø

with flat tip

BB.554.10/19
Schanz
Steinmann Pinz,
Schanz Screws



BB.562.14	140 mm	4,0 mm Ø
BB.562.16	160 mm	4,0 mm Ø
BB.562.18	180 mm	4,0 mm Ø
BB.562.20	200 mm	4,0 mm Ø

with Trocar tip

BB.562.14/20
Steinmann
Steinmann Pinz,
Schanz Screws



1/2

BB.568.01
Palmer
Palmer Bound Nails

BB.568.01
15,0 cm - 6"
Introducer
Material used for implants:
Stainless steel acc. to DIN 17443
resp. ISO 5832/1 composition B
(AISI 316 LVM)



1/2

BB.568.02
Palmer
Palmer Bound Nails

BB.568.02
17,5 cm - 7"
Impactor
Material used for implants:
Stainless steel acc. to DIN 17443
resp. ISO 5832/1 composition B
(AISI 316 LVM)



BB.568.15/70
Palmer
Palmer Bound Nails

BB.568.15	15 mm
BB.568.20	20 mm
BB.568.25	25 mm
BB.568.30	30 mm
BB.568.35	35 mm
BB.568.40	40 mm
BB.568.45	45 mm
BB.568.50	50 mm
BB.568.55	55 mm
BB.568.60	60 mm
BB.568.65	65 mm
BB.568.70	70 mm

BB

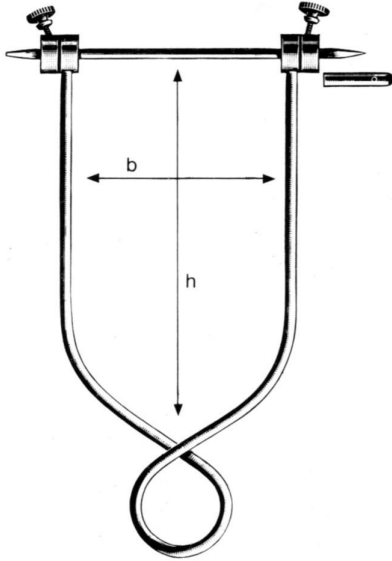

BB.565.15	21x15 cm	8"x6"	for femur and knee
BB.565.16	16x9 cm	6 1/4"x3 1/2"	for arm
BB.565.21	21x11 cm	8 1/4"x4 1/2"	for thigh and knee

BB.565.15/21

Böhler
Extension Bows,
Fracture Pins

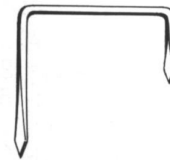

BB.569.16/22
Clips

BB.569.16/22

Wilberg
Extension Bows,
Fracture Pins



BB.575.01	Large Model
BB.575.02	Small Model
BB.575.99	Extension Bow

BB.575.01/99

Modif. Schramberg
Extension Bows,
Fracture Pins

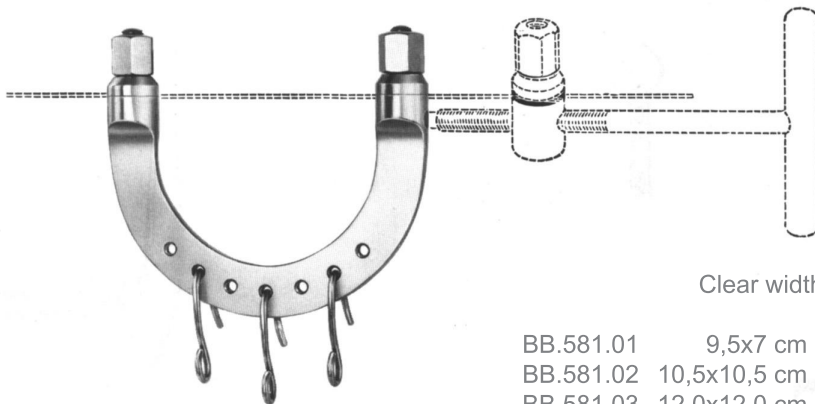

Clear width

BB.581.01	9,5x7 cm	3 3/4"x2 3/4"
BB.581.02	10,5x10,5 cm	4 1/4"x4 1/4"
BB.581.03	12,0x12,0 cm	4 3/4"x4 3/4"
BB.581.04	15,5x15,5 cm	6"x6"
BB.581.05	20,0x15,5 cm	8"x6"

BB.581.01/05

Kirschner
Extension Bows

with 3 traction hooks

BB.585.01	18,5 cm - 7 1/4"	0-40 mm
BB.585.02	27,0 cm - 10 1/2"	35-200 mm

with 3 traction hooks

BB.583.01 6x6 cm 2 1/2"x2"
with 3 traction hooks



BB.583.01

Kirschner
Extension Bows

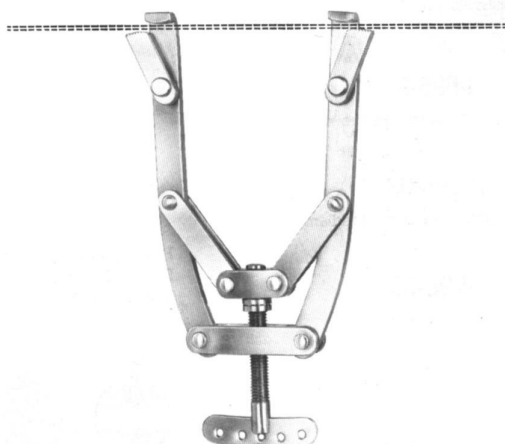

BB.585.01/02

Kirschner
Extension Bows

BB



1/4

BB.586.18
Wire Strainer for Kirschner
Extension Bows BB.581.01/05

BB.586.18
Extension Bows



1/4

BB.587.19
Screw Nut Wrench for
BB.581.01/05 and
BB.604.18

BB.587.19
Extension Bows

Clear Width

BB.589.18 18x10 cm 7"x4"
BB.589.27 27x27 cm 10 1/2"x6 1/4"

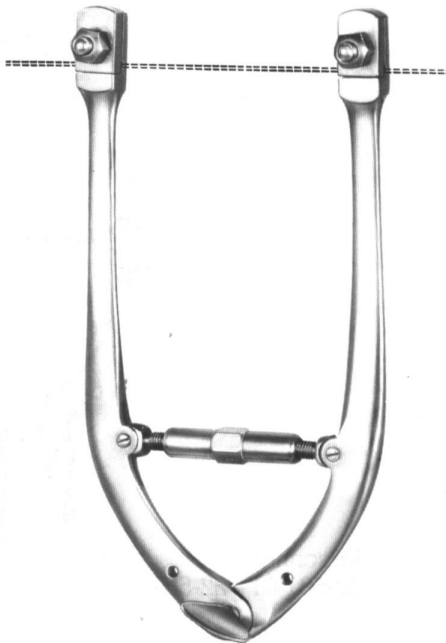

BB.589.18/27
Extension Bows



BB.596.01 Small
BB.596.02 Medium
BB.596.03 Large

Wire gauze, sterilizable

BB.596.01/03
Extension Bows



1/1

BB.601.02
pair
Fixation Disks for
wire drills

BB.601.02
Extension Bows



BB.603.03/06
Extension Bows

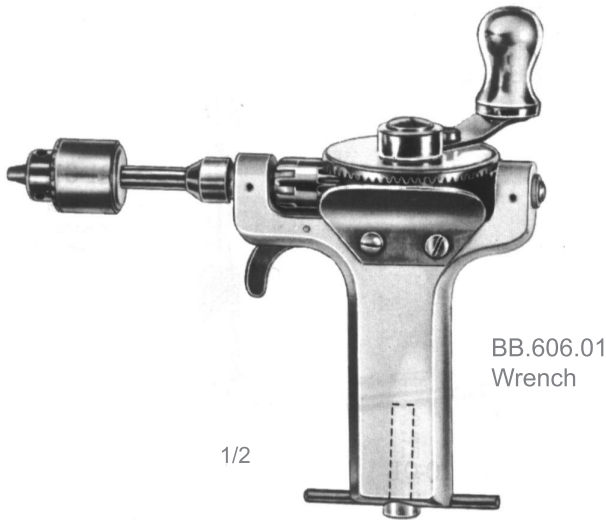

BB.606.00/01
Bunnell
Hand Drills



BB.611.01
Ralk
Hand Drills

- BB.606.00 Hand Drill, 16 cm, longitudinally bored, with three-jaw-chuck and key, opening up to 4 mm Ø
- BB.606.01 Spare Key for three-jaw-chuck
- BB.611.01 Hand Drill with light metal case and laterally angled handle, with three-jaw-chuck and key, opening up to 6,35 mm Ø

BB

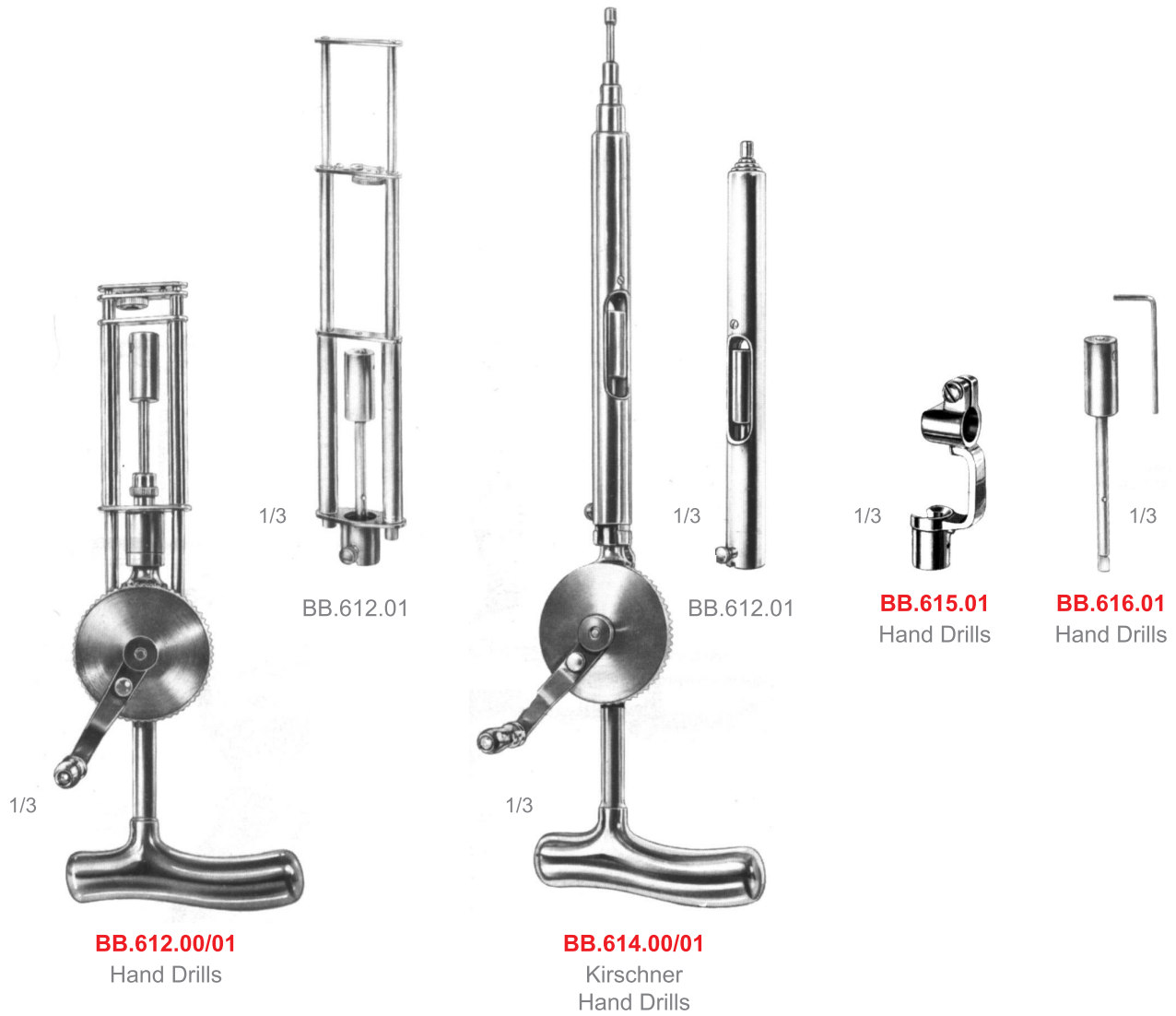

- BB.612.00 Hand Drill with telescopic wire drill guide
BB.612.01, coupling bow BB.615.01 and chuck with key
- BB.612.01 Telescopic Wire Drill Guide, with chuck and fitting BB.612.00
- BB.614.00 Hand Drill with Telescopic Wire Drill Guide BB.614.01,
coupling bow BB.615.01 and chuck
- BB.614.01 Telescopic Wire Drill Guide, with chuck and key BB.616.01,
fitting BB.614.00
- BB.615.01 Coupling-bow, only for wire drill guides BB.612.01 and BB.614.01



BB.618.00
14,0 cm - 5 1/2"

BB.618.00
Vickers
Hand Drills

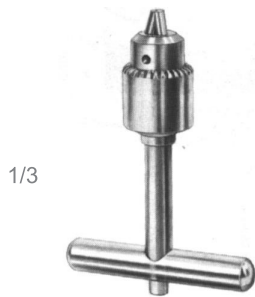

1/3

BB.620.01
Hand Drills

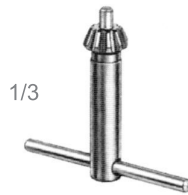

1/3

BB.620.99
Hand Drills

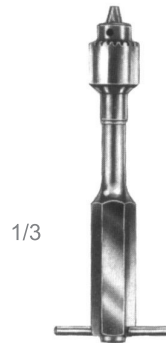

1/3

BB.621.00
Hand Drills

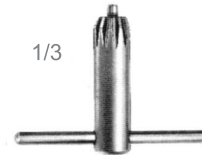

1/3

BB.621.01
Hand Drills

BB.620.01 Handle with chuck and key, accomodating up to 6,35 mm (1/4"), perforated, for inserting and extracting nails, guide pins and wire guide drills

BB.620.99 Key

BB.621.00 Hand drill, perforated, with three-jaw-chuck and key, accomodating up to 3,95 mm (5/32")

BB.621.01 Key

BB



Wire Drill dispenser

□

mm Ø	length 60 mm/2 1/2"	length 120 mm/5"	length 140 mm/5 1/2"	length 160 mm/6 1/4"	length 310/12 1/4"
BB.622.10/22	BB.622.10	BB.626.10	BB.628.10	BB.630.10	BB.632.10
BB.626.10/22	BB.622.12	BB.626.12	BB.628.12	BB.630.12	BB.632.12
BB.628.10/22	BB.622.14	BB.626.14	BB.628.14	BB.630.14	BB.632.14
BB.630.10/25	BB.622.15	BB.626.15	BB.628.15	BB.630.15	BB.632.15
BB.632.10/25					
Kirschner Wire Drills	1,6 BB.622.16	BB.626.16	BB.628.16	BB.630.16	BB.632.16
	1,8 BB.622.18	BB.626.18	BB.628.18	BB.630.18	BB.632.18
	2,0 BB.622.20	BB.626.20	BB.628.20	BB.630.20	BB.632.20
Trocar point square chuck end	2,2 BB.622.22	BB.626.22	BB.628.22	BB.630.22	BB.632.22
	2,5			BB.630.25	BB.632.25

○

mm Ø	length 60 mm/2 1/2"	length 120 mm/5"	length 140 mm/5 1/2"	length 160 mm/6 1/4"	length 310/12 1/4"
BB.623.10/22	BB.623.10	BB.627.10	BB.629.10	BB.631.10	BB.633.10
BB.627.10/22	BB.623.12	BB.627.12	BB.629.12	BB.631.12	BB.633.12
BB.629.10/22	BB.623.14	BB.627.14	BB.629.14	BB.631.14	BB.633.14
BB.631.10/25	BB.623.15	BB.627.15	BB.629.15	BB.631.15	BB.633.15
BB.633.10/25					
Kirschner Wire Drills	1,6 BB.623.16	BB.627.16	BB.629.16	BB.631.16	BB.633.16
	1,8 BB.623.18	BB.627.18	BB.629.18	BB.631.18	BB.633.18
	2,0 BB.623.20	BB.627.20	BB.629.20	BB.631.20	BB.633.20
Trocar point round chuck end	2,2 BB.623.22	BB.627.22	BB.629.22	BB.631.22	BB.633.22
	2,5			BB.631.25	BB.633.25



Wire Drill dispenser



mm Ø length
310/12 1/4"

BB.634.10/25

Kirschner
Wire Drills

Diamond point
square chuck end

1,0	BB.634.10
1,2	BB.634.12
1,5	BB.634.15
1,6	BB.634.16

1,8	BB.634.18
2,0	BB.634.20
2,2	BB.634.22
2,5	BB.634.25