

# Kolpen

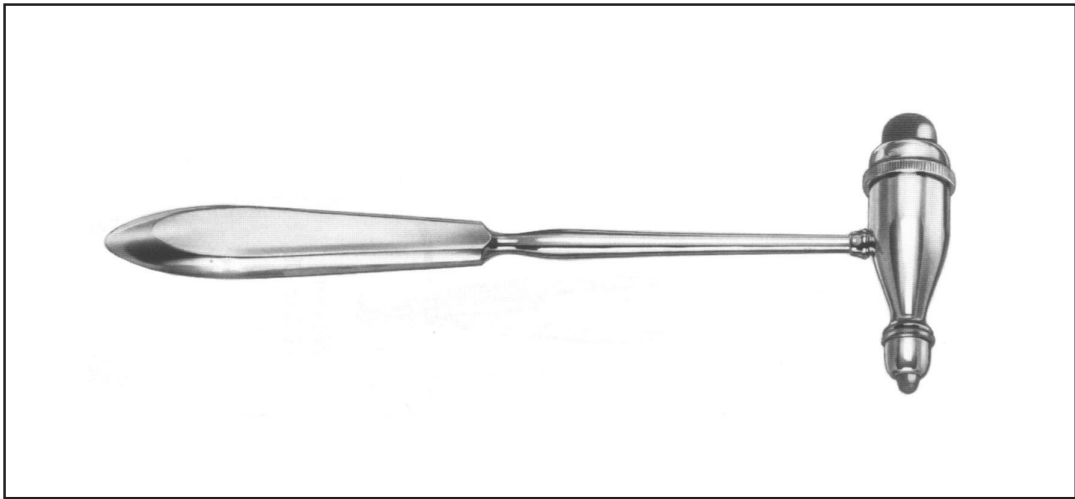

---

**AG**



AG

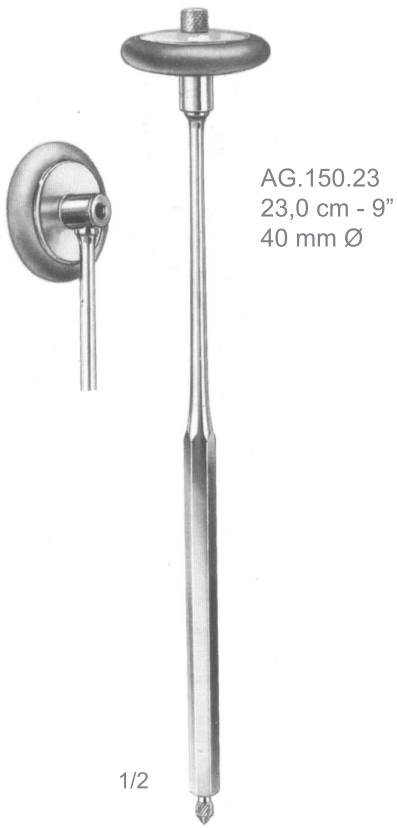

**AG.150.23**  
Rabiner  
Percussion Hammers



**AG.155.18**  
Buck  
Percussion Hammers

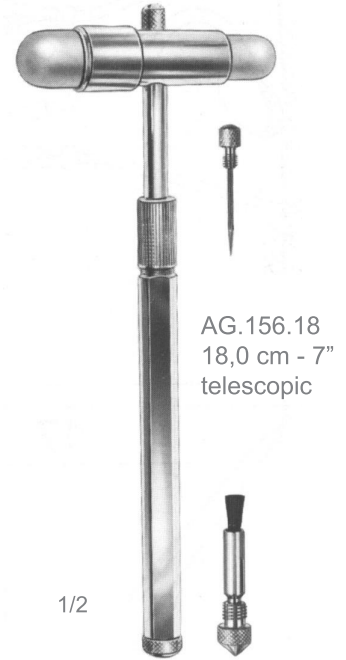

**AG.156.18**  
Buck  
Percussion Hammers

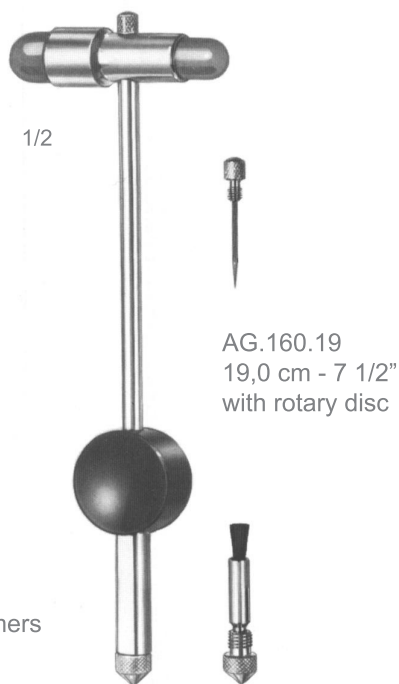

**AG.160.19**  
Martin-Mobile  
Percussion Hammers

Percussion Hammers

PERKUSSIONSHÄMMER - MARTILOS DE PERCUSIÓN

# Kolpen

DIAGNOSTICS  
DIAGNOSTIK-BESTECKE  
JUEGOS PARA DIAGNÓSTICO

**AG**

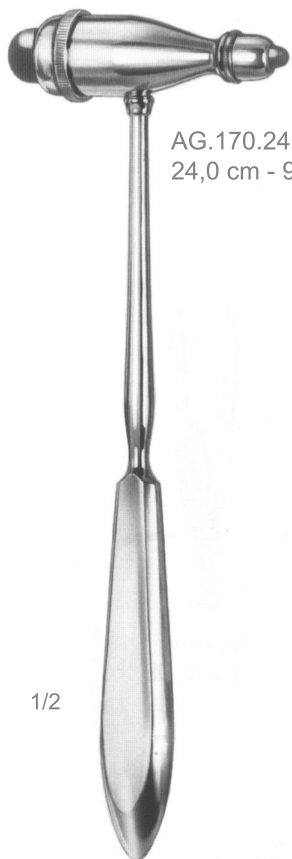

AG.170.24  
24,0 cm - 9 1/2"

1/2

**AG.170.24**  
Troemmer  
Percussion Hammers



AG.181.22  
22,0 cm - 8 3/4"

1/2

**AG.181.22**  
Neuro-Duoflex  
Mod. Déjerine  
Percussion Hammers

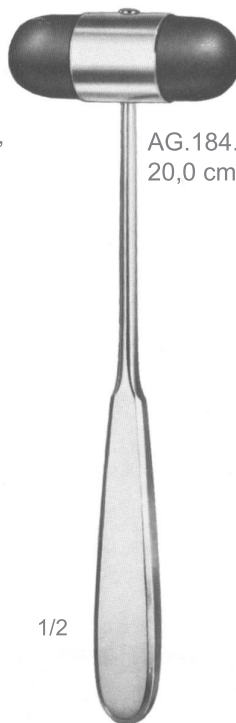

AG.184.20  
20,0 cm - 8"

1/2

**AG.184.20**  
Déjerine  
Percussion Hammers



AG.185.21  
21,0 cm - 8 1/4"

1/2

**AG.185.21**  
Déjerine  
Percussion Hammers



AG.190.20  
20,0 cm - 8"

1/2

**AG.190.20**  
Taylor  
Mod. USA  
Percussion Hammers

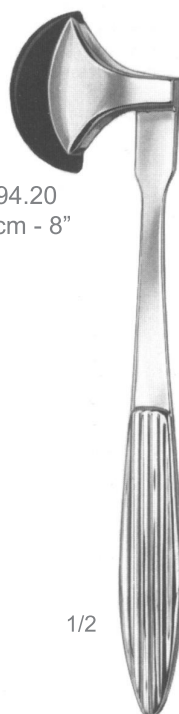

AG.194.20  
20,0 cm - 8"

1/2

**AG.194.20**  
Berliner  
Percussion Hammers

AG

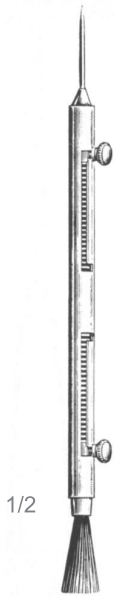

AG.205.17  
17,0 cm - 6 1/2"

1/2

**AG.205.17**  
Aly  
Sensibility Instruments  
Stethoscopes

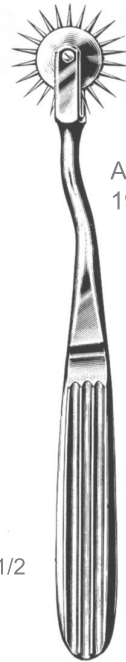

AG.210.19  
19,0 cm - 7 1/2"

1/2

**AG.210.19**  
Wartenberg  
Sensibility Instruments  
Stethoscopes



AG.215.09  
9,0 cm - 3 1/2"

1/2

**AG.215.09**  
Weber  
Sensibility Instruments  
Stethoscopes



AG.242.18  
18,0 cm - 7"  
of wood

1/2

**AG.242.18**  
Pinard  
Sensibility Instruments  
Stethoscopes



AG.248.15  
15,0 cm - 6"  
of aluminium

1/2

**AG.248.15**  
Pinard  
Sensibility Instruments  
Stethoscopes

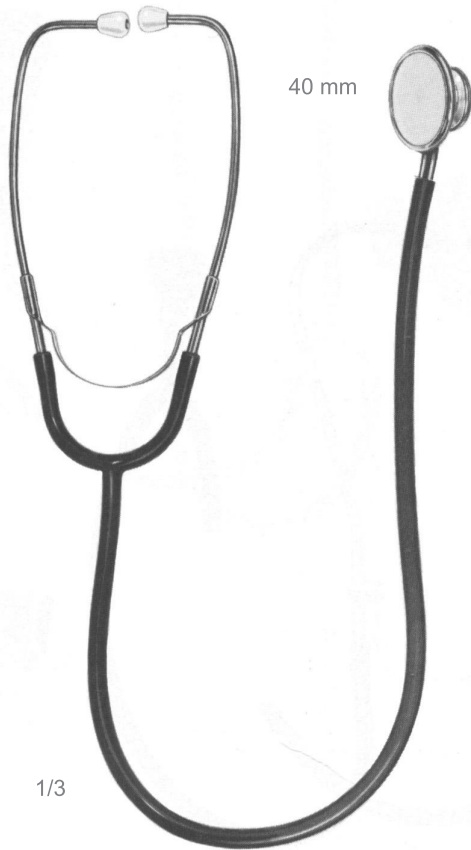

40 mm

AG.260.00  
Aluminium, anodized  
extra lightweight

1/3

**AG.260.00**  
Duplex  
Stethoscopes



37 mm

AG.262.00  
Aluminium, anodized  
extra lightweight

1/3

**AG.262.00**  
Baby-Duplex  
Stethoscopes

AG



AG.281.01  
Ford Stethoscope  
with complete folding  
type binaural

1/3

**AG.281.01**  
Ford  
Stethoscopes

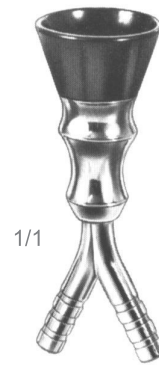

1/1

**AG.285.01**  
Ford  
Stethoscopes

AG.285.01  
Chestpiece only



1/1

**AG.285.09**  
Ford  
Stethoscopes

AG.285.09  
Hard Rubber  
Bell only



47 mm

1/3

1/2

**AG.265.00**  
Anestophon  
Stethoscopes

AG.265.00  
Aluminium, anodized  
extra lightweight

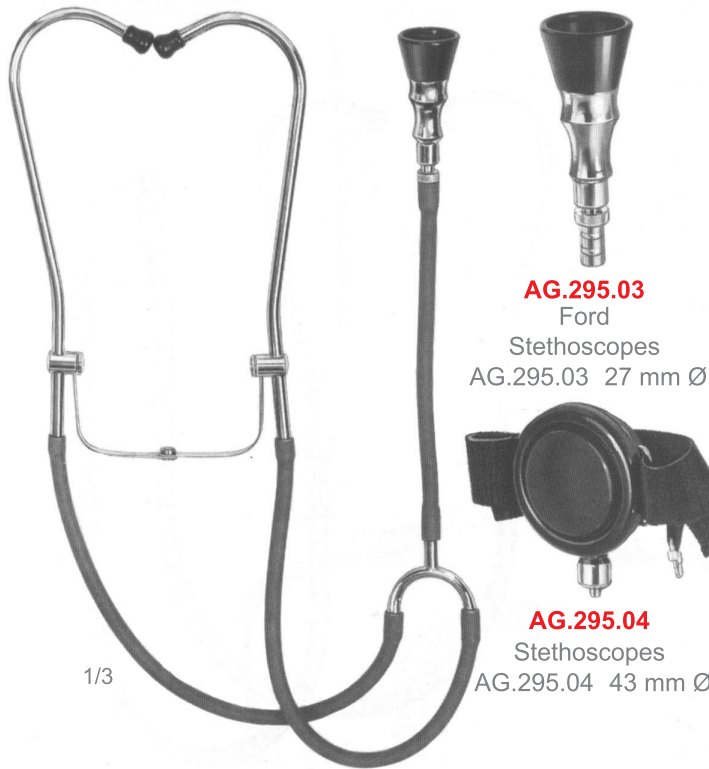

**AG.291.02**  
Martin-Trofon  
Stethoscopes

**AG.321.02**  
Bowles  
Stethoscopes

AG.291.02 Martin-Trioфон 1, consisting of  
1 Bowles chestpiece 40 mm Ø  
1 Ford chestpiece 27 mm Ø  
1 Chestpiece with bracelet  
1 folding type binaural, Y-piece,  
communication tubings with Luer-Lok fitting

AG.321.02 Bowles Stethoscope consisting of  
Bowles chestpiece 40 mm Ø,  
folding type binaural, Y-piece,  
connecting tubes.  
AG.325.02 Bowles Chestpiece 40 mm Ø only

AG.291.02 Complete in plastic pouch  
AG.295.01 Bowles Chestpiece 40 mm Ø only  
AG.295.03 Ford Chestpiece 27 mm Ø only  
AG.295.04 Chestpiece with bracelet only



**AG.345.02**  
Rieger-Sprague  
Stethoscopes



**AG.341.01**  
Rieger-Sprague  
Stethoscopes

AG.341.01 Rieger-Sprague Double Stethoscope, consisting of Rieger-Sprague Double chestpiece, connecting tubes and folding type binaural, in cardboard box

AG.345.02 Rieger-Sprague Double chestpiece, only changeable

**AG.365.01**  
Harter (Stereo)  
Stethoscopes

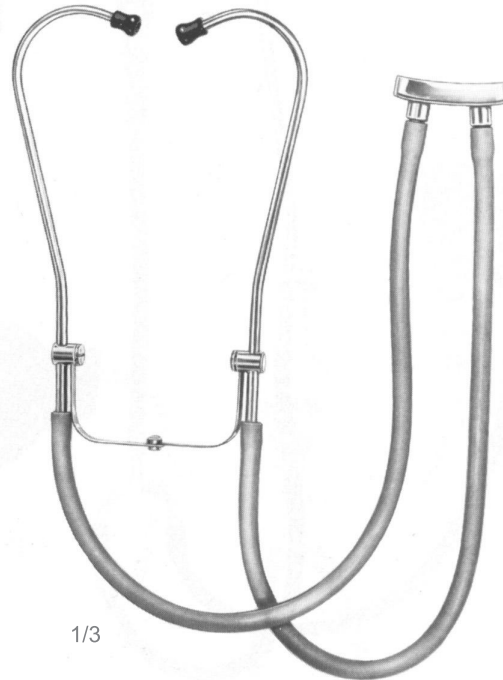
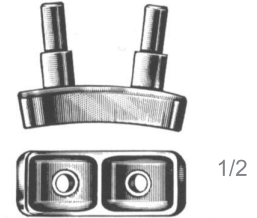

**AG.361.01**  
Harter (Stereo)  
Stethoscopes

AG.361.01 Harter Stereo Stethoscope, consisting of Harter Stereo chestpiece, connecting tubes and folding binaural, in cardboard box

AG.365.01 Harter Stereo chestpiece only

## Stethoscopes, Accessories for Stethoscopes

STETHOSKOPE, ZUBEHÖRTEILE FÜR STETHOSKOPE -  
ESTETOSCOPIOS, ACCESORIOS PARA ESTETOSCOPIOS

# Kolpen

DIAGNOSTICS  
DIAGNOSTIK-BESTECKE  
JUEGOS PARA DIAGNÓSTICO

**AG**

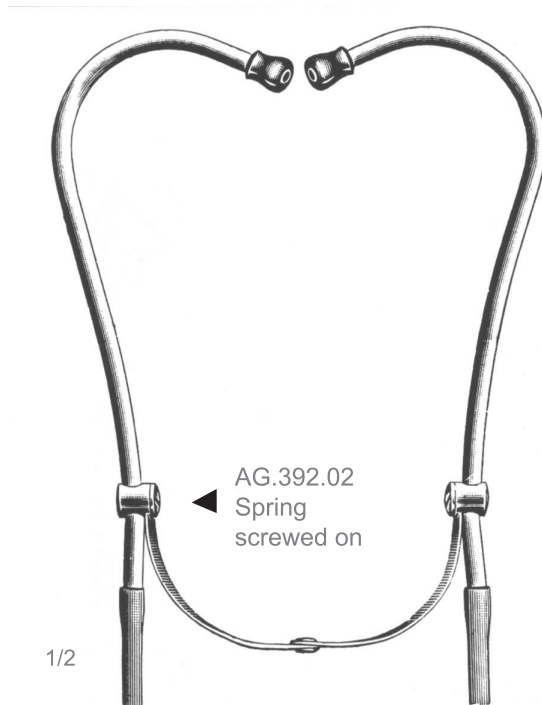

AG.392.02  
Spring  
screwed on

1/2

**AG.392.02**

Stethoscopes  
Accessories for  
Stethoscopes



1/2

**AG.395.01**

Stethoscopes  
Accessories for  
Stethoscopes



**AG.392.03**  
Mod. Schweiz  
(Binaural, short type)  
Stethoscopes, Accessories for  
Stethoscopes

1/2



1/2

**AG.395.04**

Stethoscopes  
Accessories for  
Stethoscopes



AG.396.06  
6 mm Ø

1/2

**AG.396.06**

Stethoscopes  
Accessories for  
Stethoscopes

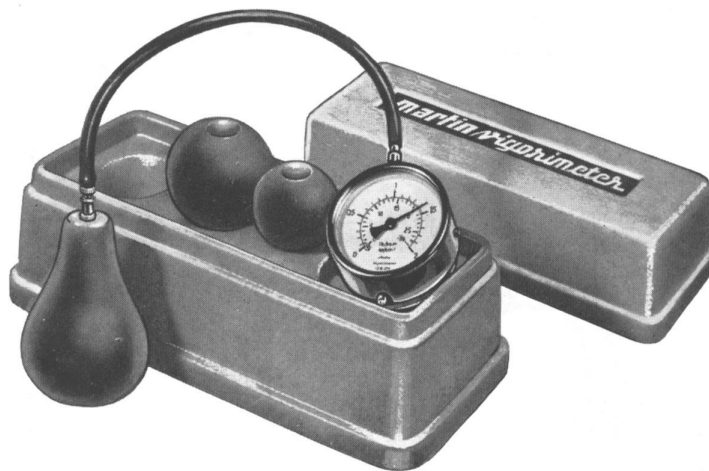

AG.400.01 26 x 12 x 12.5 cm  
10 x 4 3/4 x 5"

**AG.400.01/05**

Martin-Vigorimeter®  
Examination and  
Measuring Instruments

AG.400.01 Martin-Vigorimeter Dynamometer,  
consisting of  
3 rubber bulbs (small, medium, and large),  
with cone adaptors, tubing with metal mount,  
and manometer, complete in plastic case.

AG.400.05 Set Rubber Bulbs only

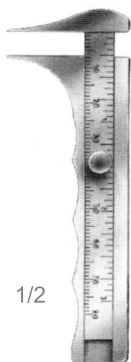

1/2

**AG.407.01**  
Jameson  
Examination and  
measuring Instruments



1/2

**AG.408.01**  
Caroll  
Examination and  
measuring Instruments

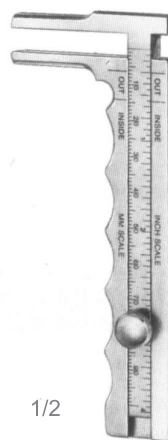

1/2

**AG.409.01**  
Townley  
Examination and  
measuring Instruments

AG.409.01  
10,0 cm - 4"

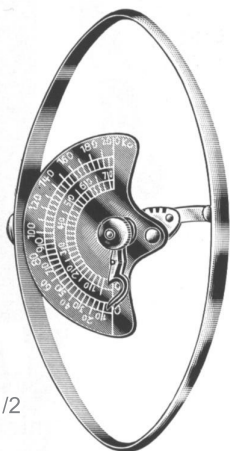

1/2

**AG.410.01/03**  
Collin  
Examination and  
measuring Instruments

AG.410.01/03  
12,5 cm - 5"

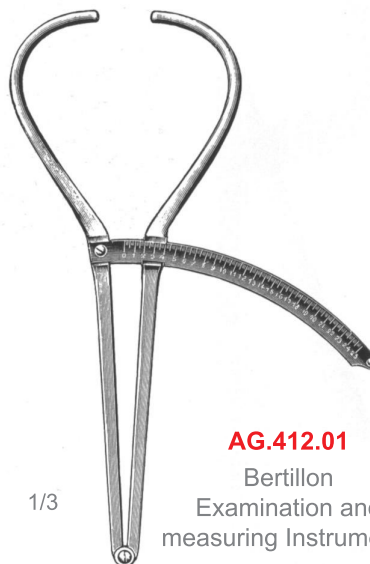

1/3

**AG.412.01**  
Bertillon  
Examination and  
measuring Instruments

- AG.408.01 Finger-Goniometer
- AG.409.01 Caliper
- AG.410.01 Dynamometer, graduated in Kg, for children
- AG.410.02 Ditto, for adults
- AG.410.03 Ditto, graduated in lbs., for adults
- AG.412.01 Cephalometer (Caliper)

AG

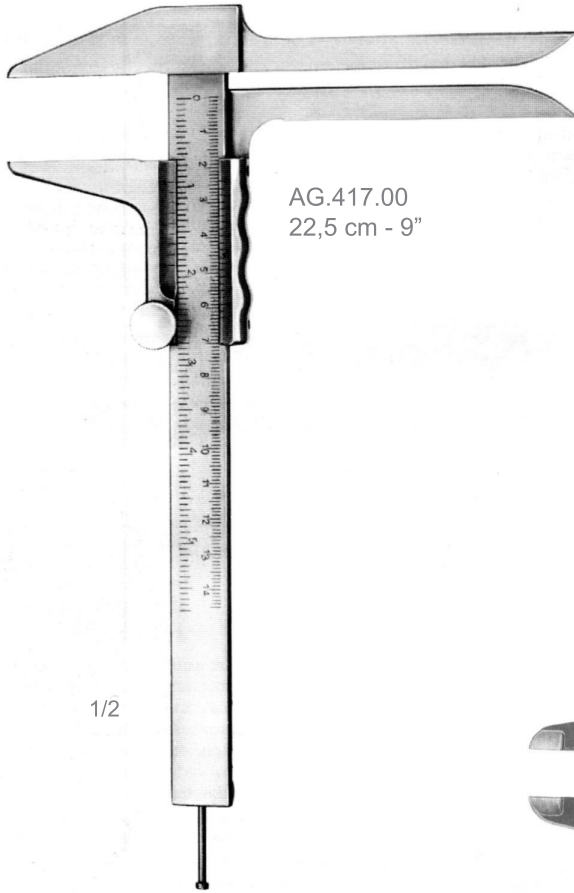

AG.417.00  
22,5 cm - 9"

1/2

**AG.417.00**

Examination and  
measuring Instruments

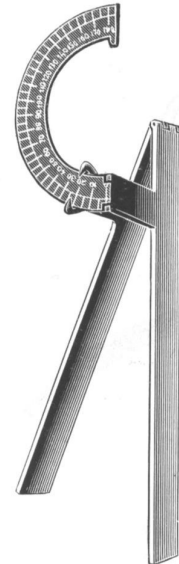

1/3

**AG.414.01**

Moeltgen  
Examination and  
measuring Instruments

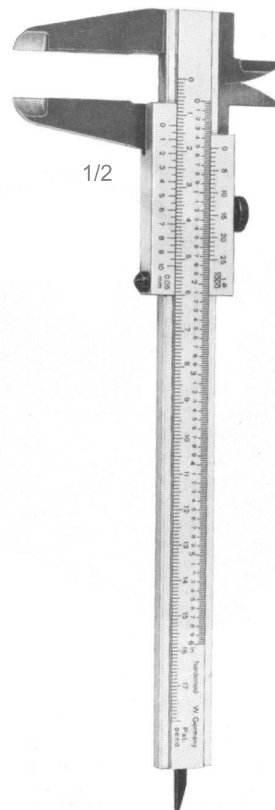

1/2

**AG.415.21**

Examination and  
measuring Instruments

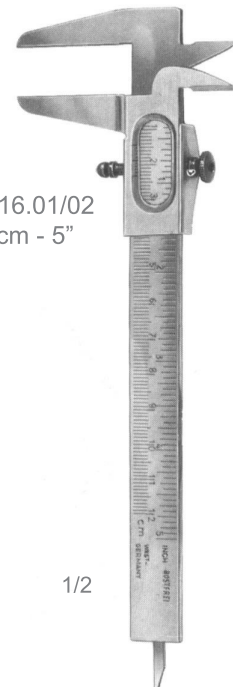

AG.416.01/02  
12,0 cm - 5"

1/2

**AG.416.01/02**

Vernier  
Examination and  
measuring Instruments

- AG.414.01 Goniometer (Flexometer)
- AG.415.21 Caliper of aluminium, graduated in mm and inches up to 180 mm / 6" measuring range up to 139 mm / 4 3/4", with parallax-free vernier 1/20 mm at 39 mm and 1/1000"
- AG.416.01 Universal Caliper of steel, graduated in millimeters and inches, measuring up to 120 mm / 5", with vernier in 1/10 mm and 1/16"
- AG.416.02 Ditto, of plastic

1/2



**AG.418.15/50**

Measuring Instruments,  
 Pulse Glasses

- AG.418.15 15 cm - 6"
- AG.418.20 20 cm - 8"
- AG.418.30 30 cm - 12"
- AG.418.50 50 cm - 20"

1/2

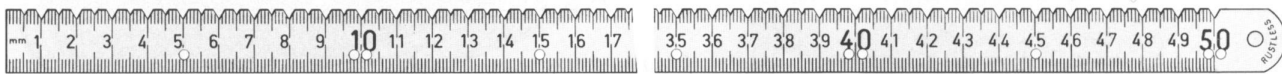

**AG.419.50**

Measuring Instruments,  
 Pulse Glasses

AG.419.50 50 cm - 20"  
 X-Ray

1/2



**AG.422.15**

Measuring Instruments,  
 Pulse Glasses

AG.422.15 15 cm - 6"

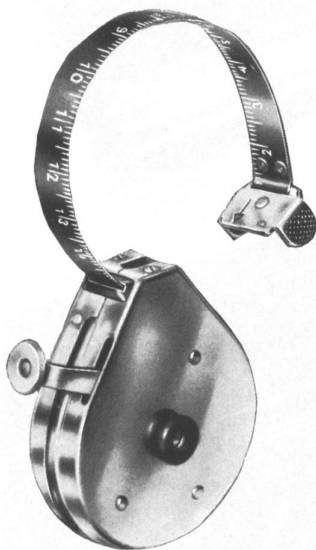

**AG.420.15**

Circumeter®  
 Measuring Instruments,  
 Pulse Glasses



**AG.425.15**  
**AG.427.15**

Measuring Instruments,  
 Pulse Glasses



**AG.430.15**

Measuring Instruments,  
 Pulse Glasses

**AG**

**AG.438.01**

Diagnostic Set complete, consisting of metal battery handle (without battery), 5 ear and 1 nasal specula, all of nylon, boilable and autoclavable 1 bulb, speculum holder, 1 wire spatula and 2 wooden spatulas in plastic case with zip fastener.

**AG.438.01**

Otorhinolux  
Diagnostic Sets



**AG.440.01**

Otoscope Set, consisting of battery handle (without batteries), 3 ear specula, 1 bulb, in velvet lined case.

**AG.440.01**

Diagnostic Sets



**AG.441.01**

Universal Diagnostic Set, ENT, complete, consisting of battery handle (without batteries), 3 ear specula, 1 nasal specula, 2 laryngeal mirrors with holders, 1 tongue depressor holder, 2 bulbs, in velvet lined case.

**AG.441.01**

Halnaso  
Diagnostic Sets



**AG.442.02**

Diagnostic Sets

**AG.442.02**

Ophthalmoscope Set, consisting of battery handle (without batteries), 1 ophthalmoscope with stepless focusing, 1 illumination lens, 1 bulb, 1 case.



**AG.430.02**

Diagnostic Sets

**AG.443.02**

Combination Diagnostic Set, consisting of battery handle (without batteries), 1 otoscope with 5 ears specula, 1 ophthalmoscope with stepless focusing, 2 bulbs in case.







1/3

**AG.444.02**  
Universal  
Diagnostic Sets



**AG.447.00**  
Diagnostic Sets

1/1



**AG.448.01**  
Diagnostic Sets



**AG.448.02**  
Diagnostic Sets



**AG.448.03**  
Diagnostic Sets



**AG.448.04**  
Diagnostic Sets



**AG.448.05**  
Diagnostic Sets

AG.442.02 Universal Diagnostic Set for EENT, consisting of battery handle (without batteries), 1 otoscope with 3 ear specula, 1 ophthalmoscope with stepless focusing, 1 nasal speculum, 2 laryngeal mirrors with holder, 1 tongue depressor holder, 2 bulbs, in case.

AG.447.00 Battery handle for Diagnostic Sets.

AG.448.01 Spare bulb for otoscope, tongue depressor holder, lamp carrier, laryngeal mirrors

AG.448.02 Spare bulb for May ophthalmoscope

AG.448.03 Spare bulb for ophthalmoscope

AG.448.04 Halogen bulb for otoscope

AG.448.05 Halogen bulb for ophthalmoscope



**AG.450.09/10**  
Ziegler  
Head Mirrors

1/2

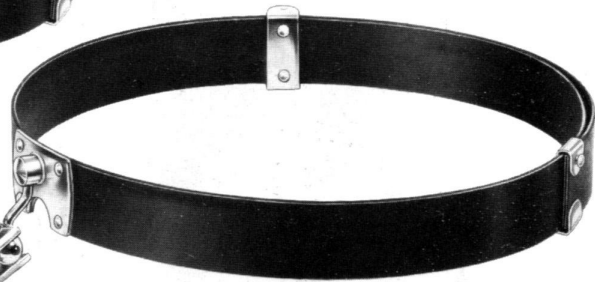

**AG.451.09/10**  
Head Mirrors

1/2

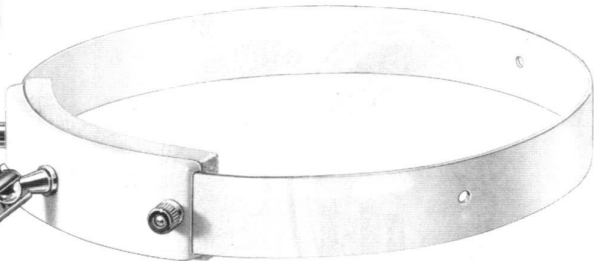
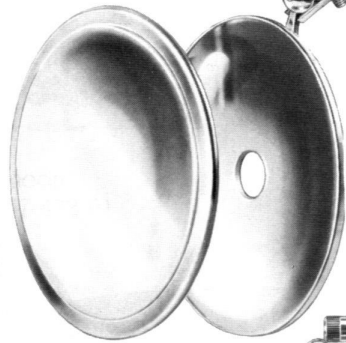

**AG.452.09/10**  
Ziegler  
Head Mirrors

1/2



- AG.450.09 Ziegler Head Mirror, complete with black head band AG.471.01, with socket-joint, 90 mm Ø, without protecting cover
- AG.450.10 Ditto, 100 mm Ø
- AG.451.09 Ziegler Head Mirror 1, with black fibre head band AG.471.01, socket-joint, 90 mm Ø, with protecting cover
- AG.451.10 Ditto, 100 mm Ø
- AG.452.09 Ziegler Head Mirror 2, with narrow Martin-commoda head band AG.472.01, of withe celluloid, with socket-joint 90 mm Ø, with protecting cover
- AG.452.10 Ditto, 100 mm Ø

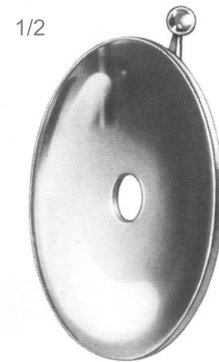

- AG.453.09 Ziegler Head Mirror 3, complete with broad Martin Commoda head band AG.473.01 of white celluloid, with ball socket, 90 mm Ø, with protecting cover.
- AG.453.10 Ditto, 100 mm Ø  
Ziegler Head Mirror, with fixed frame and protecting cover, only.
- AG.455.09 90 mm c
- AG.455.10 100 mm Ø  
Ziegler Reflector, only, with fixed aluminium frame, without protecting cover
- AG.456.09 90 mm Ø
- AG.456.10 100 mm Ø

1/2



**AG.471.00/01**

Head Mirrors

1/2



**AG.472.02/01**

Martin-commoda  
Head Mirrors

1/2

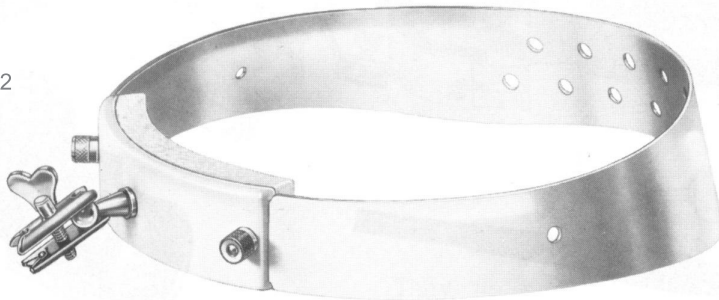

**AG.473.00/01**

Martin-commoda  
Head Mirrors

1/1

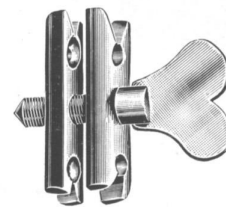

**AG.475.01**

Head Mirrors

Head Band of black fibre, 24 mm wide

AG.471.00 Without socket joint

AG.471.01 With socket joint

Martin-commoda-Head Band of wide celluloid, 23 mm wide,  
with soft rubber pad

AG.472.00 Without socket joint

AG.472.01 With socket joint

Martin-commoda-Head Band of wide celluloid, broad and  
anatomical shape, with soft rubber pad.

AG.473.00 Without socket joint

AG.473.01 With socket joint

AG.475.01 Socket joint for head bands only

1/2

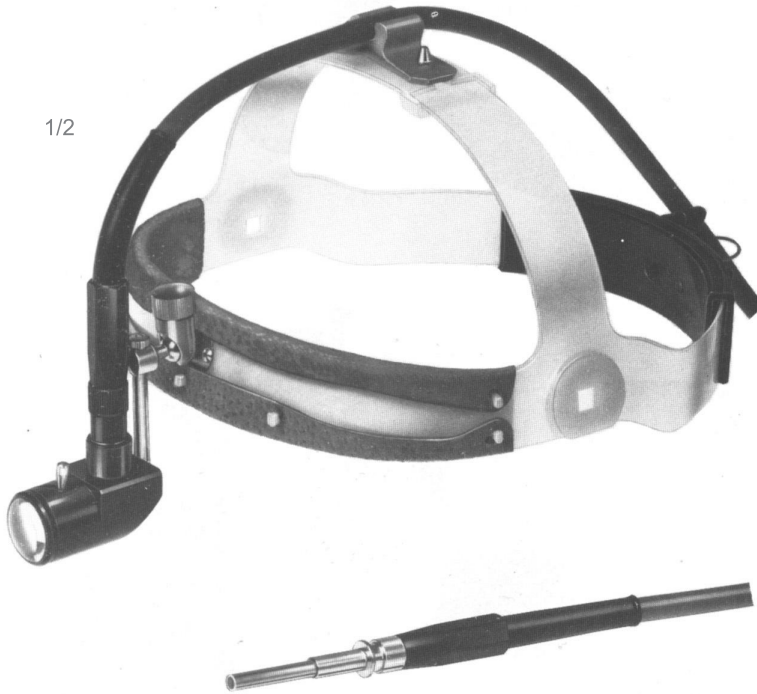

**AG.501.02**

Cold light head lamps

1/1

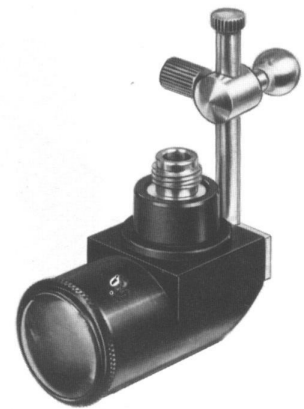

**AG.501.21**

Cold light head lamps

- AG.501.02 Cold Light Head Lamp, adjustable with build in condensor sistem focusing from 20 to 150 mm to height of eyes  
With fiber optic cable 180 cm, complete
- AG.501.21 Lamp Housing, focusing, only
- AG.501.25 Fiber optic clable 3.4 mm, 180 cm
- AG.501.30 Head Band only
- AG.502.10 Adaptor for ACM British Standard
- AG.502.20 Ditto, for Henke-Sass, Wolf
- AG.502.30 Ditto, for Storz
- AG.502.40 Ditto, for Winter & Ibe
- AG.502.50 Ditto, for Vision
- AG.502.60 Ditto, for Welch Allyn

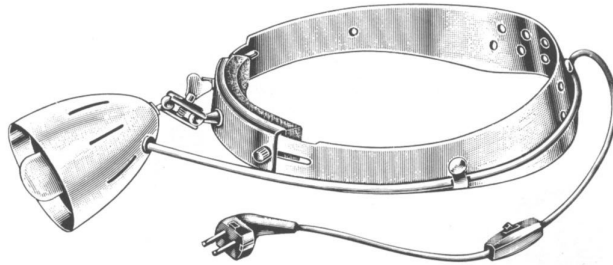

AG.504.22  
220 volt

**AG.504.22**

Martin Orion  
Head Lamps

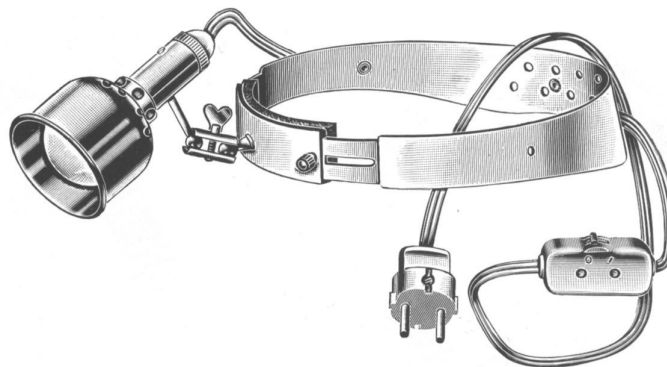

AG.514.22  
220 volt

**AG.514.22**

Thiry  
Head Lamps

- AG.504.22 Martin Orion Head Lamp 3, complete, consisting of: head lamp with mirror reflector, Martin-commoda head band, broad and anatomical shape of wide celluloid, with cable clips and socket joint, cable 3 m. long, with intermediate switch.
- AG.505.22 Spare Bulb 15 watts / 220 volts
- AG.514.22 Thiry Head Lamp 3, complete, consisting of: head lamp with mirror reflector Martin-commoda head band broad anatomical shape of white celluloid with cable clips and socket joint, cable 3 m. long with intermediate switch
- AG.515.22 Spare Bulb 25 watts / 220 volts

AG



**AG.517.04/06**  
Head Lamps for low voltage current

AG.517.04 4 volts  
AG.517.06 6 volts

AG.518.01  
Glass Mirror,  
without frame for  
AG.517.04/06



**AG.518.01**  
Head Lamps for low voltage current



**AG.520.04/06**  
**AG.524.04**  
**AG.526.01**  
Clar  
Head Lamps for low voltage current



**AG.526.01**  
Head Lamps for low voltage current

## Head Lamps for low voltage current

STIRNLAMPEN FÜR SCHWACHSTROM

LÁMPARAS FRONTALES PARA CORRIENTE DE BAJA TENSIÓN

# Kolpen

DIAGNOSTICS

DIAGNOSTIK-BESTECKE

JUEGOS PARA DIAGNÓSTICO

**AG**



**AG.523.04/06**

**AG.524.04**

**AG.527.01**

Clar  
Head Lamps for low  
voltage current

Clar Head Lamp 3, complete, with Martin-commoda head band,  
broad and anatomical shape, of white celluloid

AG.523.04 For 4 volts

AG.523.06 For 6 volts

Clar Head Lamp, with cable socket and reflector (without head  
band and without socket join)

AG.524.04 For 4 volts

AG.524.06 For 6 volts

AG.525.01 Clar Reflector of glass, without frame

AG.525.02 Clar special socket join

AG.525.04 Spare Bulb 4 volts

AG.525.06 Ditto 6 volts

AG.526.01 Clar Spring Metal Head Band only, with cable clips and fixing  
screw with socket join

AG.527.01 Martin-commoda Head Band of white celluloid, broad and ana-  
tomical shape, soft rubber pad, cable clips, with fixing screw for  
Clar socket join and socket join



4 Volt or 6 Volt  
Adjustable focus

1/3

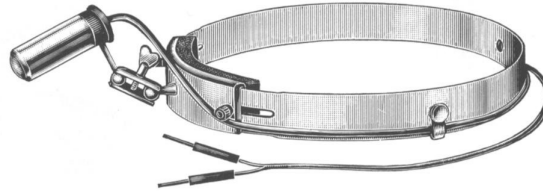

**AG.532.04/06**

Mod. Martin  
Head Lamps for low  
voltage current

1/3

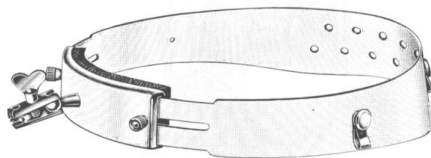

**AG.542.00/01**

Martin-commoda  
Head Lamps for low  
voltage current

1/3

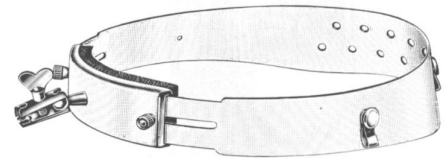

**AG.543.00/01**

Martin-commoda  
Head Lamps for low  
voltage current

Head lamp for low tension current 2, Martin pattern, complete, consisting of: head lamp with adjustable focus and cable, Martin-commoda head band, narrow of white celluloid, with cable clips and socket join

AG.532.04 For 4 volts

AG.532.06 For 6 volts

Head Lamp for low current tension 3, Martin pattern, complete, as above, but with Martin-commoda head band, broad and anatomical shape

AG.533.04 For 4 volts

AG.533.06 For 6 volts

Martin-commoda head band of white celluloid soft rubber pad and cable clips

AG.542.00 Without socket join 23 mm wide

AG.542.01 With socket join 23 mm wide

AG.543.00 Without socket join broad and anatomical shape

AG.543.01 With socket join broad and anatomical shape

## Accessories for Head Lamps

ZUBEHÖR FÜR SCHWACHSTROMLAMPEN - ACCESORIOS PARA  
LÁMPARAS FRONTALES

# Kolpen

DIAGNOSTICS  
DIAGNOSTIK-BESTECKE  
JUEGOS PARA DIAGNÓSTICO

**AG**

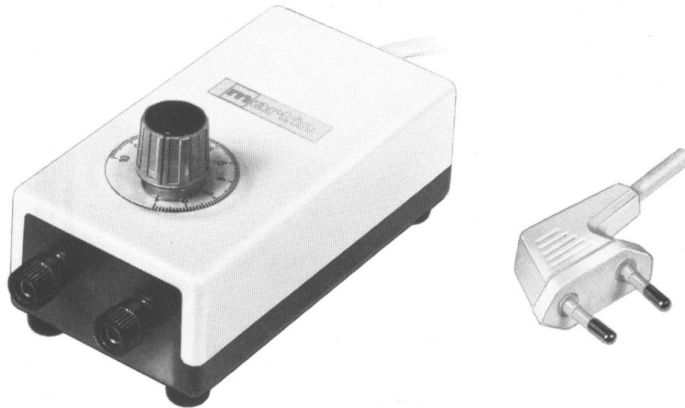

AG.578.01  
220 volt = 0-10 volt / 3 watt

### **AG.578.01**

Accessories for Head  
Lamps

AG.578.01 Mini-Transformer Unit for 220 volts alternating current, with cable and outlet for low voltage current, stepless regulation from 0-10 volts



1/2

### AG.580.01

Intra-operative  
Illuminators

AG.580.01  
23,0 cm - 9"



1/2

### AG.580.02

Intra-operative  
Illuminators

AG.580.02  
26,0 cm - 10 1/4"  
45°



1/2

### AG.580.03

Intra-operative  
Illuminators

AG.580.03  
24,0 cm - 9 1/2"  
90°

## Eclaireur buccal, Loupes

MUNDSTABLAMPEN, LUPEN, KOPFLUPEN - LÁMPARA PARA LA BOCA,  
LENTE DE AGRANDAMIENTO, LENTE FRONTAL

# Kolpen

DIAGNOSTICS  
DIAGNOSTIK-BESTECKE  
JUEGOS PARA DIAGNÓSTICO

**AG**



1/2

**AG.590.02**

Mulux  
Eclaireur buccal,  
Loupes

AG.590.02  
3 volt

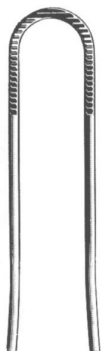

1/2

**AG.595.01**

Eclaireur buccal,  
Loupes



1/2

**AG.595.02**

Eclaireur buccal,  
Loupes

AG.595.02  
Of wood



1/2

**AG.595.03**

Eclaireur buccal,  
Loupes

AG.595.03  
2.5 volt



1/3

**AG.610.00/01**

Eclaireur buccal,  
Loupes

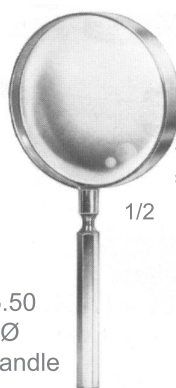

1/2

AG.625.50  
50 mm Ø  
Metal handle

**AG.625.50**

Eclaireur buccal,  
Loupes

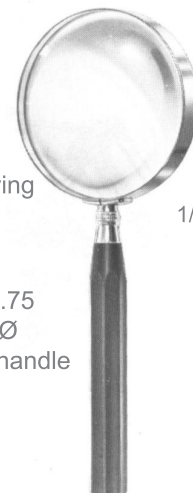

1/3

AG.627.75  
75 mm Ø  
Plastic handle

**AG.627.75**

Eclaireur buccal,  
Loupes

AG.590.02 Mulux Electric Lamp for examining the cavity of the mouth, complete with interchangeable wire depressor, 2 wooden depressors, 2 lenticular bulbs, in plastic pouch

AG.595.01 Wire Depressor, only

AG.595.02 Wooden Depressor, only

AG.595.03 Lenticular Bulb, only

AG.610.00 Binocular Loupe, magnifying 1,8 X, with Martin-commoda head band of white celluloid, free working distance about 40 cm, vision field 10 cm Ø. Working distance and size of field adjustable.

AG.610.01 Headband only

AG.625.50 Reading Glasses with metal frame and biconvex lens

AG.627.75 Reading Glasses with metal frame and biconvex lens

AG

1/2

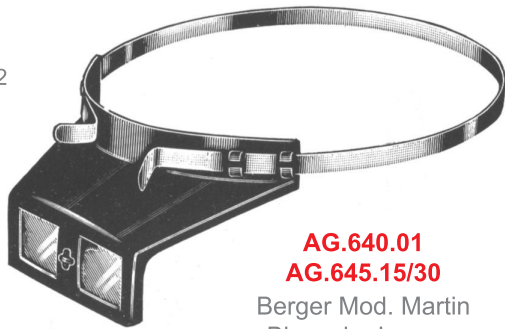

**AG.640.01**  
**AG.645.15/30**  
Berger Mod. Martin  
Binocular Loupes

1/2

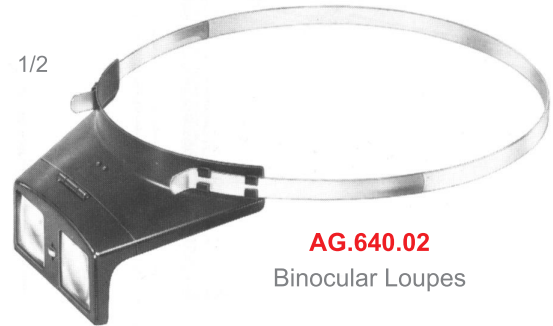

**AG.640.02**  
Binocular Loupes

1/2

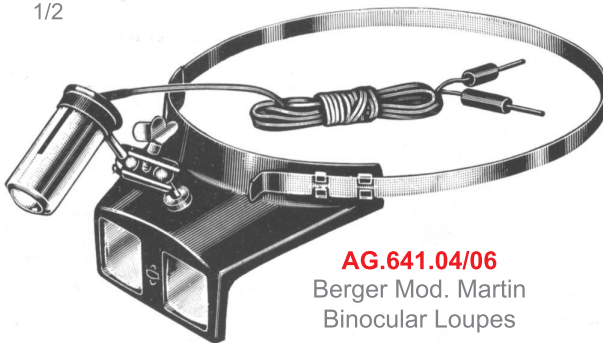

**AG.641.04/06**  
Berger Mod. Martin  
Binocular Loupes  
AG.641.04 4 Volt  
AG.641.06 6 Volt

1/1



**AG.645.15/30**  
Binocular Loupes

AG.640.01 Binocular Head Magnifier with 2 interchangeable prismatic lenses, magnification 2 1/2 X (at a working distance of about 130 mm = 5" = 7 diopters) in black enamelled metal frame, with adjustable spring-steel head band

AG.640.02 Ditto, swivel

AG.641.04 Ditto, combined with Martin head-lamp for low tension current, with adjustable focus, cable and plug, for 4 volts

AG.641.06 Ditto, for 6 volts  
Twin Lens for Berger magnifier

#### Magnification / working distance

|           |         |                                  |
|-----------|---------|----------------------------------|
| AG.645.15 | 1 1/2 X | 220 mm (8 3/4") = 4 diopters     |
| AG.645.20 | 2 X     | 170 mm (6 3/4") = 5 1/2 diopters |
| AG.645.25 | 2 1/2 X | 130 mm (5") = 7 diopters         |
| AG.645.30 | 3 X     | 100 mm (4") = 8 1/2 diopters     |



**AG.690.00**

Blood Extraction  
AG.690.00  
Package of 500 ea.



1/1



1/2

**AG.747.15**  
**AG.747.25**

Martin-Alcospend  
Freund  
Blood Extraction

AG.747.15 150 cm3  
AG.747.25 250 cm3



**AG.800.01/02**

Novapress  
Blood Extraction



**AG.801.01/02**

Martin-Pressofix  
Blood Extraction

Martin-Alcospend One-hand Alcohol Dispenser for moistening cotton wool and swabs, with alcohol-proof pressure lock, metal pump device with thread

AG.747.15 Complete, with brown bottle 150 cc.

AG.747.25 Complete, with brown bottle 250 cc.

Spare bottle with thread, only

AG.749.15 Brown 150 cc.

AG.749.25 Brown 250 cc.

AG.800.01 Novapress Tourniquet, with solid rubber bandage 15 mm wide with metal lock

AG.800.02 Spare Solid Rubber Bandage, only

AG.801.01 Martin-Pressofix Tourniquet with elastic web strap bandage 30 mm wide, with metal fittings

AG.801.02 Spare Bandage, only



**AG.805.00/04**  
Comprimeter

- AG.805.00 Comprimeter. Compression apparatus for producing blood vacuum in the extremities. Manometer gauge adjusted until 700 mm Hg. Air pump with one cuff for the leg and one cuff for the arm.
- AG.805.01 Cuff A (Upper arm)
- AG.805.02 Cuff B (Leg)
- AG.805.03 Air Pump
- AG.805.04 Manometer

## Blood Pressure Manometers

BLUDDRUCKMEßAPPARATE - MANÓMETRO DE MERCURIO PARA LA PRESIÓN DE SANGRE

# Kolpen

DIAGNOSTICS  
DIAGNOSTIK-BESTECKE  
JUEGOS PARA DIAGNÓSTICO

**AG**

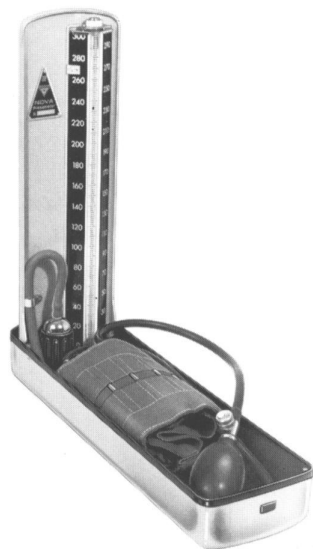

**AG.960.00**  
**AG.966.00**

Blood Pressure  
Manometers



1/3

**AG.970.00**  
**AG.976.00**

Blood Pressure  
Manometers

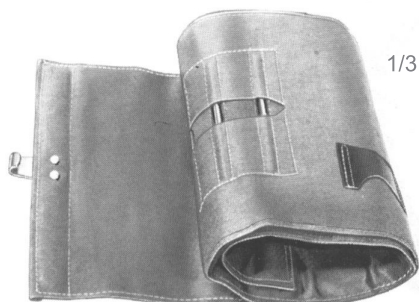

1/3

**AG.980.00**

Blood Pressure  
Manometers

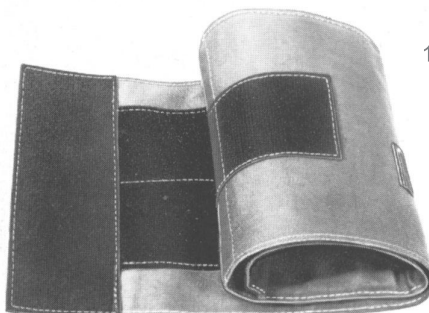

1/3

**AG.982.00**

Blood Pressure  
Manometers



1/3

**AG.984.00**

Blood Pressure  
Manometers

- AG.960.00 Mercury Blood Pressure Manometre, in case, with mercury tube 300 mm, calibrated, with hook cuff.
- AG.962.00 Ditto, calibrated with velcro cuff
- AG.964.00 Ditto, not calibrated, with hook cuff
- AG.966.00 Ditto, not calibrated, with velcro cuff
- AG.970.00 Blood Pressure Manometre, in pouch, calibrated, with hook cuff
- AG.972.00 Ditto, calibrated, with velcro cuff
- AG.974.00 Ditto, not calibrated, with hook cuff
- AG.976.00 Ditto, not calibrated, with velcro cuff
- AG.980.00 Hook cuff, only, for AG.960.00 / AG.964.00
- AG.982.00 Velcro cuff, only, for AG.962.00 / AG.966.00
- AG.983.00 Hook cuff, only, for AG.970.00 and AG.974.00
- AG.983.05 Velcro cuff, only, for AG.972.00 and AG.976.00



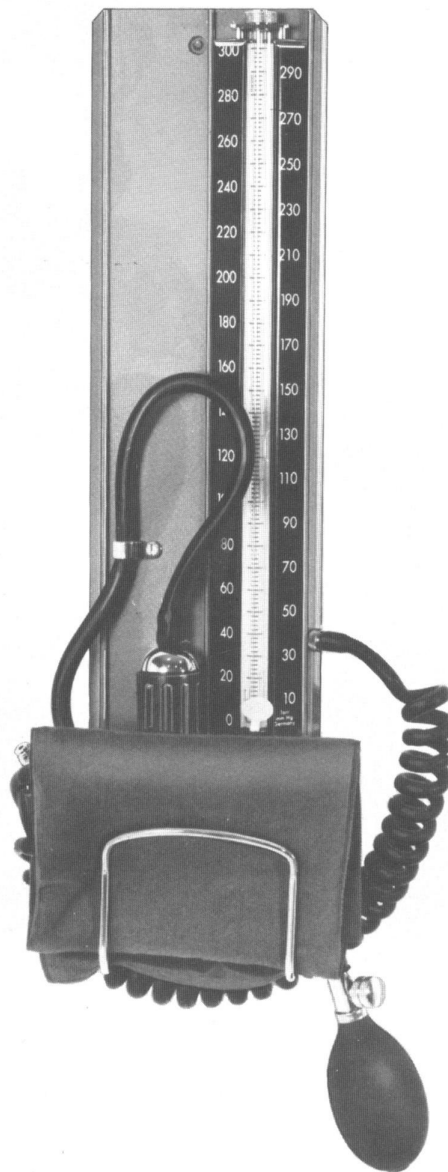

**AG.990.00**

**AG.994.00**

Blood Pressure  
Manometers

AG.990.00 With bandage cuff

AG.992.00 With hook cuff

AG.994.00 With velcro cuff