

# Kolpen

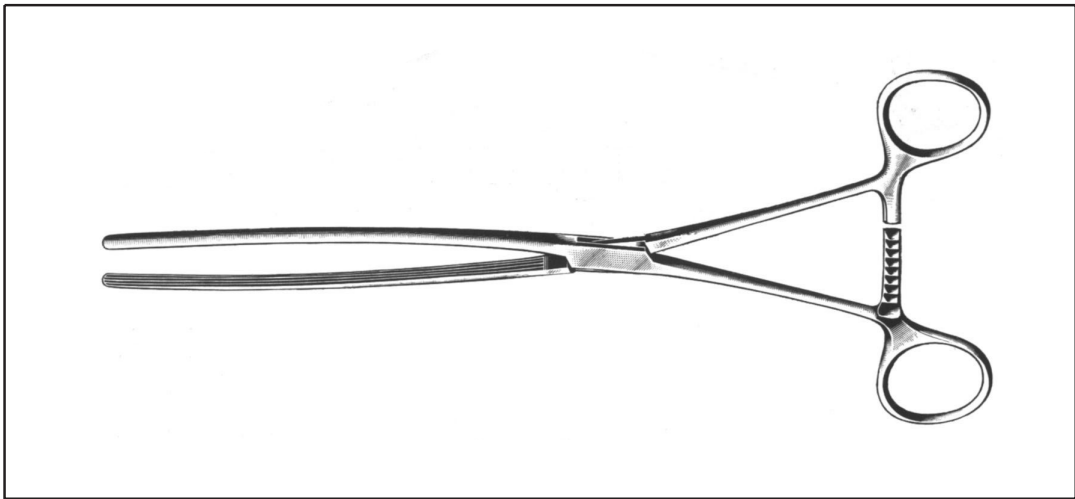

---

**CK**



**CK**



**CK.130.12**

Allis-Baby  
Tissue and Organ  
Holding Forceps

4 : 5

1/1

CK.130.12  
12,0 cm - 4 1/2"  
4:5 Teeth

4 : 5  
1/1   
CK.132.15  
15,0 cm - 6"



**CK.132.15**  
**CK.134.15/25**

Allis  
Tissue and Organ  
Holding Forceps

5 : 6  
  
CK.134.15  
15,0 cm - 6"  
CK.134.19  
19,0 cm - 7 1/2"  
CK.134.25  
25,0 cm - 10"

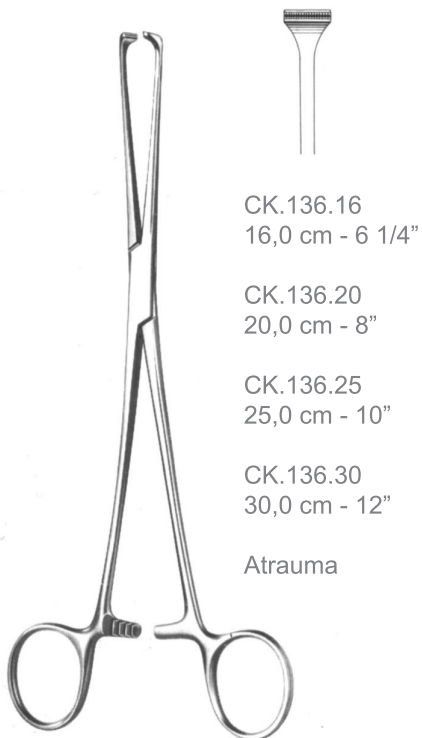

**CK.136.16/30**

Allis-Atrauma  
Tissue and Organ  
Holding Forceps

CK.136.16  
16,0 cm - 6 1/4"

CK.136.20  
20,0 cm - 8"

CK.136.25  
25,0 cm - 10"

CK.136.30  
30,0 cm - 12"

Atrauma



**CK.138.15**

Allis-Adair  
Tissue and Organ  
Holding Forceps

CK.138.15  
15,5 cm - 6"  
10:11 Teeth

1/2

1/1

# Tissue and Organ Holding Forceps

GEWEBE- UND ORGAN-FABZANGEN - PINZAS PARA TEJIDOS Y ÓRGANOS

# Kolpen

INTESTINES, STOMACH, RECTUM  
DARM, MAGEN, MASTDARM  
INTESTINOS, ESTÓMAGOS, RECTO

**CK**



CK.142.15  
15,0 cm - 6"

**CK.142.15**  
Boys-Allis  
Tissue and Organ  
Holding Forceps

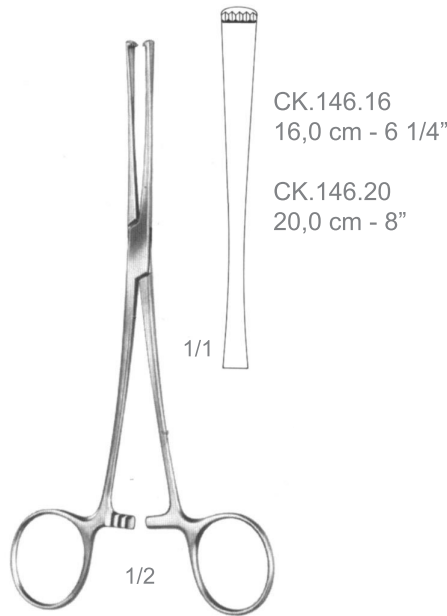

CK.146.16  
16,0 cm - 6 1/4"  
CK.146.20  
20,0 cm - 8"

**CK.146.16/20**  
Lockwood-Allis  
Tissue and Organ  
Holding Forceps

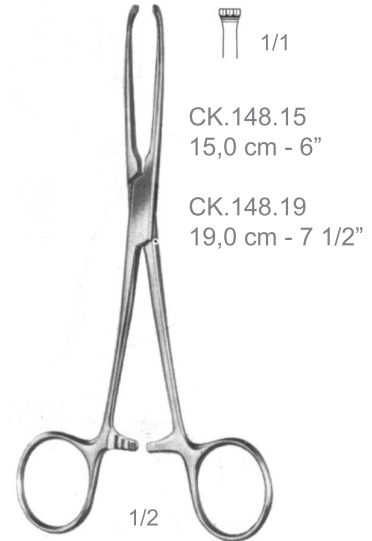

CK.148.15  
15,0 cm - 6"  
CK.148.19  
19,0 cm - 7 1/2"

**CK.148.15/19**  
Judd-Allis  
Tissue and Organ  
Holding Forceps



CK.150.20  
20,0 cm - 8"

**CK.150.20**  
Thoms-Allis  
Tissue and Organ  
Holding Forceps



CK.154.20  
20,0 cm - 8"

**CK.154.20**  
Allis  
Tissue and Organ  
Holding Forceps

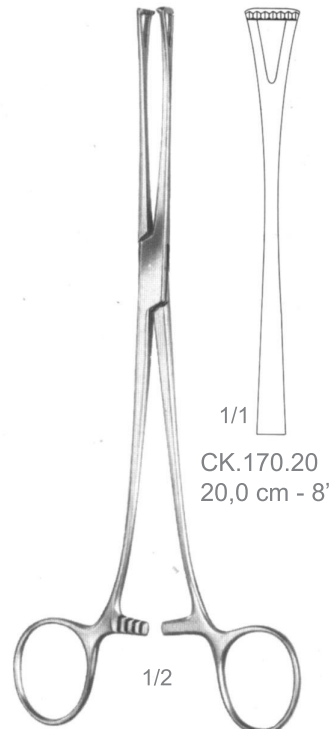

CK.170.20  
20,0 cm - 8"

**CK.170.20**  
Lockwood  
Tissue and Organ  
Holding Forceps

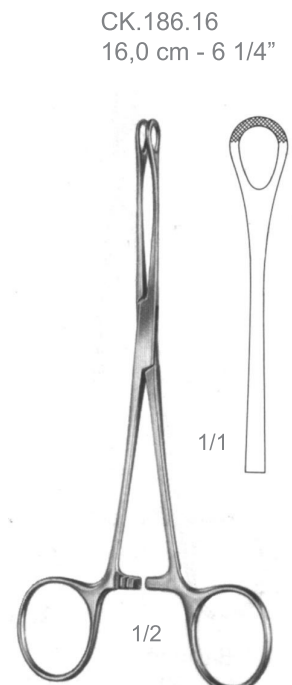

CK.186.16  
16,0 cm - 6 1/4"

**CK.186.16**  
Williams  
Tissue and Organ  
Holding Forceps

# Kolpen

INTESTINES, STOMACH, RECTUM  
DARM, MAGEN, MASTDARM  
INTESTINOS, ESTÓMAGOS, RECTO

## Tissue and Organ Holding Forceps

GEWEBE- UND ORGAN-FABZANGEN - PINZAS PARA TEJIDOS Y ÓRGANOS

CK



\* Firm and gentle grip of tissues without traumatizing effect

\* Firm grip and longfile profile guaranteed

Kolpen **GOLD**



**CK.190.16/20**  
Babcock  
Tissue and Organ  
Holding Forceps

1/1

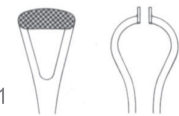

CK.190.16  
16,0 cm - 5 1/2"  
Normal Profile

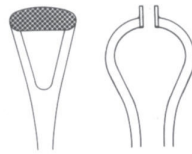

CK.190.20  
20,0 cm - 8"  
Normal Profile



**CK.206.20**  
Duval  
Tissue and Organ  
Holding Forceps

1/1



CK.206.20  
20,0 cm - 8"  
Normal Profile

1/2

Tissue and Organ Holding Forceps

GEWEBE- UND ORGAN-FABZANGEN - PINZAS PARA TEJIDOS Y ÓRGANOS

# Kolpen

INTESTINES, STOMACH, RECTUM  
DARM, MAGEN, MASTDARM  
INTESTINOS, ESTÓMAGOS, RECTO

**CK**



**CK.192.16/24**  
Babcock  
Tissue and Organ  
Holding Forceps



- CK.192.16  
16,0 cm - 6 1/4"
- CK.192.18  
18,0 cm - 7"
- CK.192.20  
20,0 cm - 8"
- CK.192.24  
24,0 cm - 9 1/2"

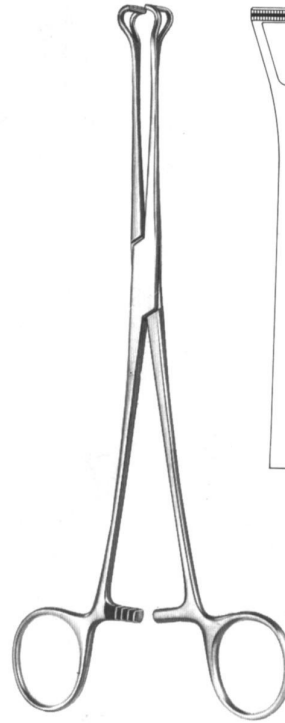

**CK.196.16/20**  
Babcock-Atrauma  
Tissue and Organ  
Holding Forceps



- CK.196.16  
16,0 cm - 6 1/4"
- CK.196.20  
20,0 cm - 8"
- Atrauma

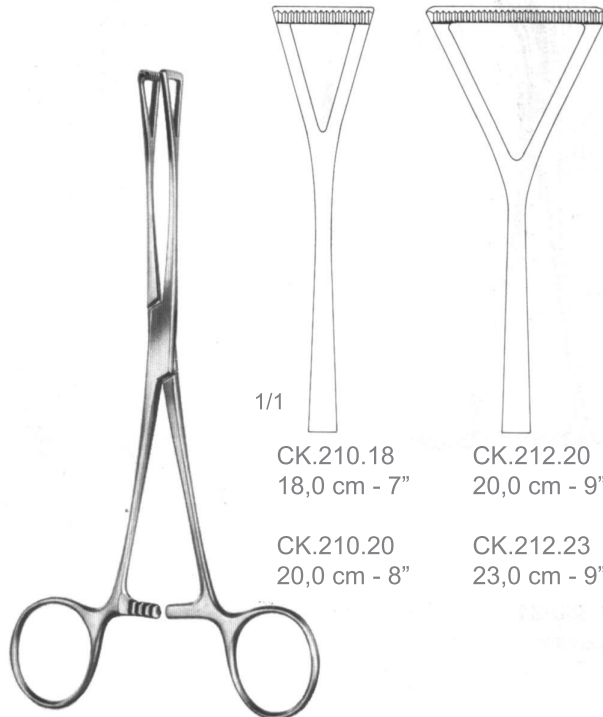

**CK.210.18/20**  
**CK.212.20/23**  
Duval  
Tissue and Organ  
Holding Forceps

- 1/1
- CK.210.18  
18,0 cm - 7"
- CK.210.20  
20,0 cm - 8"
- CK.212.20  
20,0 cm - 9"
- CK.212.23  
23,0 cm - 9"

# Kolpen

INTESTINES, STOMACH, RECTUM  
DARM, MAGEN, MASTDARM  
INTESTINOS, ESTÓMAGOS, RECTO

## Intestinal Clamp Forceps

DARMKLEMMEN - PINZAS-CLAMPS INTESTINALES

CK

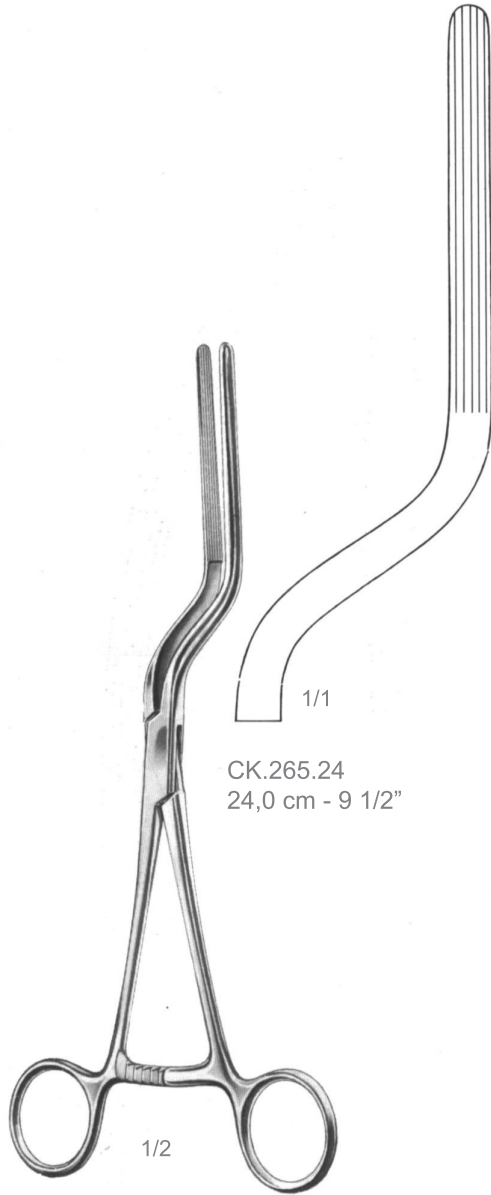

CK.265.24  
24,0 cm - 9 1/2"

**CK.265.24**  
Brunner  
Intestinal Clamp  
Forceps

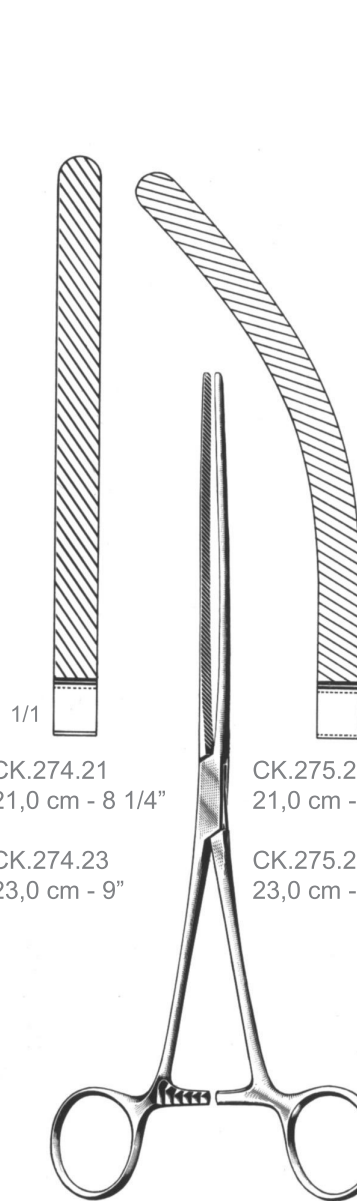

CK.274.21  
21,0 cm - 8 1/4"

CK.274.23  
23,0 cm - 9"

CK.275.21  
21,0 cm - 8 1/4"

CK.275.23  
23,0 cm - 9"

**CK.274.21/23**  
**CK.275.21/23**  
Doyen  
Intestinal Clamp  
Forceps

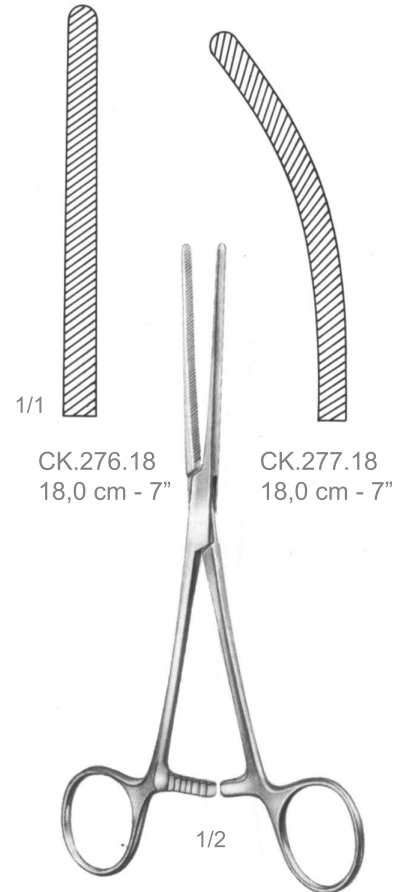

CK.276.18  
18,0 cm - 7"

CK.277.18  
18,0 cm - 7"

**CK.276.18**  
**CK.277.18**  
Baby-Doyen  
Intestinal Clamp  
Forceps

Intestinal Clamp Forceps

DARMKLEMMEN - PINZAS-CLAMPS INTESTINALES

# Kolpen

INTESTINES, STOMACH, RECTUM  
DARM, MAGEN, MASTDARM  
INTESTINOS, ESTÓMAGOS, RECTO

**CK**

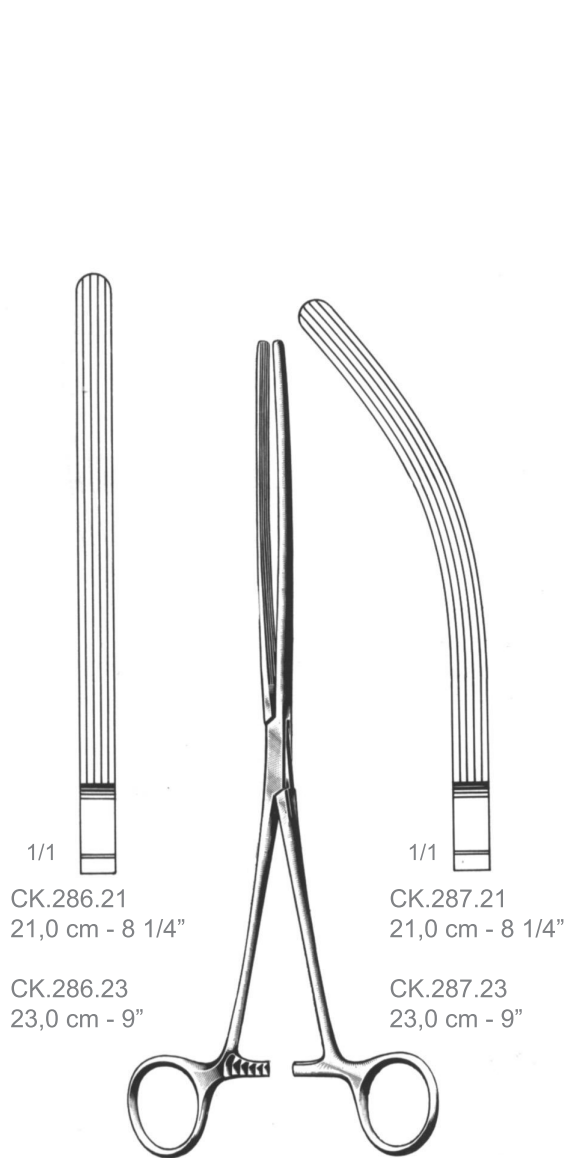

**CK.286.21/23**  
**CK.287.21/23**  
Mayo-Robson  
Intestinal Clamp  
Forceps

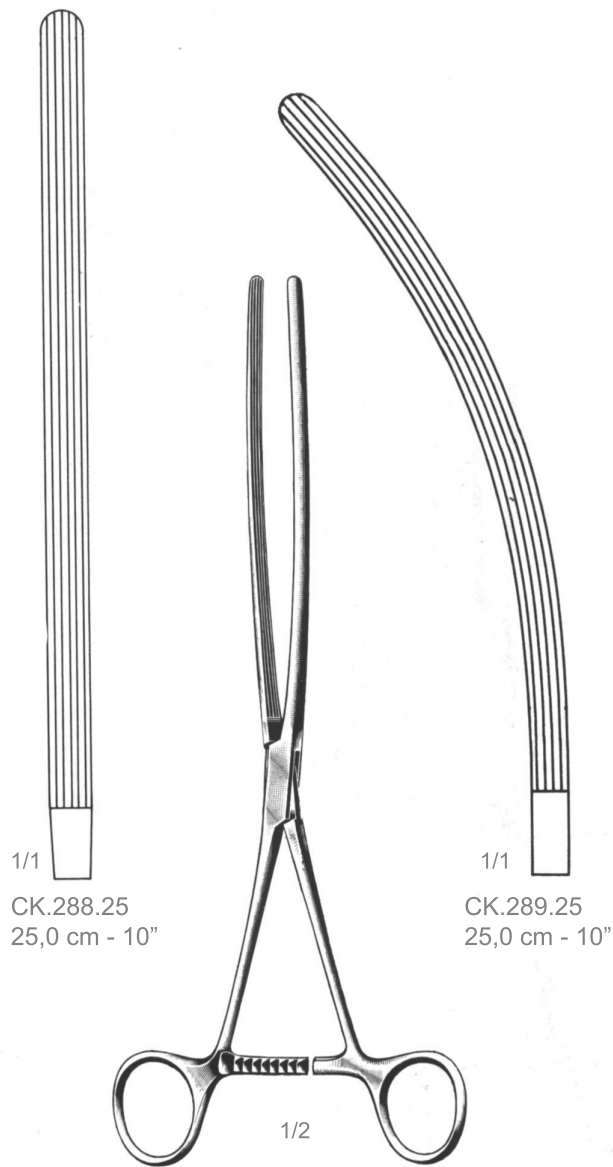

**CK.288.25**  
**CK.289.25**  
Mayo Robson  
Intestinal Clamp  
Forceps



CK

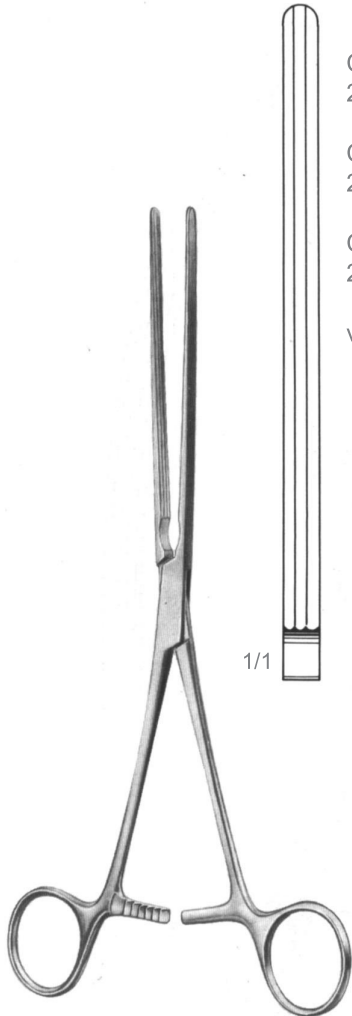

CK.304.22  
22,0 cm - 8 3/4"

CK.304.25  
25,0 cm - 10"

CK.304.28  
28,0 cm - 11"

very elastic

**CK.304.22/28**  
Kocher  
Intestinal Clamp  
Forceps

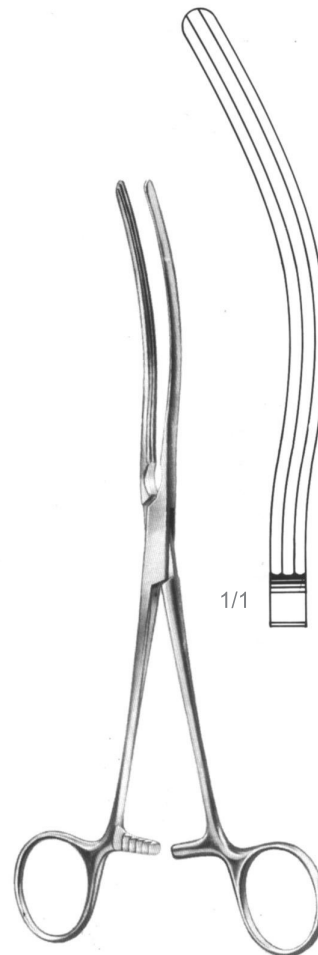

CK.305.22  
22,0 cm - 8 3/4"

CK.305.25  
25,0 cm - 10"

CK.305.28  
28,0 cm - 11"

very elastic

**CK.305.22/28**  
Kocher  
Intestinal Clamp  
Forceps

# Intestinal Clamp Forceps

DARMKLEMMEN - PINZAS-CLAMPS INTESTINALES

# Kolpen

INTESTINES, STOMACH, RECTUM  
DARM, MAGEN, MASTDARM  
INTESTINOS, ESTÓMAGOS, RECTO

CK

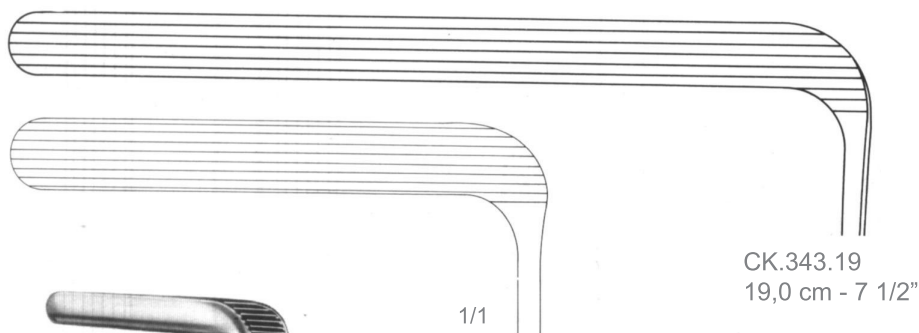

CK.343.19  
19,0 cm - 7 1/2"

CK.341.19  
19,0 cm - 7 1/2"



**CK.341.19**  
**CK.343.19**  
Mikulicz  
Intestinal Clamp  
Forceps

CK.352.25  
25,0 cm - 10"

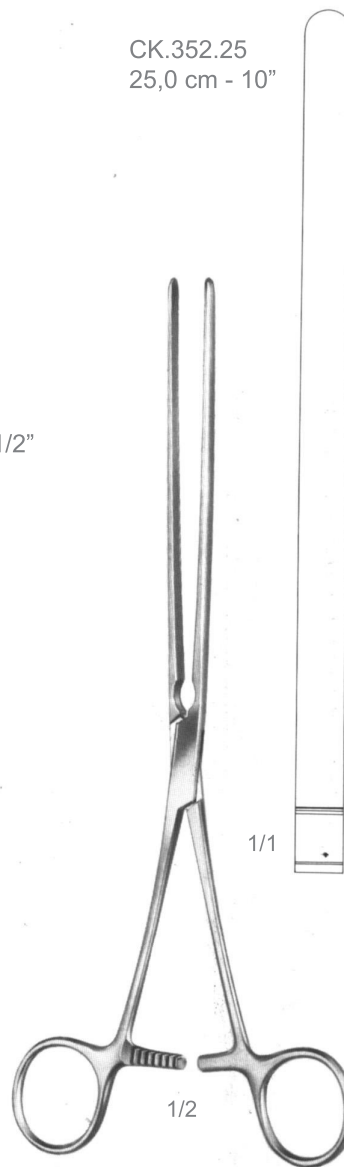

**CK.352.25**  
Scudder  
Intestinal Clamp  
Forceps

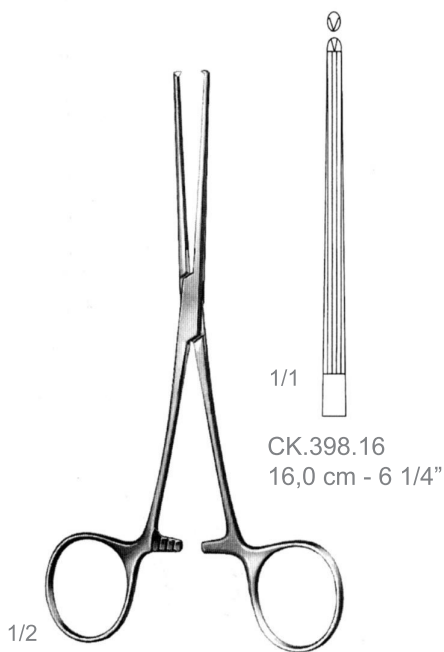

CK.398.16  
16,0 cm - 6 1/4"

**CK.398.16**  
Allen  
Intestinal Clamp  
Forceps

# Kolpen

INTESTINES, STOMACH, RECTUM  
DARM, MAGEN, MASTDARM  
INTESTINOS, ESTÓMAGOS, RECTO

## Intestinal and Stomach Clamps (Crushing Clamps)

DARM- UND MAGENQUETSCHKLEMMEN - PINZAS-CLAMPS INTESTINALES Y ESTOMACALES

CK

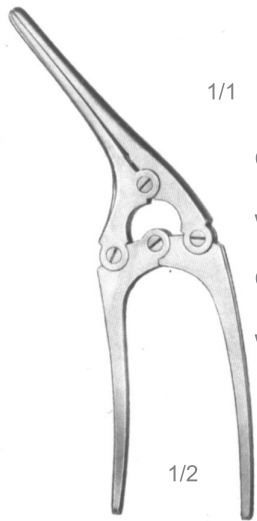

1/1



CK.413.15  
15,0 cm - 6"  
without pin

CK.415.15  
15,0 cm - 6"  
with pin

1/2

**CK.413.15**  
**CK.415.15**  
Payr-Baby  
Intestinal and  
Stomach Clamp

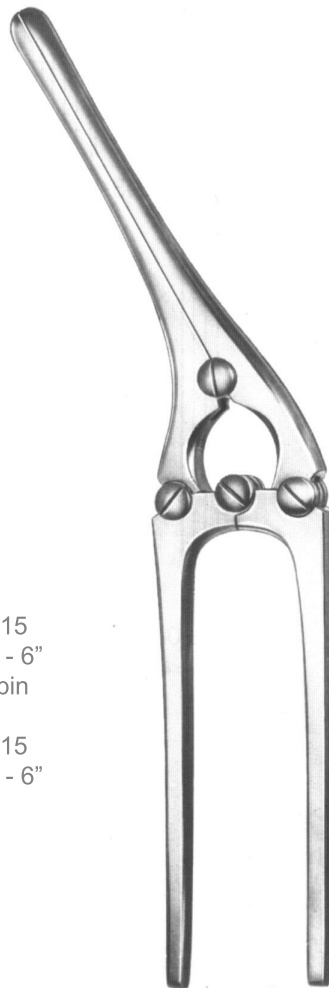

1/1



CK.417.21  
21,0 cm - 8 1/4"  
without pin

CK.419.21  
21,0 cm - 8 1/4"  
with pin

**CK.417.21**  
**CK.419.21**  
**CK.423.29**  
**CK.425.29**  
**CK.431.35**  
**CK.433.35**

Payr  
Intestinal and  
Stomach Clamp

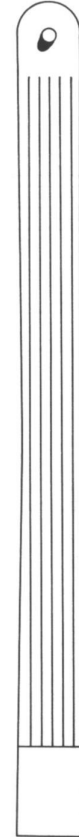

CK.423.29  
29,0 cm - 11 1/2"  
without pin

CK.425.29  
29,0 cm - 11 1/2"  
with pin

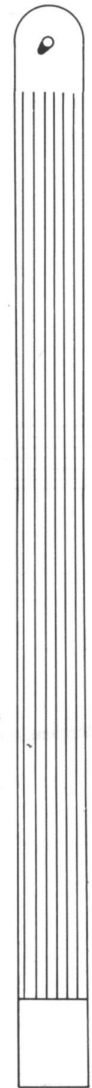

CK.431.35  
35,0 cm - 13 3/4"  
without pin

CK.433.35  
35,0 cm - 13 3/4"  
with pin

# Stomach Clamp Forceps

MAGENKLEMMEN - PINZAS-CLAMPS ESTOMACALES

# Kolpen

INTESTINES, STOMACH, RECTUM  
DARM, MAGEN, MASTDARM  
INTESTINOS, ESTÓMAGOS, RECTO

**CK**



**CK.448.33**  
**CK.449.33**

Scudder  
Stomach Clamp  
Forceps

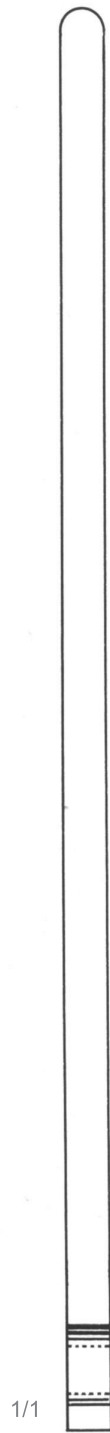

CK.448.33  
33,0 cm - 13"  
Smooth Jaws

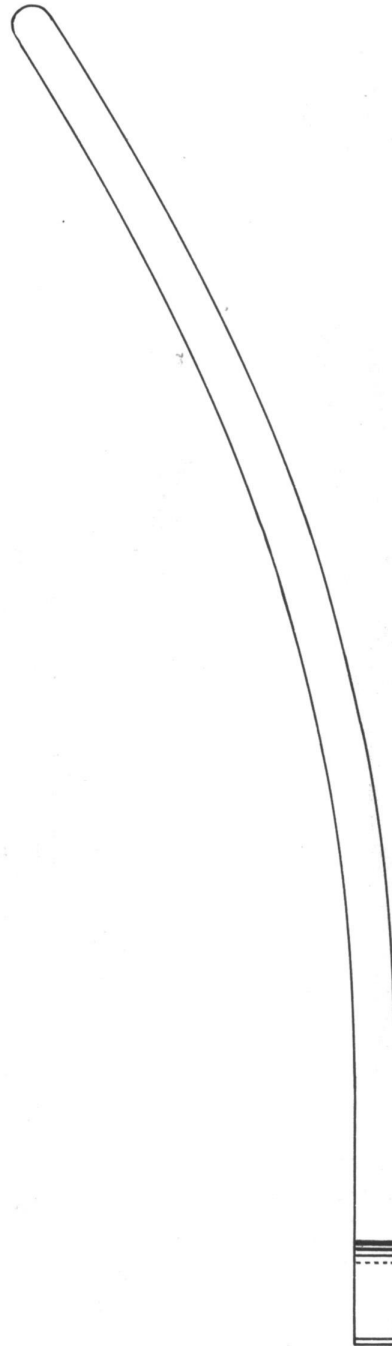

CK.449.33  
33,0 cm - 13"  
Smooth Jaws

# Kolpen

INTESTINES, STOMACH, RECTUM  
DARM, MAGEN, MASTDARM  
INTESTINOS, ESTÓMAGOS, RECTO

## Stomach Clamp Forceps

MAGENKLEMMEN - PINZAS-CLAMPS ESTOMACALES

CK

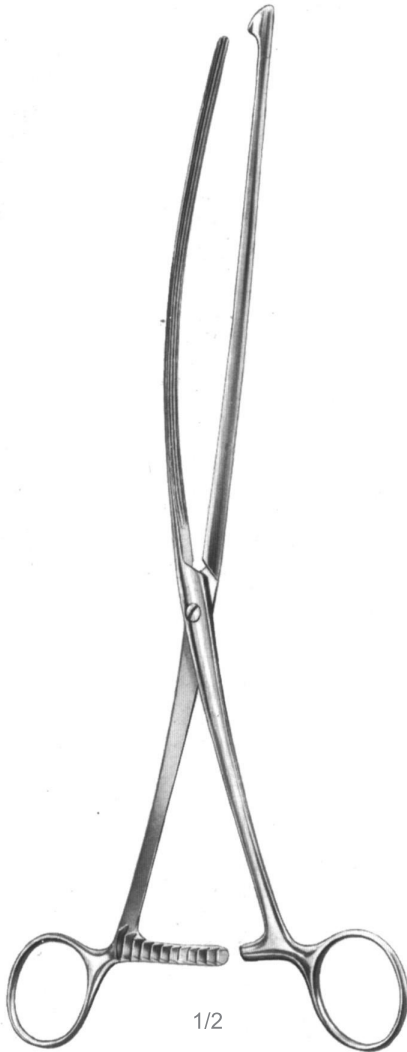

CK.464.30  
CK.465.30  
Nußbaum  
Stomach Clamp  
Forceps

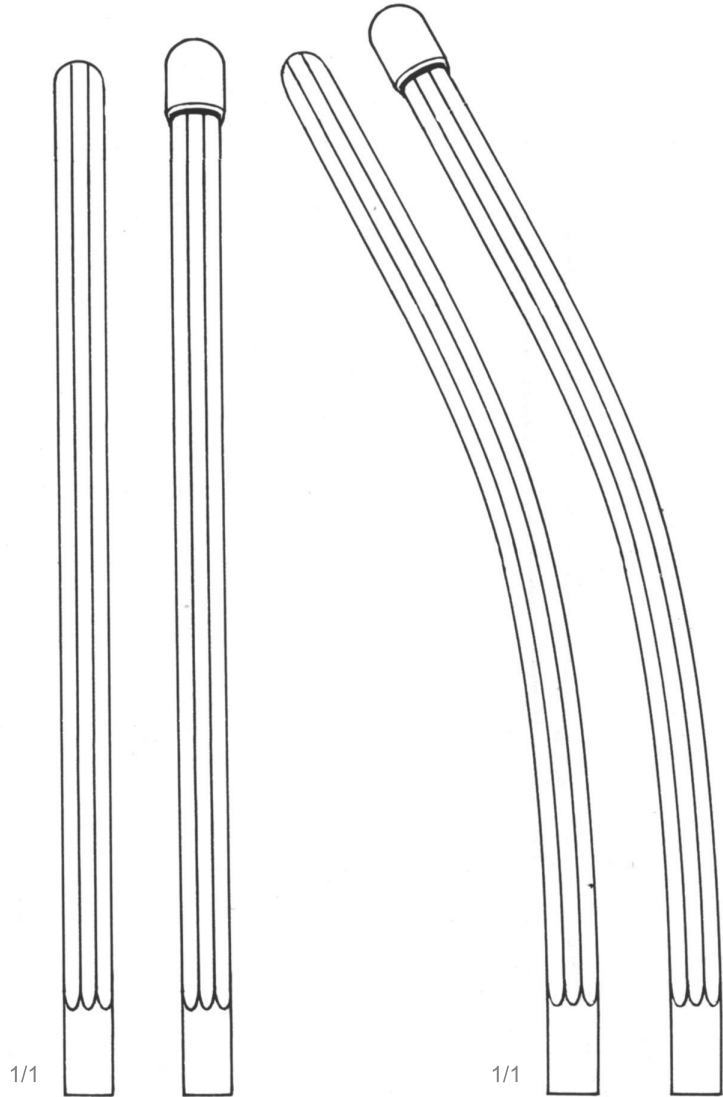

CK.464.30  
33,0 cm - 12"

CK.465.30  
33,0 cm - 12"

Stomach Clamp Forceps

MAGENKLEMMEN - PINZAS-CLAMPS ESTOMACALES

# Kolpen

INTESTINES, STOMACH, RECTUM  
DARM, MAGEN, MASTDARM  
INTESTINOS, ESTÓMAGOS, RECTO

**CK**



**CK.474.30**  
Lane  
Stomach Clamp  
Forceps

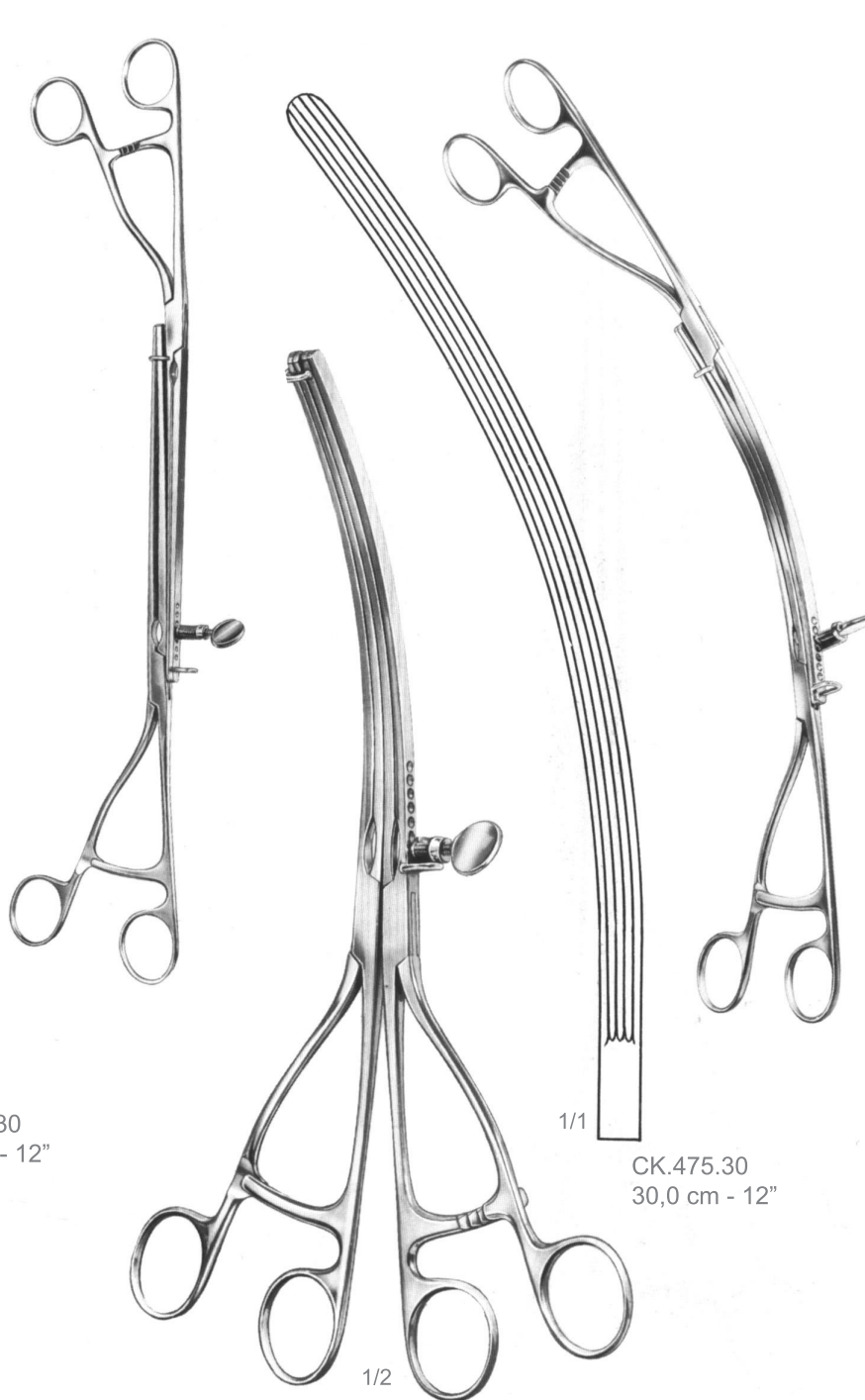

**CK.475.30**  
Lane  
Stomach Clamp  
Forceps

# Kolpen

INTESTINES, STOMACH, RECTUM  
DARM, MAGEN, MASTDARM  
INTESTINOS, ESTÓMAGOS, RECTO

## Intestinal and Stomach Clamps

DARM- UND MAGENKLEMMEN - PINZAS-CLAMPS INTESTINALES  
Y ESTOMACALES

CK

CK.478.36  
36,0 cm - 14"

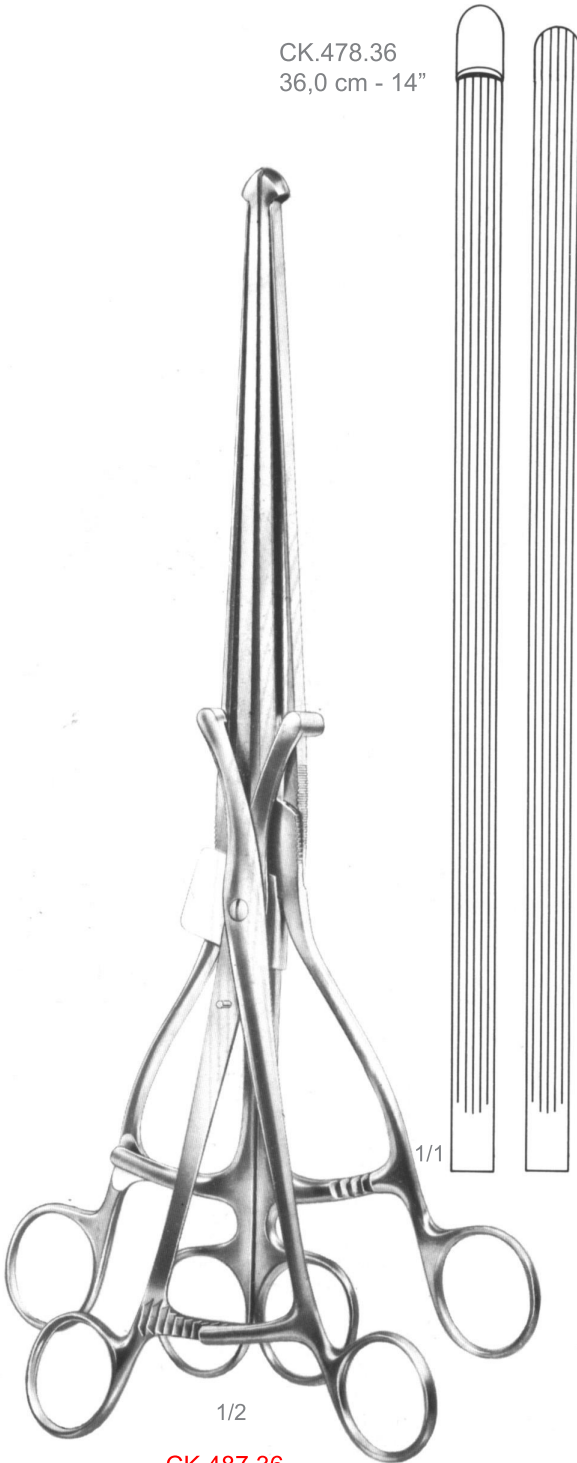

**CK.487.36**  
Haberer  
Intestinal and  
Stomach Clamps

CK.487.34  
34,0 cm - 13 1/2"

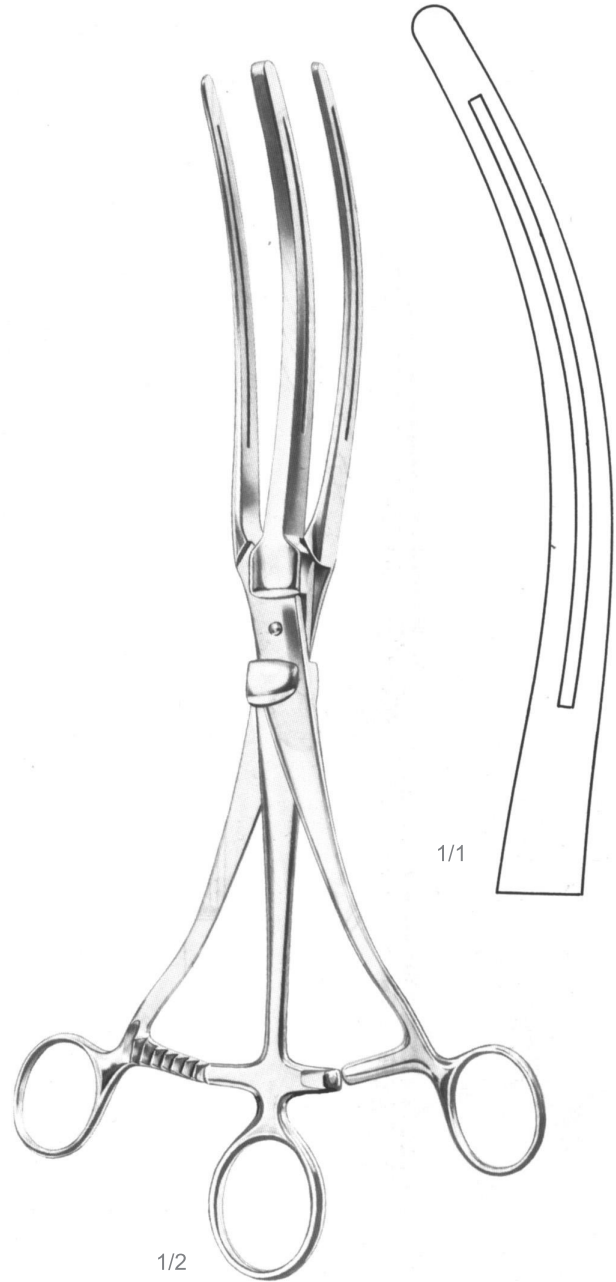

**CK.487.34**  
Roosevelt  
Intestinal and  
Stomach Clamps

# Intestinal and Anastomosis Clamps Forceps

DARMKLEMMEN, ANASTOMOSENKLEMMEN - PINZAS-CLAMPS INTESTINALES Y PARA ANASTOMOSIS

# Kolpen

INTESTINES, STOMACH, RECTUM  
DARM, MAGEN, MASTDARM  
INTESTINOS, ESTÓMAGOS, RECTO

**CK**

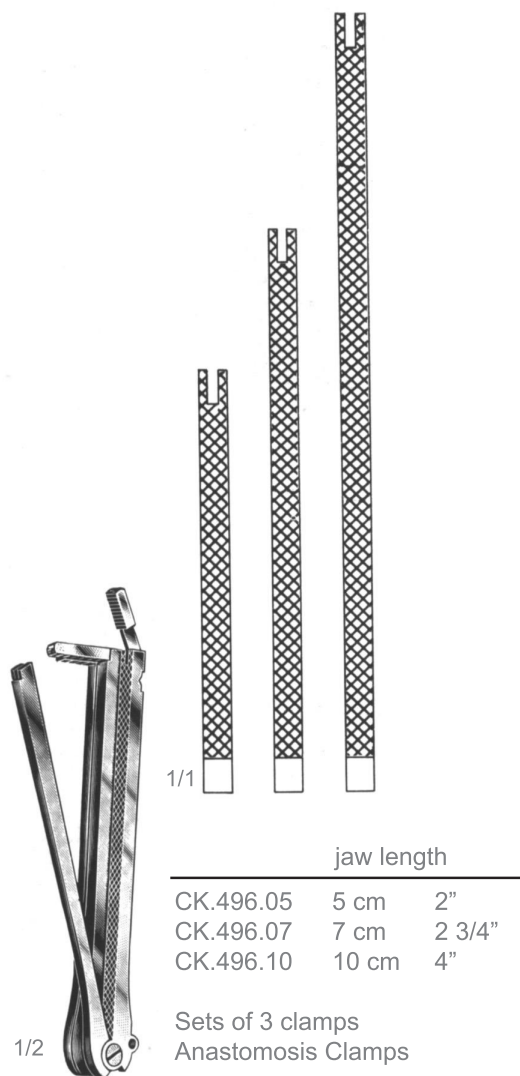

**CK.496.05/10**  
De Martel-Wolfson  
Intestinal and  
Anastomosis  
Clamps Forceps



**CK.497.26**  
De Martel-Wolfson  
Intestinal and  
Anastomosis  
Clamps Forceps



# Kolpen

INTESTINES, STOMACH, RECTUM  
DARM, MAGEN, MASTDARM  
INTESTINOS, ESTÓMAGOS, RECTO

## Intestinal and Anastomosis Clamps Forceps

DARMKLEMMEN, ANASTOMOSENKLEMMEN - PINZAS-CLAMPS INTESTINALES Y PARA ANASTOMOSIS

**CK**



- CK.498.08 -Clamp Holder, short
- CK.498.23 -Ditto, long
- CK.520.07/10 -Intestinal (Anastomosis) Clamps with locking ferrule
- CK.522.00 -Locking Ferrule only
- CK.524.15 -Clamp Holding and Closing Forceps

# Stomach and Intestinal Suturing Apparatus

MAGEN- UND DARM-NÄHAPPARAT - APARATO PARA SUTURAR ESTÓMAGO E INTESTINOS

# Kolpen

INTESTINES, STOMACH, RECTUM  
DARM, MAGEN, MASTDARM  
INTESTINOS, ESTÓMAGOS, RECTO

**CK**

CK.530.00  
Sterilizing Containers and Trays for sterile storage,  
see group 55.



**CK.530.00**  
v. Petz  
Stomach and  
Intestinal Suturing  
Apparatus

**CK.530.20**  
Stomach and  
Intestinal Suturing  
Apparatus

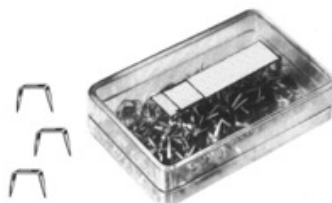

CK.530.20  
German Silver suturing  
clips package of 300 ea.

- CK.530.00 -Petz Stomach and Intestinal Suturing Apparatus, complete, for 23 pairs of suturing clips
- consisting of:
- CK.530.10 - Suturing apparatus
- CK.530.11 - Wooden case
- CK.530.12 - Additional closing clamp
- CK.530.13 - Gear wheel
- CK.530.14 - Filling rack
- CK.530.15 - Filling pin
- CK.604.10 - Filling tweezer
- CK.530.16 - Screw driver
- CK.530.17 - Metal box for clips
- CK.530.20 - Silver suturing clips, package of 300 ea.

CK.530.01 -Petz Stomach and Intestinal Suturing Apparatus, complete, without wooden case

# Kolpen

INTESTINES, STOMACH, RECTUM  
DARM, MAGEN, MASTDARM  
INTESTINOS, ESTÓMAGOS, RECTO

## Organ Grasping Forceps

ORGANFABZANGEN - PINZAS PARA COGER ÓRGANOS

CK



CK.540.18  
18,0 cm - 7"  
narrow



CK.540.20  
20,5 cm - 8"  
medium

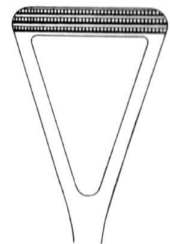

CK.540.23  
23,0 cm - 9"  
wide

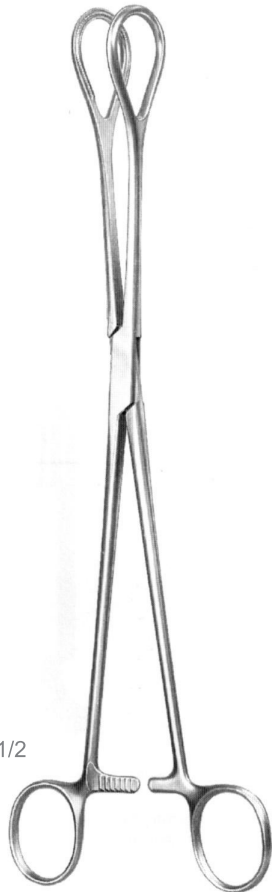

1/2

**CK.266.25/26**  
Organ Grasping  
Forceps



1/1

CK.266.25  
25,0 cm - 9 3/4"



CK.266.26  
26,0 cm - 10 1/4"



1/2

**CK.540.18/23**  
Scheibe  
Organ Grasping  
Forceps

## Atrauma Intestinal and Stomach Clamp Forceps, with Martin Serrations

ATRAUMA DARM- UND MAGENKLEMMEN MIT MARTIN-ZAHNUNG -  
ATRAUMA PINZAS-CLAMPS INTESTINALES Y ESTOMACALES CON DENTADO  
MARTIN

# Kolpen

INTESTINES, STOMACH, RECTUM  
DARM, MAGEN, MASTDARM  
INTESTINOS, ESTÓMAGOS, RECTO

CK



**CK.550.16/23**  
Doyen-Atrauma  
Atrauma Intestinal  
and Stomach Clamp  
Forceps

CK.550.16 16,0 cm - 6 1/2"  
CK.550.18 18,0 cm - 7"  
CK.550.21 21,0 cm - 8 1/2"  
CK.550.23 23,0 cm - 9"



**CK.551.16/23**  
Doyen-Atrauma  
Atrauma Intestinal  
and Stomach Clamp  
Forceps

CK.551.16 16,0 cm - 6 1/2"  
CK.551.18 18,0 cm - 7"  
CK.551.21 21,0 cm - 8 1/2"  
CK.551.23 23,0 cm - 9"

# Kolpen

INTESTINES, STOMACH, RECTUM  
DARM, MAGEN, MASTDARM  
INTESTINOS, ESTÓMAGOS, RECTO

## Atrauma Intestinal and Stomach Clamp Forceps, with Martin Serrations

ATRAUMA DARM- UND MAGENKLEMMEN MIT MARTIN-ZAHNUNG -  
ATRAUMA PINZAS-CLAMPS INTESITNALES Y ESTOMACALES CON DENTADO  
MARTIN

CK

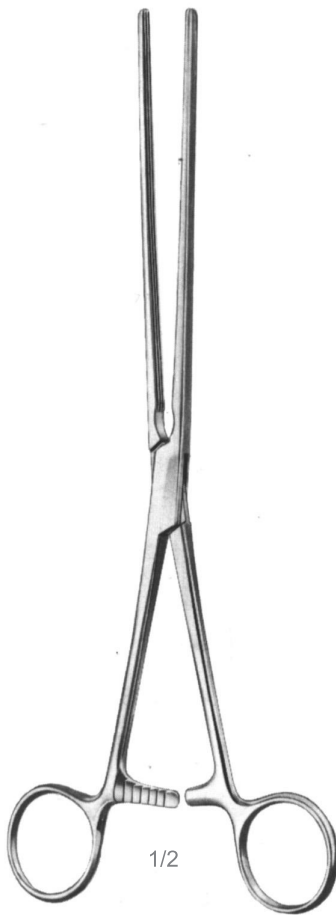

1/1  
CK.554.25  
25,0 cm - 10"

**CK.554.25**  
Mayo-Robson-Atrauma  
Atrauma Intestinal  
and Stomach Clamp  
Forceps

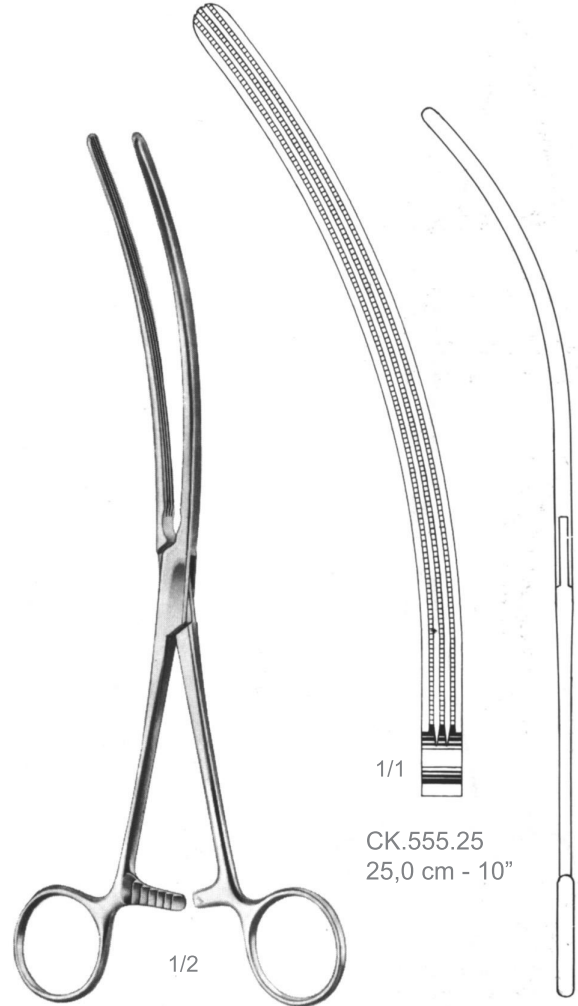

1/1  
CK.555.25  
25,0 cm - 10"

**CK.555.25**  
Mayo-Robson-Atrauma  
Atrauma Intestinal  
and Stomach Clamp  
Forceps

Atrauma Intestinal and Stomach Clamp Forceps, with Martin Serrations

ATRAUMA DARM- UND MAGENKLEMMEN MIT MARTIN-ZAHNUNG -  
 ATRAUMA PINZAS-CLAMPS INTESTINALES Y ESTOMACALES CON DENTADO  
 MARTIN

**Kolpen**

INTESTINES, STOMACH, RECTUM  
 DARM, MAGEN, MASTDARM  
 INTESTINOS, ESTÓMAGOS, RECTO

**CK**



**CK.560.22/28**  
 Kocher-Atrauma  
 Atrauma Intestinal  
 and Stomach Clamp  
 Forceps

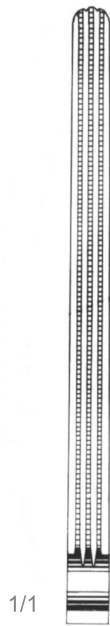

CK.560.22  
 22,0 cm - 8 3/4"

CK.560.25  
 25,0 cm - 10"

CK.560.28  
 28,0 cm - 11"

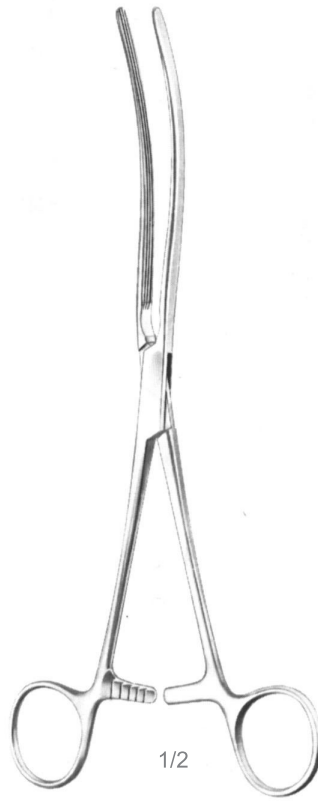

**CK.561.22/28**  
 Kocher-Atrauma  
 Atrauma Intestinal  
 and Stomach Clamp  
 Forceps

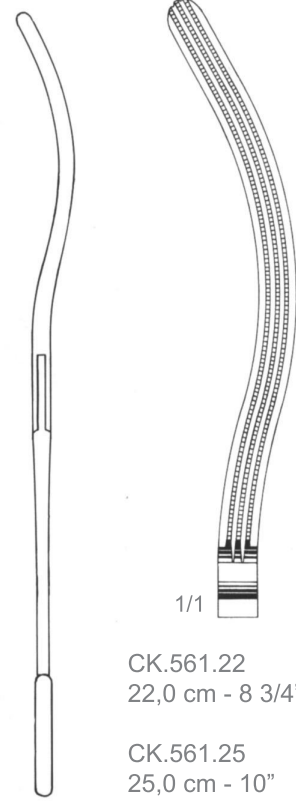

CK.561.22  
 22,0 cm - 8 3/4"

CK.561.25  
 25,0 cm - 10"

CK.561.28  
 28,0 cm - 11"

# Kolpen

INTESTINES, STOMACH, RECTUM  
DARM, MAGEN, MASTDARM  
INTESTINOS, ESTÓMAGOS, RECTO

## Atrauma Intestinal and Stomach Clamp Forceps, with Martin Serrations

ATRAUMA DARM- UND MAGENKLEMMEN MIT MARTIN-ZAHNUNG -  
ATRAUMA PINZAS-CLAMPS INTESITNALES Y ESTOMACALES CON DENTADO  
MARTIN

CK

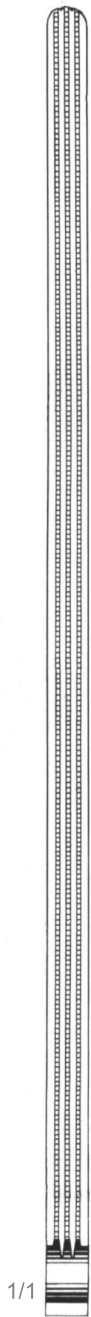

CK.570.33  
33,0 cm - 13"



**CK.570.33**  
**CK.571.33**  
Scudder-Atrauma  
Atrauma Intestinal  
and Stomach Clamp  
Forceps

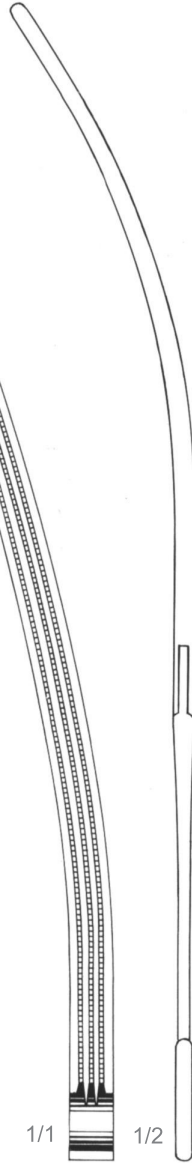

CK.571.33  
33,0 cm - 13"

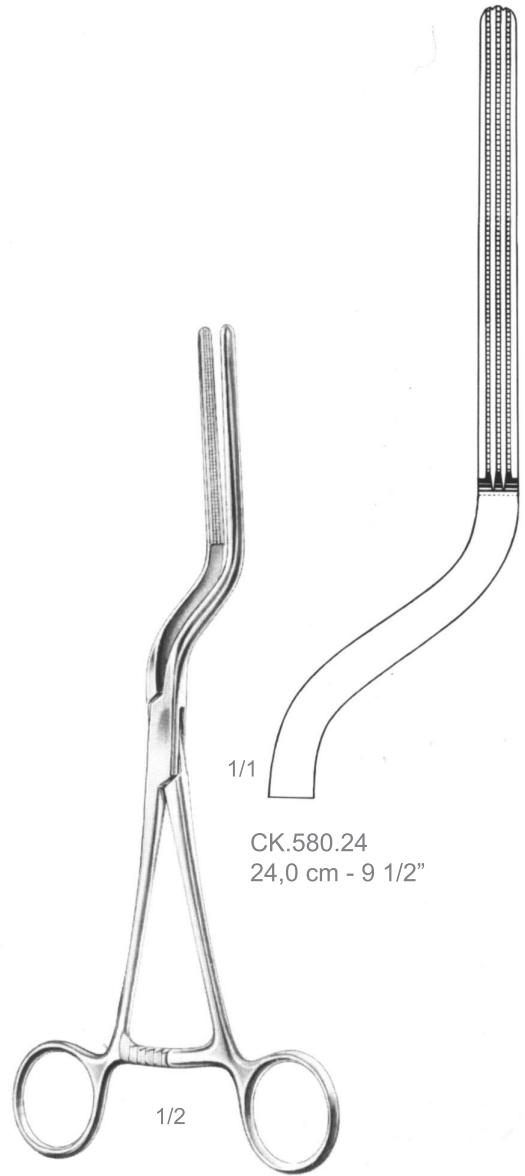

CK.580.24  
24,0 cm - 9 1/2"

**CK.580.24**  
Brunner  
Atrauma Intestinal  
and Stomach Clamp  
Forceps

# Atrauma Sigmoid Anastomosis Forceps

ATRAUMA REKTUM-ANASTOMOSENKLEMMEN -  
ATRAUMA PINZAS PARA ANASTOMOSIS DEL RECTO

# Kolpen

INTESTINES, STOMACH, RECTUM  
DARM, MAGEN, MASTDARM  
INTESTINOS, ESTÓMAGOS, RECTO

**CK**

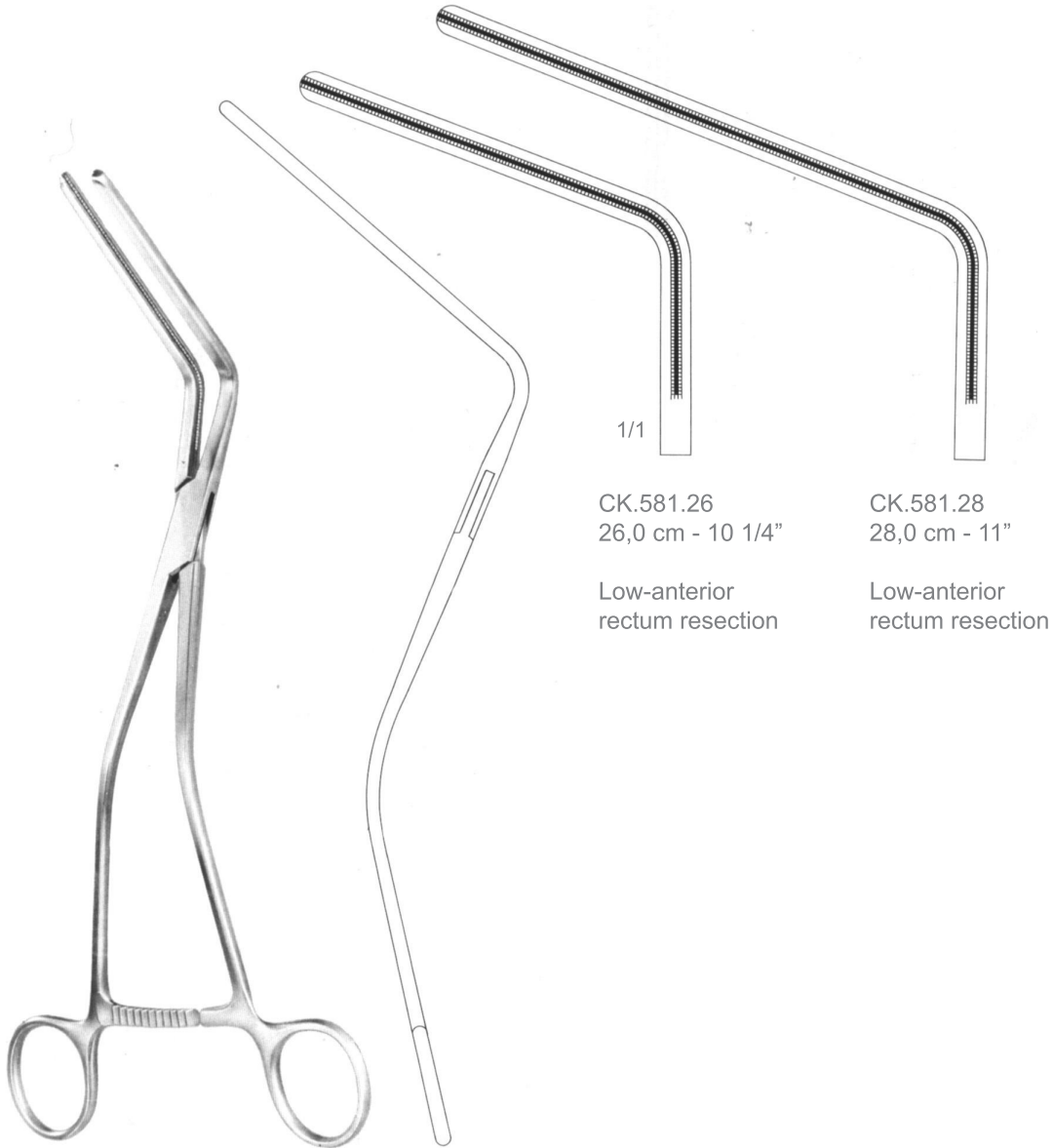

**CK.581.26/28**  
Hayes  
Atrauma Sigmoid  
Anastomosis Forceps

CK.581.26  
26,0 cm - 10 1/4"

Low-anterior  
rectum resection

CK.581.28  
28,0 cm - 11"

Low-anterior  
rectum resection



# Kolpen

INTESTINES, STOMACH, RECTUM  
DARM, MAGEN, MASTDARM  
INTESTINOS, ESTÓMAGOS, RECTO

## Atrauma Sigmoid Anastomosis Forceps

ATRAUMA REKTUM-ANASTOMOSENKLEMMEN -  
ATRUUMA PINZAS PARA ANASTOMOSIS DEL RECTO

CK

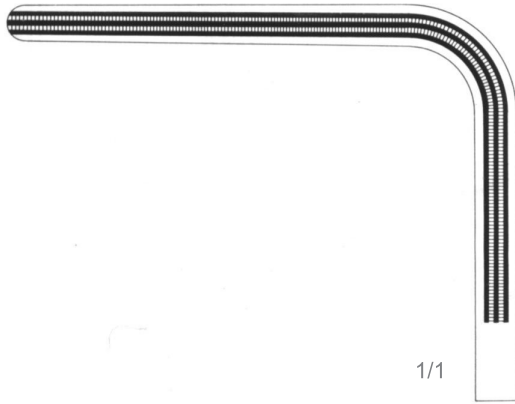

1/1



1/2

CK.583.23  
23,0 cm - 9"

**CK.583.23**  
Veidenheimer  
Atrauma Sigmoid  
Anastomosis Forceps

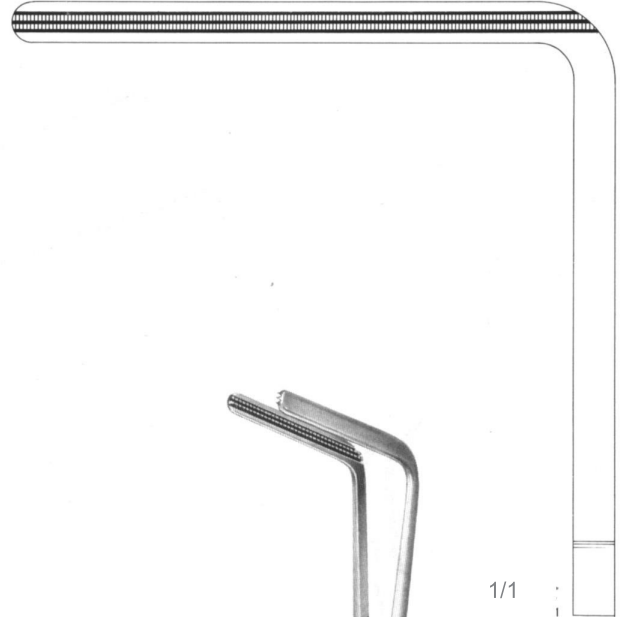

1/1



1/2

CK.585.24  
24,0 cm - 9 1/2"

**CK.585.24**  
Fehland  
Atrauma Sigmoid  
Anastomosis Forceps

## Atrauma Sigmoid Anastomosis Forceps

ATRAUMA REKTUM-ANASTOMOSENKLEMMEN -  
ATRAUMA PINZAS PARA ANASTOMOSIS DEL RECTO

# Kolpen

INTESTINES, STOMACH, RECTUM  
DARM, MAGEN, MASTDARM  
INTESTINOS, ESTÓMAGOS, RECTO

CK

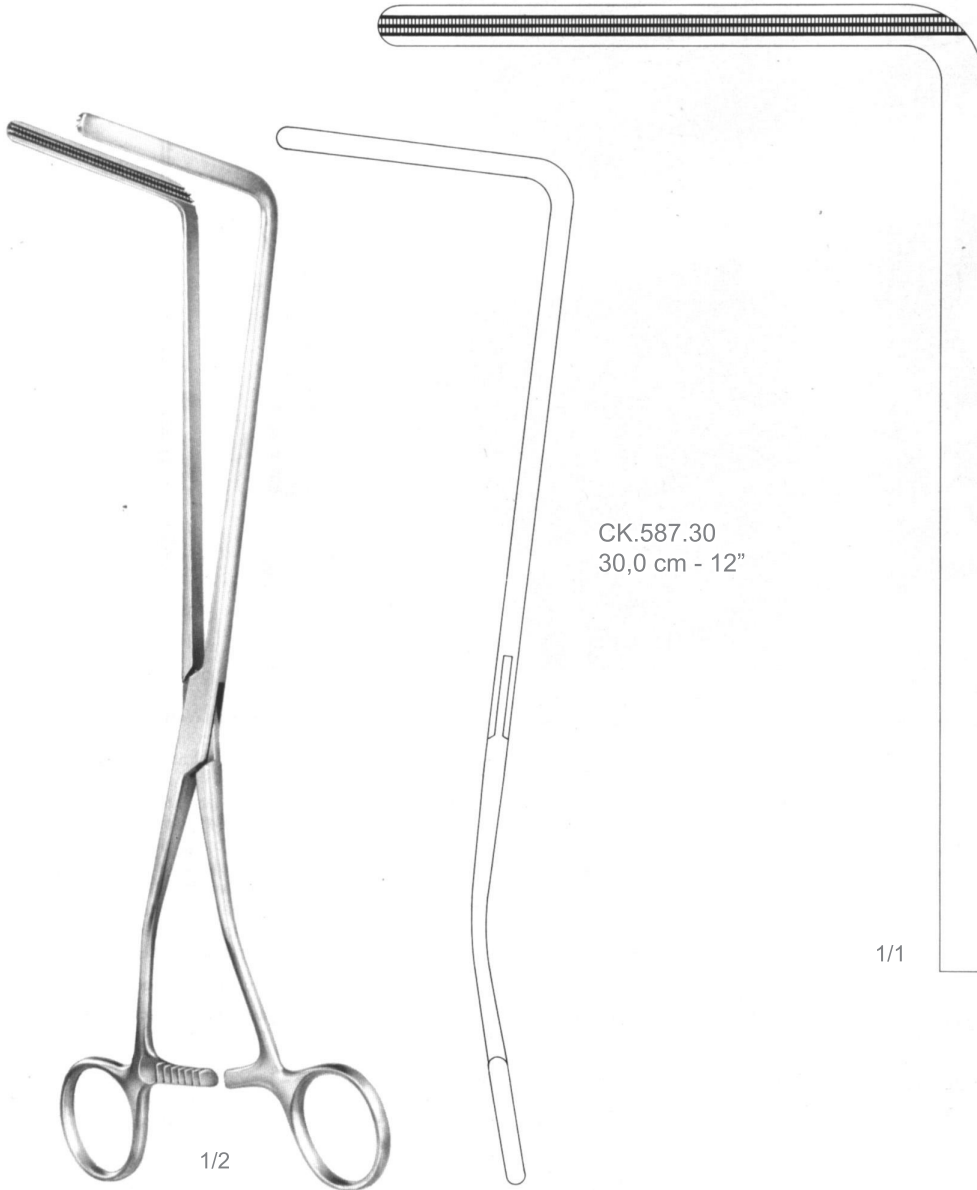

CK.587.30  
30,0 cm - 12"

**CK.587.30**  
Resano  
Atrauma Sigmoid  
Anastomosis Forceps

# Kolpen

INTESTINES, STOMACH, RECTUM  
DARM, MAGEN, MASTDARM  
INTESTINOS, ESTÓMAGOS, RECTO

## Rectoscope

REKTOSKOP - RECTOSCOPIO

**CK**

**CK.600.00**  
Strauss  
Rectoscope



**CK.602.00**  
Rectoscope

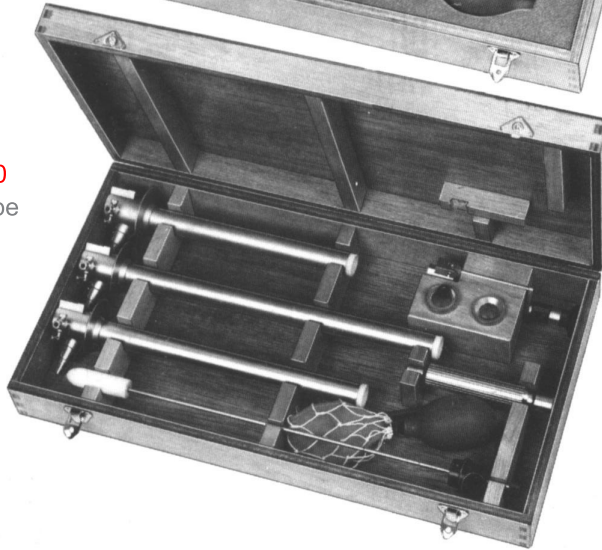

For use with transformer  
AG.878.01

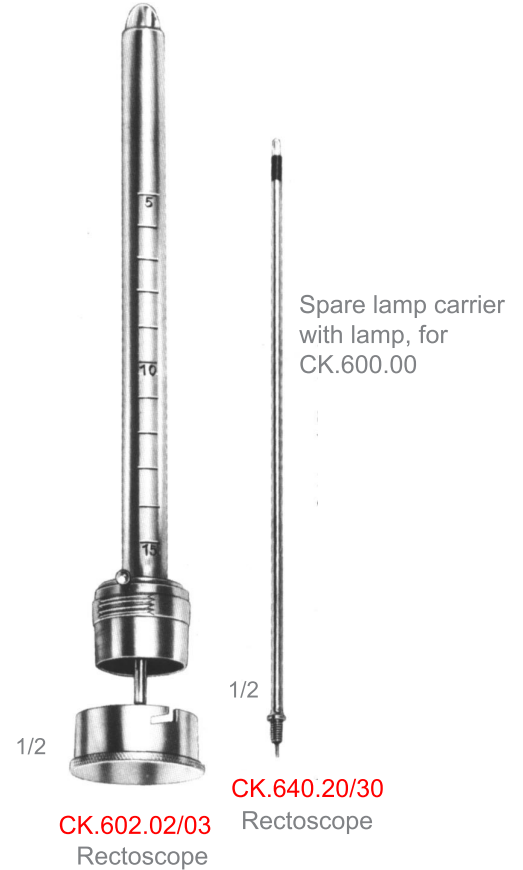

CK.600.00 -Rectoscope Set in wooden box, consisting of:  
3 graduated tubes, working length 20,25 and 30 cm,  
3 light carriers with lamps,  
1 adjustable obturator  
1 handle with switch  
1 adaptor with stopcock and window  
1 optical attachment acc. to Ringleb  
1 cord with plug  
1 rubber bulb  
3 spare bulbs

CK.600.01 Spare bulb, 4 volt, only

CK.600.02 Rectoscope Set, in wooden box, as CK.600.00 with additional pediatric tube 12 mm x 15 cm

CK.602.00 Rectoscope Set, cold light, in wooden box, consisting of:  
3 graduated tubes, working length 20,25 and 30 cm,  
3 cold light conductors  
1 adjustable obturator  
1 handle  
1 adaptor with stopcock and window  
1 optical attachment acc. to Ringleb  
1 rubber bulb

CK.602.02 Rectoscope Tube, Children's, working length 15 cm, Ø 12 mm, with obturator, light carrier and lamp

CK.602.03 Rectoscope Tube, Children's, Cold Light, working length 15 cm, Ø 12 mm, with obturator and fiber glass light conductor

# Rectal Specula

MASTDARM-SPEKULA - ESPÉCULOS RECTALES

# Kolpen

INTESTINES, STOMACH, RECTUM  
DARM, MAGEN, MASTDARM  
INTESTINOS, ESTÓMAGOS, RECTO

**CK**

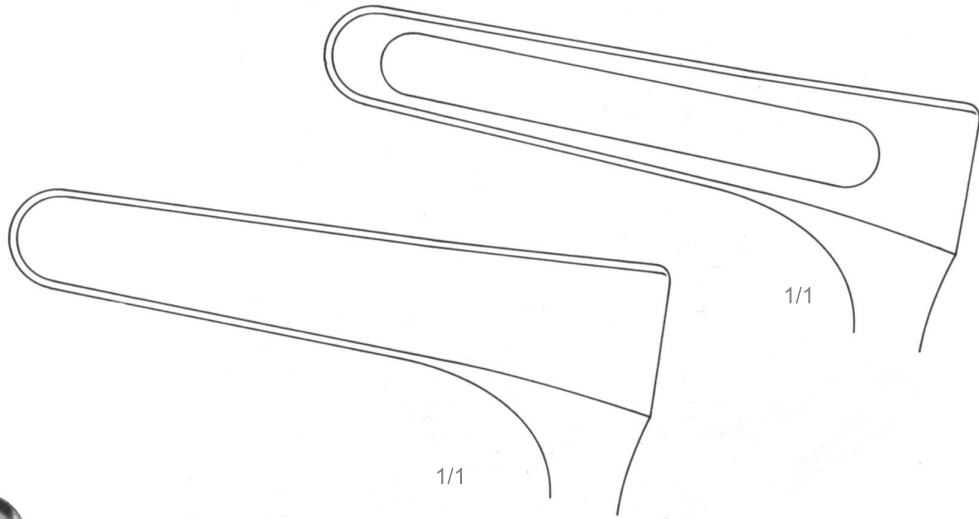

CK.605.21  
22,0 cm - 8 3/4"

1/2

**CK.605.21**  
Czerny  
Rectal Specula



CK.613.15  
15,0 cm - 6"

1/2

**CK.613.15**  
Sims  
Rectal Specula

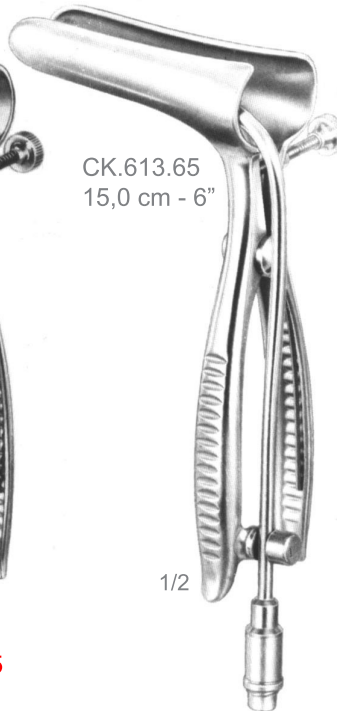

CK.613.65  
15,0 cm - 6"

1/2

**CK.613.65**  
Sims  
Rectal Specula



CK.615.15  
15,0 cm - 6"

1/2

**CK.615.15**  
Sims  
Rectal Specula

CK.613.65  
CK.613.66

-with interchangeable fiber optic light carrier  
-Fiber optic light carrier for CK.613.65

# Kolpen

INTESTINES, STOMACH, RECTUM  
DARM, MAGEN, MASTDARM  
INTESTINOS, ESTÓMAGOS, RECTO

## Rectal Specula

MASTDARM-SPEKULA - ESPÉCULOS RECTALES

CK

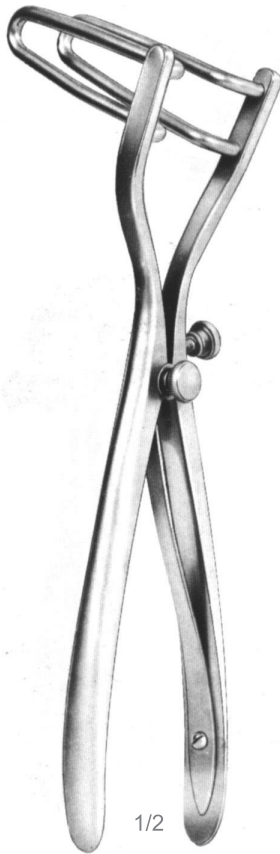

**CK.621.06/12**  
Schulze-Bergmann  
Rectal Specula

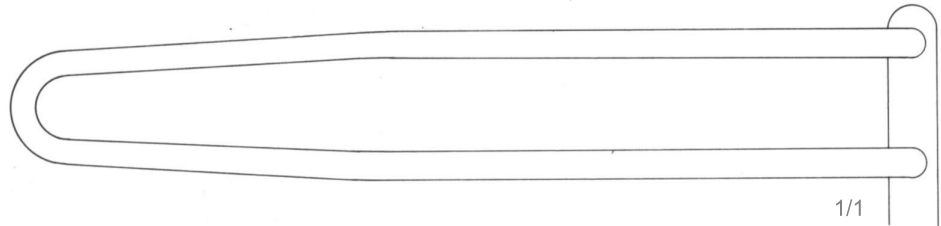

CK.621.12  
22,0 cm - 8 1/2"  
Length of Blades 125 mm

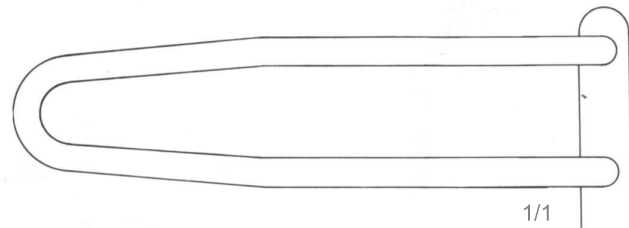

CK.621.08  
22,0 cm - 8 1/2"  
Length of Blades 80 mm

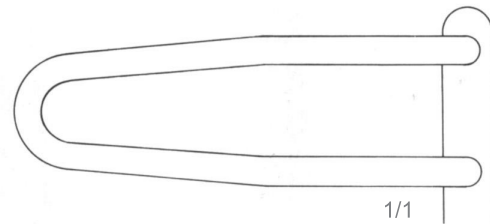

CK.621.06  
22,0 cm - 8 1/2"  
Length of Blades 60 mm

## Rectal Specula

MASTDARM-SPEKULA - ESPÉCULOS RECTALES

# Kolpen

INTESTINES, STOMACH, RECTUM  
DARM, MAGEN, MASTDARM  
INTESTINOS, ESTÓMAGOS, RECTO

CK

CK.625.19  
19,5 cm - 7 3/4"

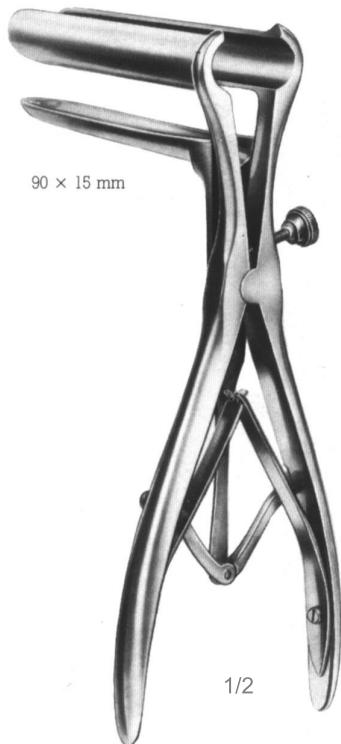

**CK.625.19**  
Mathieu  
Rectal Specula

CK.631.19  
19,0 cm - 7 1/2"

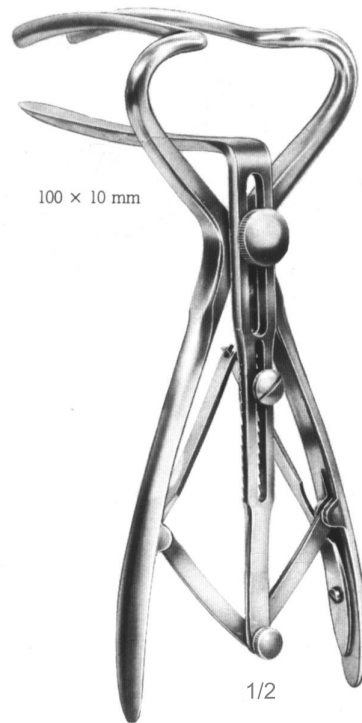

**CK.631.19**  
Cook  
Rectal Specula

CK.641.15  
15,0 cm - 6"

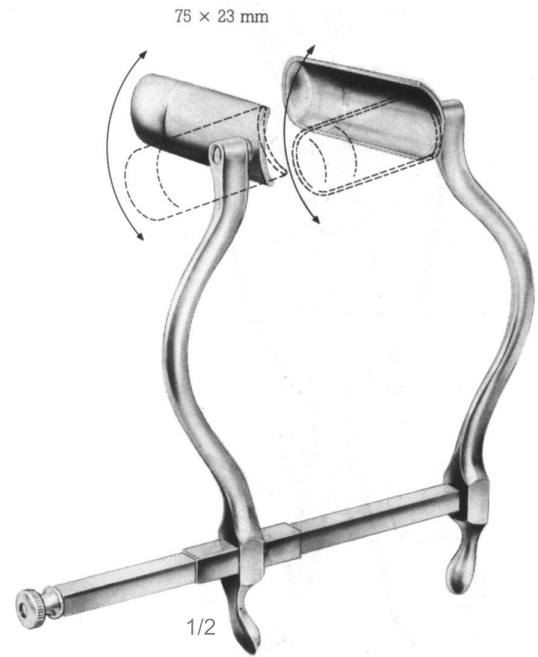

**CK.641.15**  
Smith-Buie  
Rectal Specula

CK

CK.645.17  
17,0 cm - 6 3/4"



**CK.645.17**  
Barr  
Rectal Specula,  
Anal Retractor

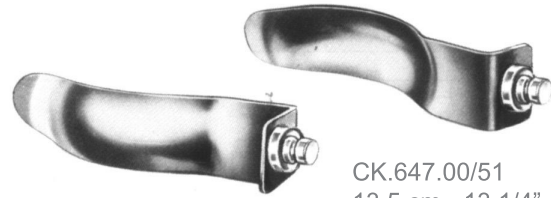

CK.647.00/51  
13,5 cm - 13 1/4"  
with 2 pair of blades and  
eenter blades

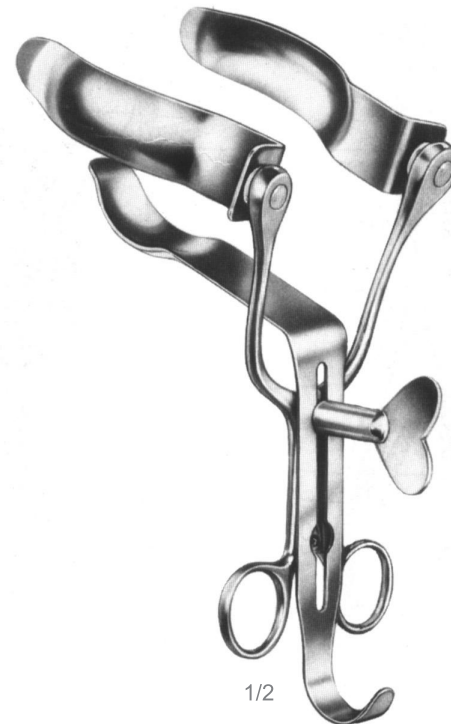

**CK.647.00/51**  
Alan Parks  
Rectal Specula,  
Anal Retractor

CK.647.50 -centre valve with interchangeable fiber optic light carrier  
CK.647.51 -fiber optic light carrier for CK.647.50



Rectal Specula, Anal Retractors, Anoscope

MASTDARM-SPEKULA, -PREIZER, ANUSKOP -  
 ESPÉCULOS RECTALES, ANASCOPIO

# Kolpen

INTESTINES, STOMACH, RECTUM  
 DARM, MAGEN, MASTDARM  
 INTESTINOS, ESTÓMAGOS, RECTO



**CK.651.15**  
 Ives-Fansler  
 Rectal Specula,  
 Anal Retractors,  
 Anoscope

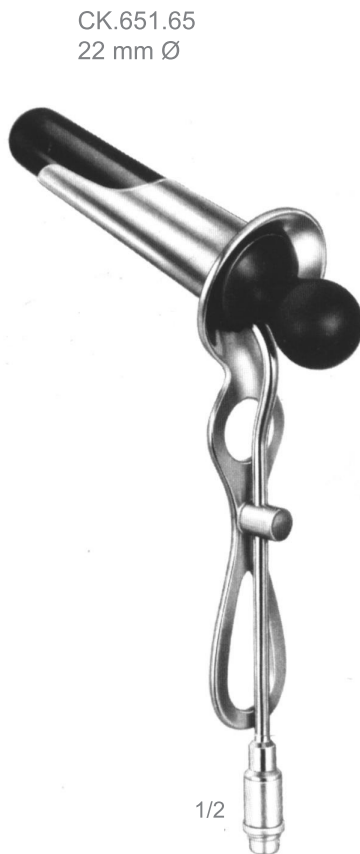

**CK.651.65**  
 Ives-Fansler  
 Rectal Specula,  
 Anal Retractors,  
 Anoscope

- CK.655.01 16 mm Ø x 65 mm
- CK.655.02 19 mm Ø x 65 mm
- CK.655.03 22 mm Ø x 65 mm

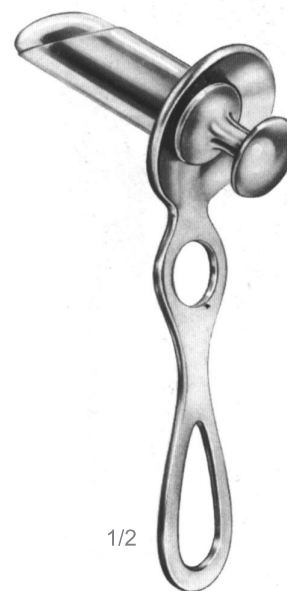

**CK.655.01/03**  
 Hirschmann  
 Rectal Specula,  
 Anal Retractors,  
 Anoscope

CK.651.65  
 CK.651.66

-with vulcanite obturator and interchangeable  
 fiber optic light carrier  
 -fiber optic light carrier for CK.651.65



# Kolpen

INTESTINES, STOMACH, RECTUM  
DARM, MAGEN, MASTDARM  
INTESTINOS, ESTÓMAGOS, RECTO

## Sphincteroscopes, Anoscopes, Proctoscopes

SPHINKTEROSKOPE, ANUSKOPE, PROKTOSKOPE -  
ESFINTEROSCOPIOS, ANOSCOPIOS, PROCTOSCOPIOS

CK



1/2

CK.669.01 16 mm Ø x 63 mm  
CK.669.02 19 mm Ø x 63 mm  
CK.669.03 23 mm Ø x 63 mm

**CK.669.01/03**  
Newman  
Sphincteroscopes,  
Anoscopes,  
Proctoscopes



1/2

**CK.679.01/02**  
Kelly  
Sphincteroscopes,  
Anoscopes,  
Proctoscopes

CK.679.01 21 mm Ø x 50 mm  
CK.679.02 27 mm Ø x 50 mm

CK.669.01 / CX.675.04  
CK.679.01 / CX.679.02



1/2

**CK.675.01/03**  
Kelly  
Sphincteroscopes,  
Anoscopes,  
Proctoscopes

CK.675.01 22 mm Ø x 50 mm  
CK.675.02 22 mm Ø x 100 mm  
CK.675.03 22 mm Ø x 140 mm

-Proctoscopes, with obturators  
-Sphincteroscopes, with obturators

# Rectal Biopsy Specimen Forceps

MASTDARM-BIOPSIENZANGE · PINZA SACABOCADO PARA BIOPSIA RECTAL

# Kolpen

INTESTINES, STOMACH, RECTUM  
DARM, MAGEN, MASTDARM  
INTESTINOS, ESTÓMAGOS, RECTO

**CK**

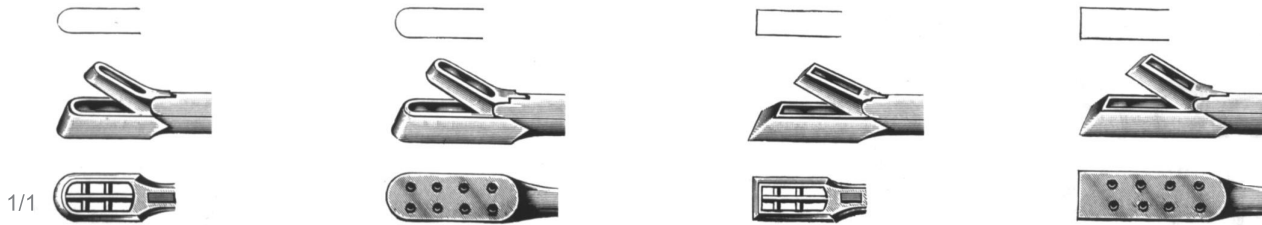
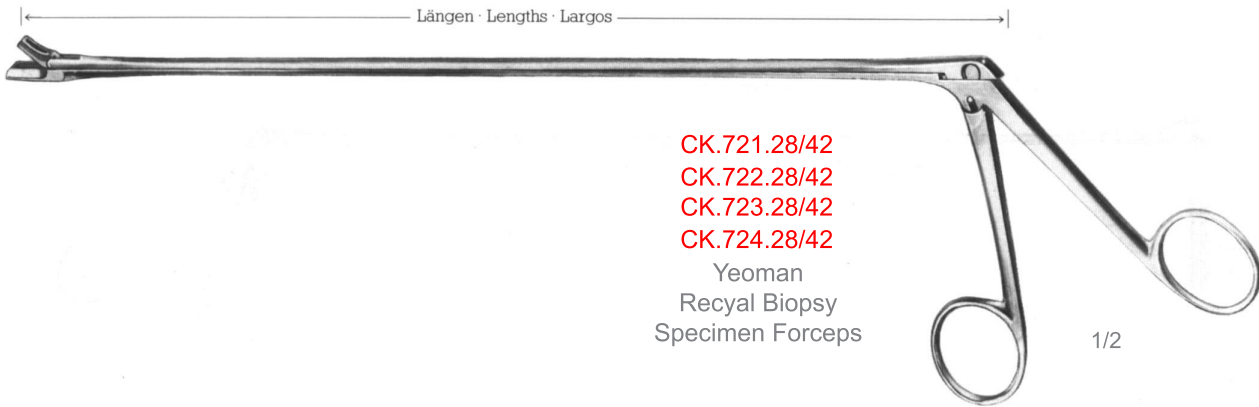

CK.721.28	28,0 cm - 11"	CK.722.28	28,0 cm - 11"	CK.723.28	28,0 cm - 11"	CK.724.28	28,0 cm - 11"
CK.721.35	35,0 cm - 13 3/4"	CK.722.35	35,0 cm - 13 3/4"	CK.723.35	35,0 cm - 13 3/4"	CK.724.35	35,0 cm - 13 3/4"
CK.721.42	42,0 cm - 16 1/2"	CK.722.42	42,0 cm - 16 1/2"	CK.723.42	42,0 cm - 16 1/2"	CK.724.42	42,0 cm - 16 1/2"

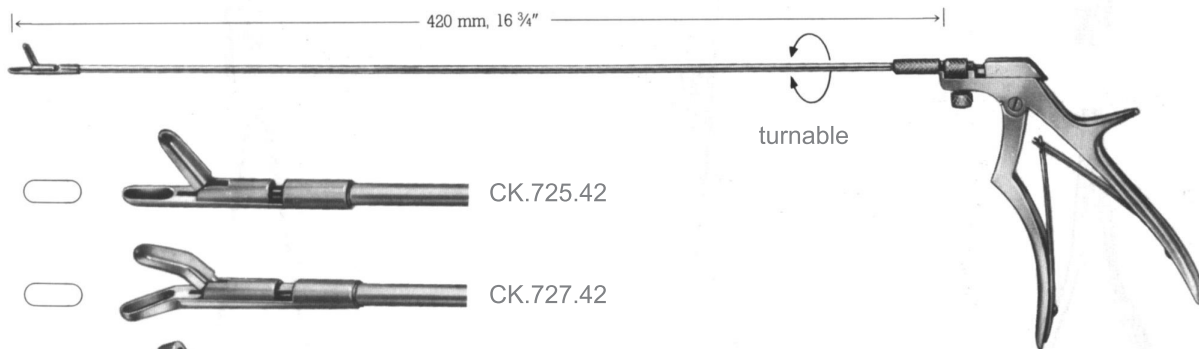

CK.725.42

CK.727.42

CK.729.42

CK.731.42

CK.733.42

1/1

**CK.725.00**  
Recyal Biopsy  
Specimen Forceps

CK.725.00  
Handle only

# Kolpen

INTESTINES, STOMACH, RECTUM  
DARM, MAGEN, MASTDARM  
INTESTINOS, ESTÓMAGOS, RECTO

## Rectal Biopsy Specimen Forceps, Haemorrhoidal (Pile) Forceps

MASTDARM-BIOPSIEZANGE, HÄMORRHOIDALZANGEN -  
PINZA SACABOCADO PARA BIOPSIA RECTAL,  
PINZAS-CLAMPS HEMORROIDALES

**CK**

CK.723.26  
Loading Cone



1/2

**CK.723.26**  
Rud  
Rectal Biopsy  
Specimen Forceps,  
Haemorrhoidal  
Forceps

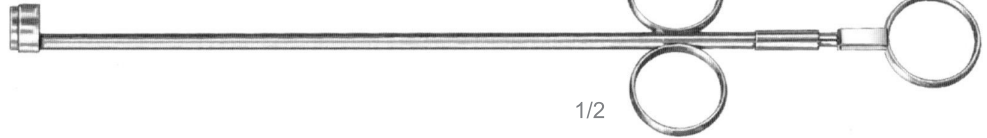

1/2

**CK.723.27**  
Rud  
Rectal Biopsy Specimen Forceps,  
Haemorrhoidal Forceps

CK.723.10  
Rubber Rings

1/2 

**CK.723.10**  
Rectal Biopsy  
Specimen Forceps,  
Haemorrhoidal  
Forceps

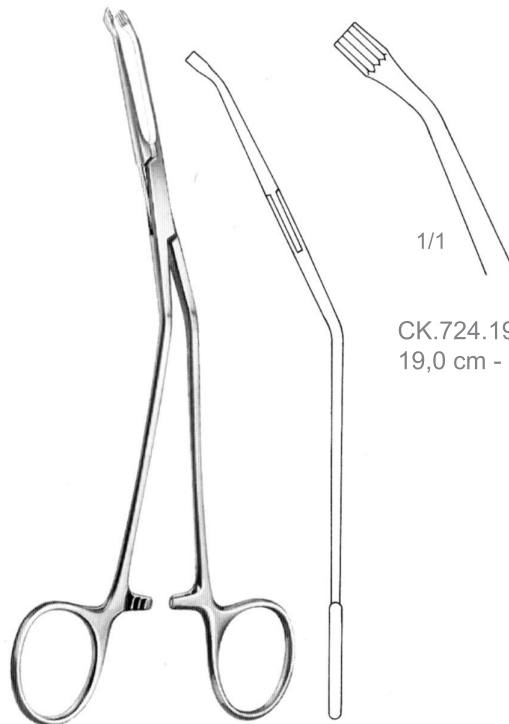

1/1

CK.724.19  
19,0 cm - 7 1/2"

1/2

**CK.724.19**  
McGinvey  
Rectal Biopsy Specimen Forceps,  
Haemorrhoidal Forceps

Rectal Biopsy Specimen Forceps, Haemorrhoidal (Pile) Forceps

MASTDARM-BIOPSIEZANGE, HÄMORRHOIDALZANGEN -  
 PINZA SACABOCADO PARA BIOPSIA RECTAL,  
 PINZAS-CLAMPS HEMORROIDALES

# Kolpen

INTESTINES, STOMACH, RECTUM  
 DARM, MAGEN, MASTDARM  
 INTESTINOS, ESTÓMAGOS, RECTO

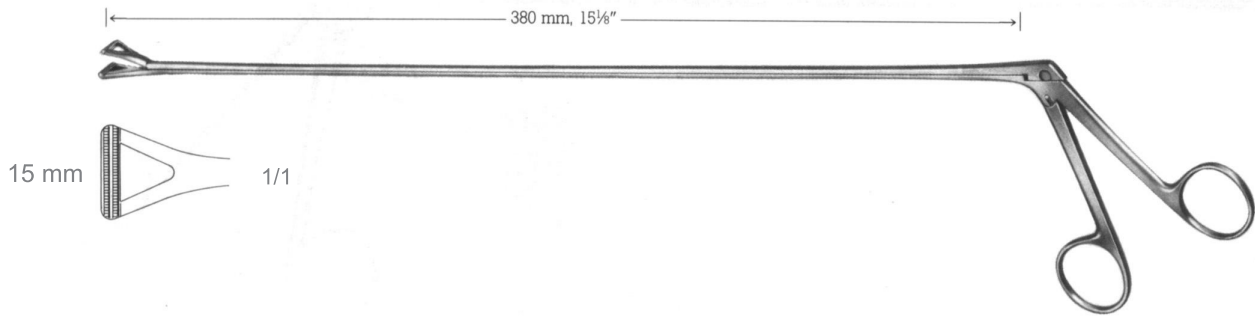

**CK.741.38**

Rectal Biopsy Specimen Forceps,  
 Haemorrhoidal Forceps



CK.750.24  
 24,5 cm - 9 3/4"

**CK.750.24**

Luer  
 Rectal Biopsy  
 Specimen Forceps,  
 Haemorrhoidal  
 Forceps

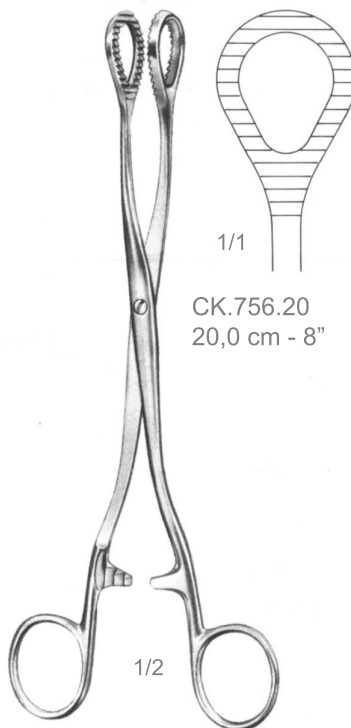

CK.756.20  
 20,0 cm - 8"

**CK.756.20**

Heywood-Smith  
 Rectal Biopsy  
 Specimen Forceps,  
 Haemorrhoidal  
 Forceps

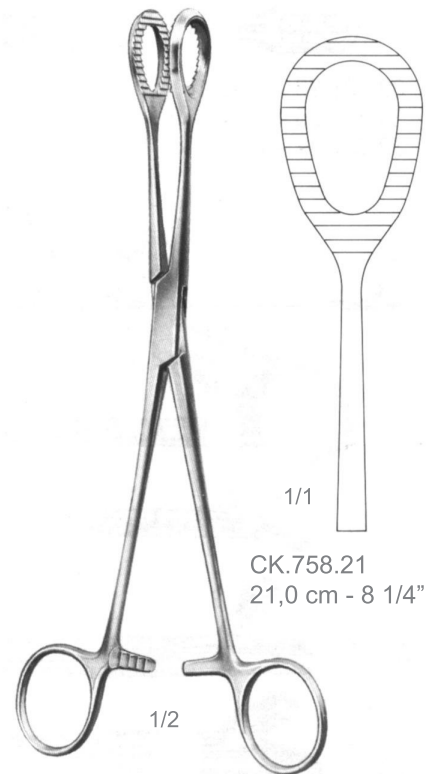

CK.758.21  
 21,0 cm - 8 1/4"

**CK.758.21**

Heywood-Smith  
 Rectal Biopsy  
 Specimen Forceps,  
 Haemorrhoidal  
 Forceps