

Kolpen

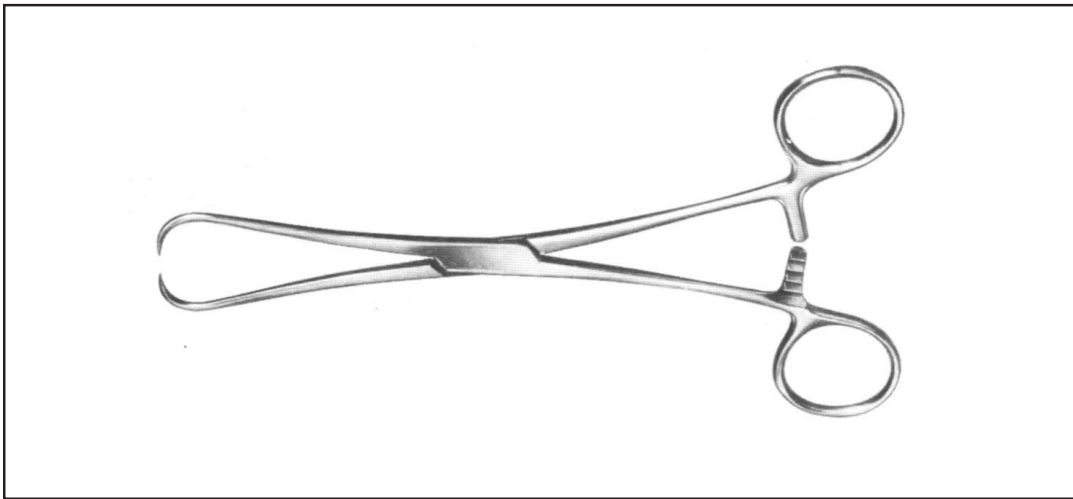

С В

Kolpen

Vaginal Specula

GYNECOLOGY
GYNÄKOLOGIE
GINECOLOGÍA

SCHEIDENSPEKULA - ESPÉCULOS VAGINALES

CB

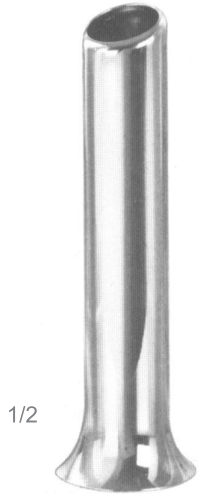

CB.102.01/03
Fergusson
Vaginal Specula

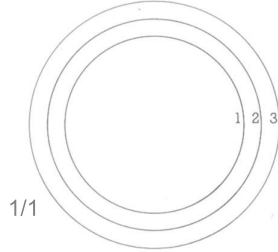

CB.102.01 25 mm Ø
CB.102.02 30 mm Ø
CB.102.03 35 mm Ø

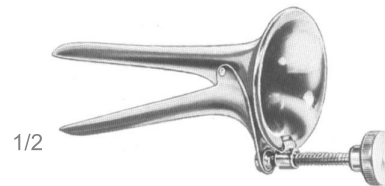

CB.106.01
Collin
Vaginal Specula

CB.106.01
55 x 10 mm
for children

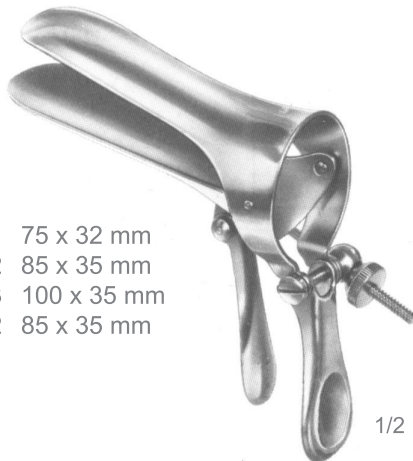

CB.110.01 75 x 32 mm
CB.110.02 85 x 35 mm
CB.110.03 100 x 35 mm
CB.110.52 85 x 35 mm

CB.110.01/52
CUSCO
Vaginal Specula



CB.112.01 75 x 17 mm

CB.112.01
CUSCO
Vaginal Specula

CB.102.01 - CB.102.01
CB.110.01 - CB.110.03
CB.110.52
CB.110.53
CB.112.01

- Metal Specula, tubular shape
- Vaginal Specula with lateral ratchet, with folding handles
- with interchangeable fiber optic light carrier
- fiber optic light carrier for CB.110.52
- ditto, conical shape, virgin size

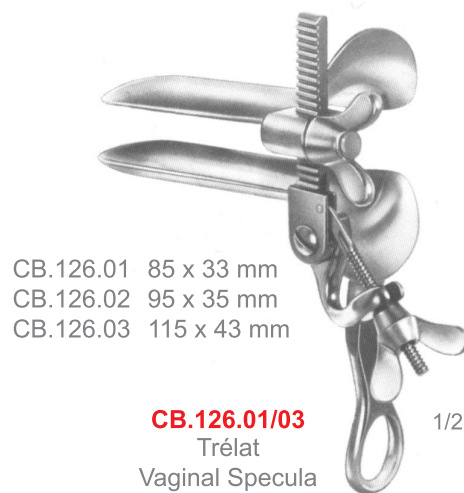
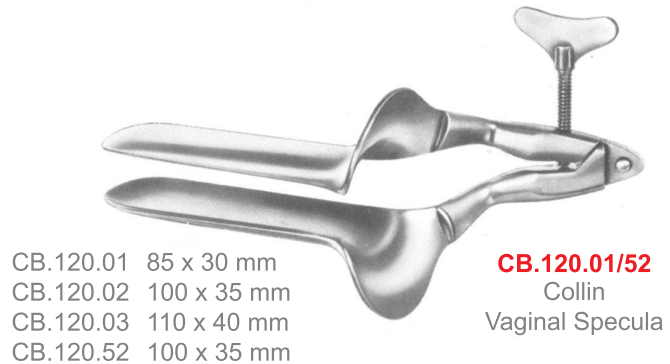
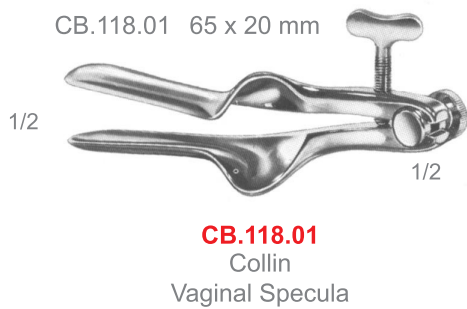

- CB.114.01 - CB.114.03
- CB.116.01 - CB.116.03
- CB.120.01 - CB.120.03
- CB.120.52
- CB.120.53
- CB.122.02
- CB.126.01 - CB.126.03

- Swiss pattern narrow, with lateral ratchet, with folding handles
- with ratchet at the folding handles
- detachable
- with interchangeable fiber optic light carrier
- fiber optic light carrier for CB.120.52
- detachable, top blade shorter
- detachable, with folding handles

CB

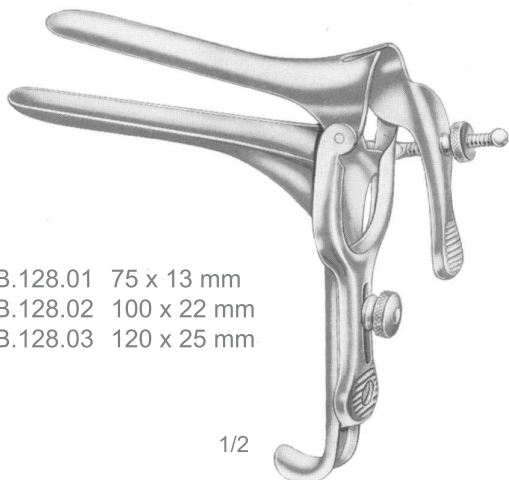

CB.128.01 75 x 13 mm
CB.128.02 100 x 22 mm
CB.128.03 120 x 25 mm

1/2

CB.128.01/03
Pederson
Vaginal Specula

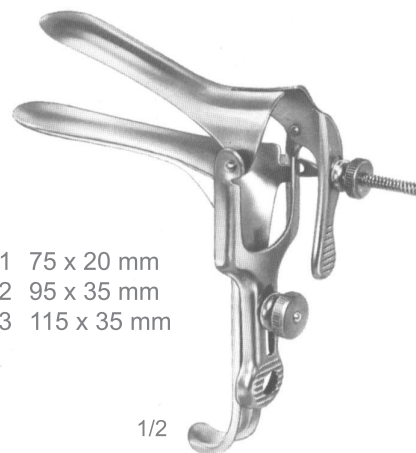

CB.130.01 75 x 20 mm
CB.130.02 95 x 35 mm
CB.130.03 115 x 35 mm

1/2

CB.130.01/03
Grave
Vaginal Specula

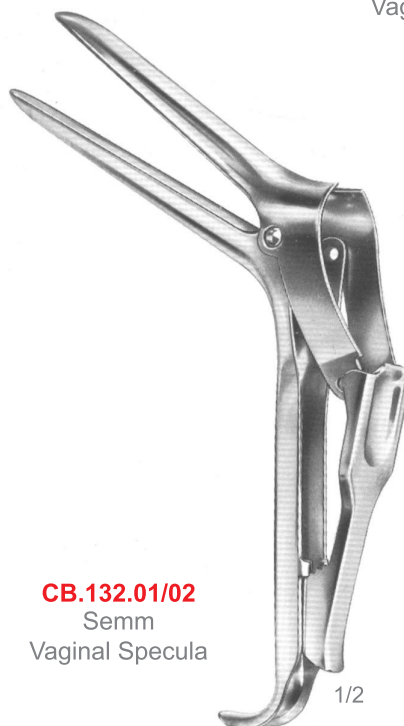

CB.132.01/02
Semm
Vaginal Specula

1/2

CB.132.01 100 x 17/20 mm
CB.132.02 100 x 25/30 mm

CB.130.01 - CB.130.03

- with lateral ratchet, detachable, lower blade convertible
into vaginal retractor

CB.132.01 - CB.132.02

- for one handed use

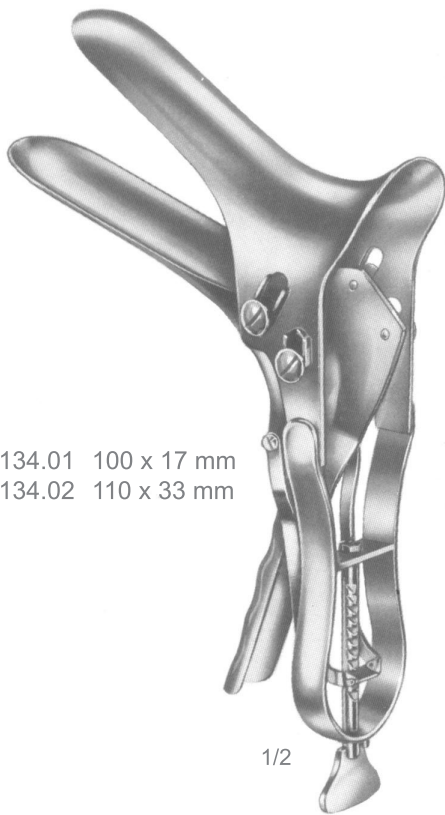

CB.134.01 100 x 17 mm
CB.134.02 110 x 33 mm

1/2

CB.134.01/02
Seyffert
Vaginal Specula

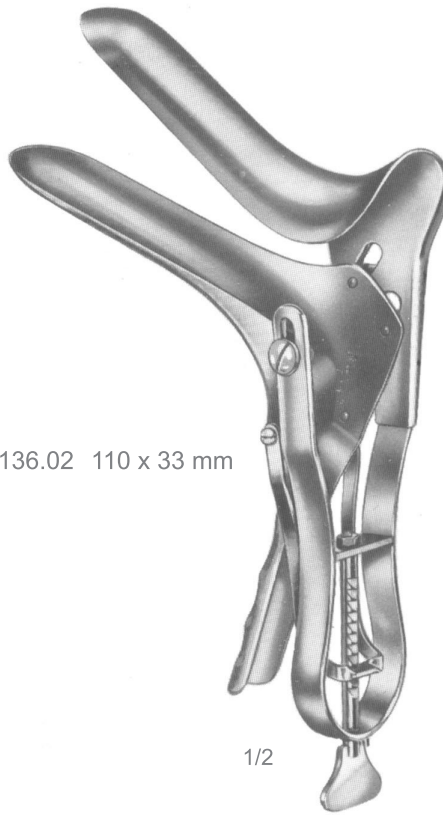

CB.136.02 110 x 33 mm

1/2

CB.136.02
Seyffert
Vaginal Specula

CB

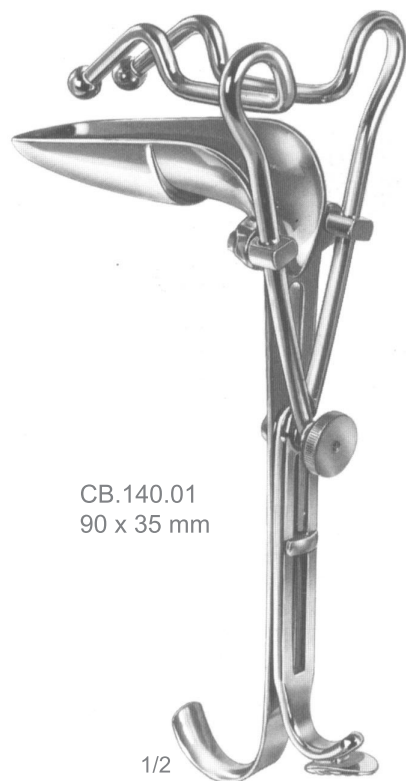

CB.140.01
90 x 35 mm

CB.140.01
Guttman
Vaginal Specula

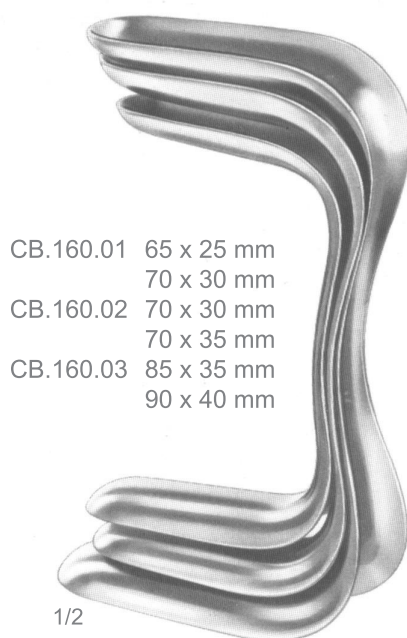

CB.160.01 65 x 25 mm
70 x 30 mm
CB.160.02 70 x 30 mm
70 x 35 mm
CB.160.03 85 x 35 mm
90 x 40 mm

CB.160.01/03
Sims
Vaginal Specula

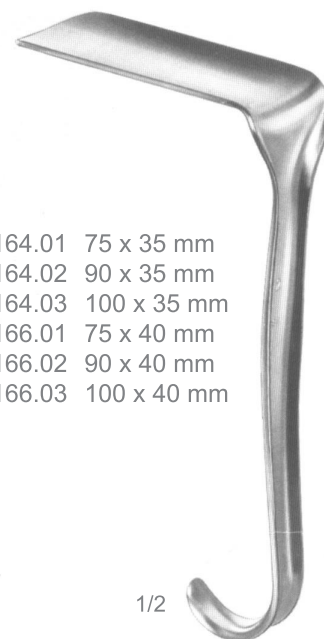

CB.164.01 75 x 35 mm
CB.164.02 90 x 35 mm
CB.164.03 100 x 35 mm
CB.166.01 75 x 40 mm
CB.166.02 90 x 40 mm
CB.166.03 100 x 40 mm

CB.164.01/03
CB.166.01/03
Jackson
Vaginal Specula

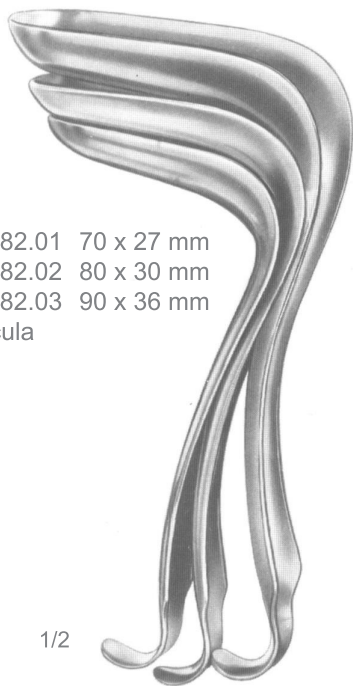

CB.182.01 70 x 27 mm
CB.182.02 80 x 30 mm
CB.182.03 90 x 36 mm
Specula

CB.182.01/03
Kristeller
Vaginal Specula



CB.183.01 75 x 23 mm
CB.183.02 85 x 26 mm
CB.183.03 100 x 32 mm
Retractors

CB.183.01/03
Kristeller
Vaginal Specula

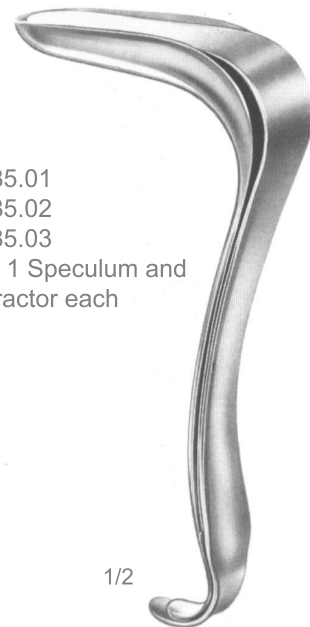

CB.185.01
CB.185.02
CB.185.03
Set of 1 Speculum and
1 Retractor each

CB.185.01/03
Kristeller
Vaginal Specula

CB



CB.190.01 105 x 18 mm
CB.190.02 105 x 21 mm
Specula

CB.190.01/02
Kristeller
Vaginal Specula

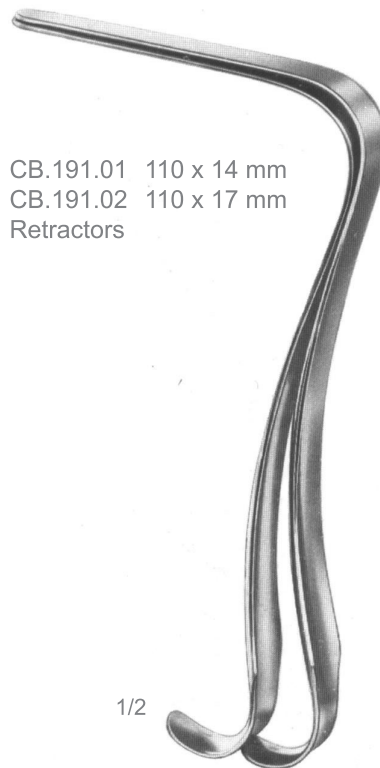

CB.191.01 110 x 14 mm
CB.191.02 110 x 17 mm
Retractors

CB.191.01/02
Kristeller
Vaginal Specula



CB.195.01
CB.195.02
Set of 1 Speculum and
1 Retractor each

CB.195.01/02
Kristeller
Vaginal Specula

Vaginal Specula and Retractor

SCHEIDENSPEKULA UND -HALTER - ESPÉCULOS Y VALVAS VAGINALES

Kolpen

GYNECOLOGY
GYNÄKOLOGIE
GINECOLOGÍA

CB



Specula flat hollow

CB.196.01 105 x 20 mm
CB.196.02 105 x 28 mm
CB.196.03 105 x 33 mm
Specula

CB.197.01 115 x 22 mm
CB.197.02 115 x 24 mm
CB.197.03 115 x 29 mm
Retractors

CB.199.01
CB.199.02
Set of 1 Speculum and
1 Retractor each



1/2

CB.196.01/03
Vaginal Specula and
Retractors



1/2

CB.197.01/03
Kristeller
Vaginal Specula and
Retractors



1/2

CB.199.01/03
Kristeller
Vaginal Specula and
Retractors

CB



Specula deep hollow

CB.202.01 110 x 27 mm
CB.202.02 110 x 30 mm
CB.202.03 110 x 36 mm
Specula

CB.203.01 115 x 23 mm
CB.203.02 115 x 26 mm
CB.203.03 115 x 32 mm
Retractors

CB.205.01
CB.205.02
CB.205.03
Set of 1 Speculum and
1 Retractor each



1/2

CB.202.01/03
Kristeller
Vaginal Specula and
Retractors



1/2

CB.203.01/03
Kristeller
Vaginal Specula and
Retractors



1/2

CB.205.01/03
Kristeller
Vaginal Specula and
Retractors



extra large pattern

1/2

CB.206.03
140 x 30 mm

CB.207.03
135 x 36 mm

CB.209.03

CB.206.03
CB.207.03
CB.209.03

Vaginal Specula and
Retractors

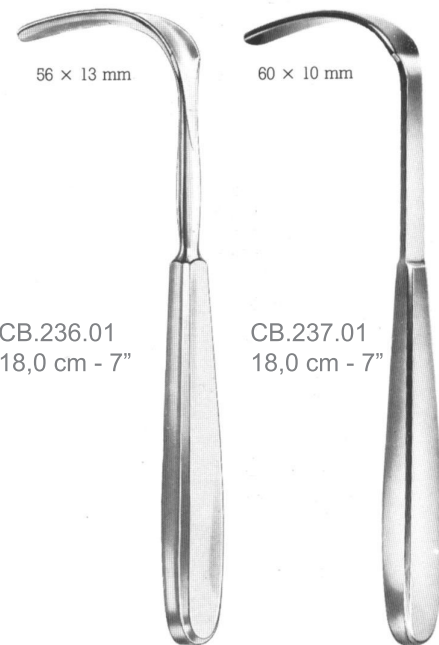

56 x 13 mm

60 x 10 mm

CB.236.01
18,0 cm - 7"

CB.237.01
18,0 cm - 7"

CB.236.01
Braun
Vaginal Specula and
Retractors

CB.237.01
Braun
Vaginal Specula and
Retractors

CB

CB.233.01 70 x 33 mm
CB.233.02 90 x 33 mm
Vaginal Retractors

CB.243.01 100 x 11 mm
100 x 20 mm
CB.243.02 100 x 14 mm
100 x 26 mm
Vaginal Retractors

CB.232.01 70 x 40 mm
CB.232.02 90 x 40 mm
Vaginal Specula

CB.242.01 95 x 16 mm
95 x 26 mm
CB.242.02 95 x 16 mm
95 x 30 mm
Vaginal Specula

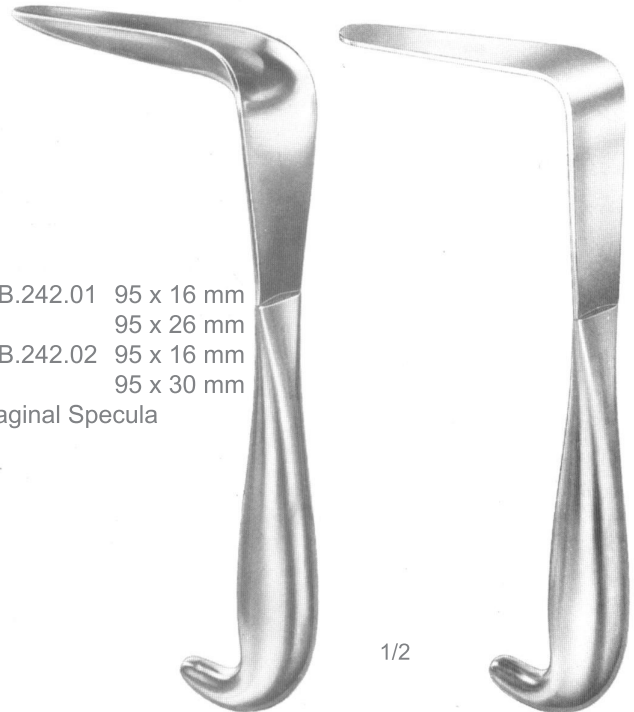

CB.232.01/02
Kallmorgen
Vaginal Specula and
Retractors

CB.233.01/02
Kallmorgen
Vaginal Specula and
Retractors

CB.242.01/02
Mathieu
Vaginal Specula and
Retractors

CB.243.01/02
Mathieu
Vaginal Specula and
Retractors

CB.235.01
CB.235.02
Set

CB.245.01
CB.245.02
Set

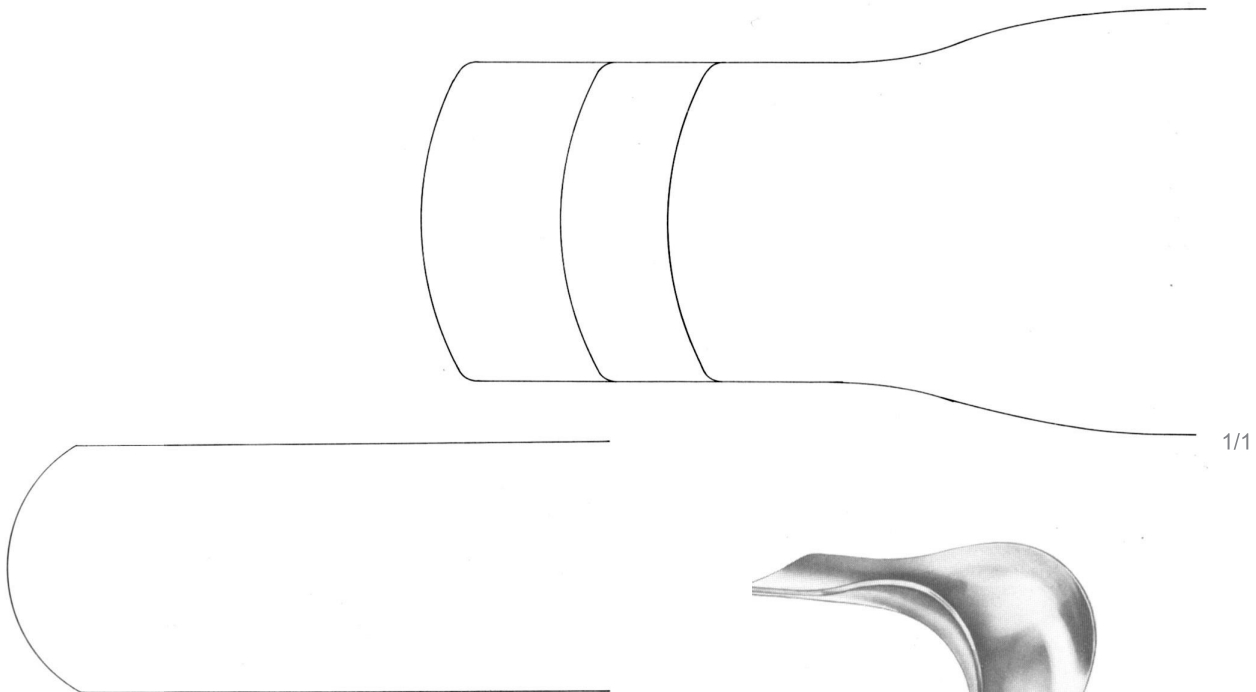

slightly- concave	a mm	b mm
CB.249.01	55	35
CB.249.02	58	35
CB.249.03	115	35
CB.250.01	55	45
CB.250.02	85	45
CB.250.03	115	45
CB.250.04	160	45
CB.251.01	55	60
CB.251.02	85	60
CB.251.03	115	60
CB.251.04	160	60

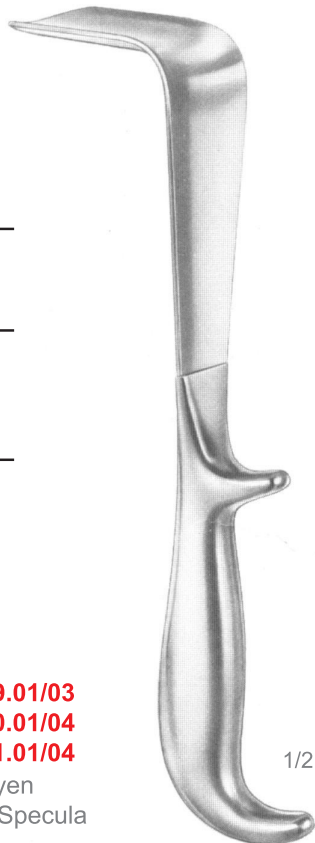

CB.249.01/03
CB.250.01/04
CB.251.01/04
Doyen
Vaginal Specula

	a mm	b mm
CB.280.01	75	45
CB.280.02	90	45
CB.280.03	110	45

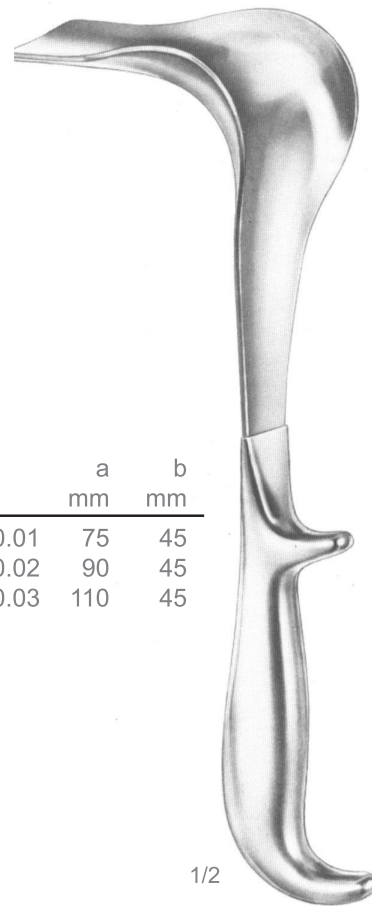

CB.280.01/03
Doyen
Vaginal Specula

Kolpen

Vaginal Specula

GYNECOLOGY
GYNÄKOLOGIE
GINECOLOGÍA

SCHEIDENSPEKULA - ESPÉCULOS VAGINALES

CB

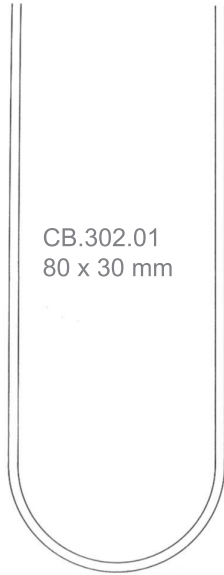

CB.302.01
80 x 30 mm



CB.302.02
85 x 35 mm

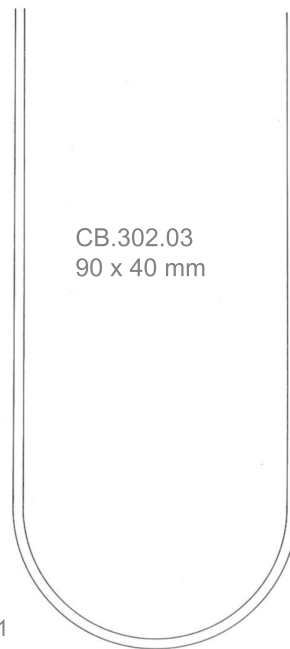

CB.302.03
90 x 40 mm

1/1



CB.302.01/03
Vaginal Specula

1/2

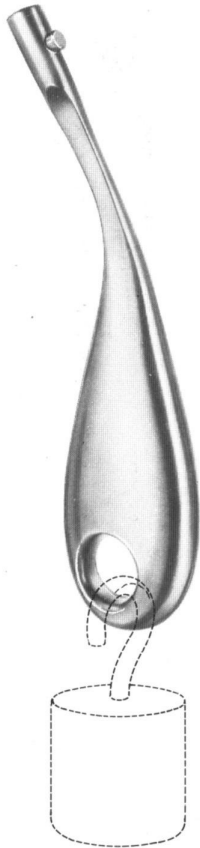

CB.302.00
Scherbak
Vaginal Specula

1/2

CB.302.10
Weight, light,
400 grs

CB.302.12
Weight, heavy,
800 grs



CB.302.10/12
Scherbak
Vaginal Specula



CB.302.04
55 x 40/60 mm

1/1

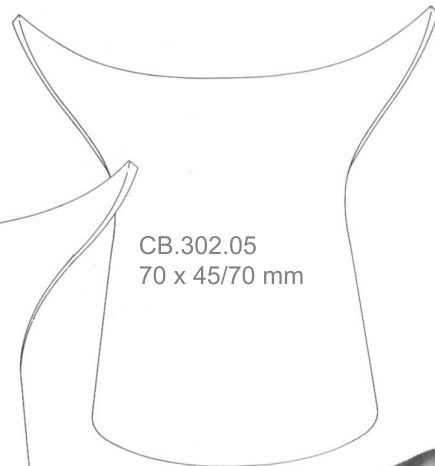

CB.302.05
70 x 45/70 mm



CB.302.04/05
Vaginal Specula

1/2

CB.302.00

CB.302.01 - CB.302.05

CB.302.10

CB.302.12

CB.302.14

- Set consisting of handle, weight,
and 5 blades

- Blades only

- Weight only, 400 grs.

- ditto, heavy, 800 grs.

- Handle only

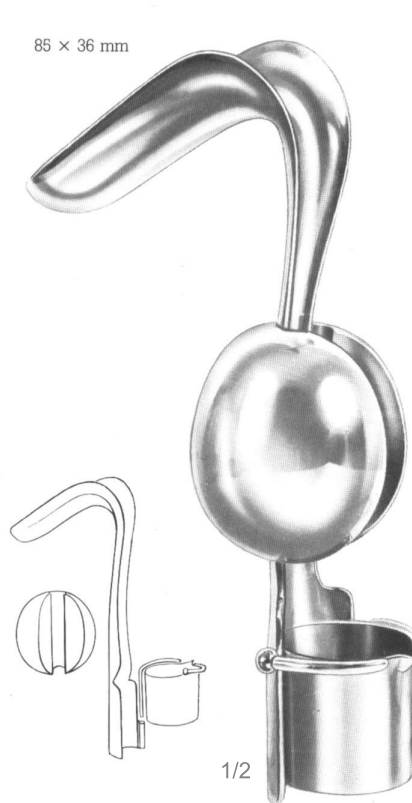

CB.306.00/01
Samuel
Vaginal Specula



CB.310.22
Auvard
Vaginal Specula



CB.314.24
Weissbarth
Vaginal Specula

CB.306.00 - complete, with removable weight and metal strainer with perforated bottom for retaining specimen

CB.306.01 - Metal Strainer with perforated bottom only

CB.310.22 - complete, with removable weight

CB.314.24 - complete, with removable strainer with perforated bottom

Kolpen

GYNECOLOGY
GYNÄKOLOGIE
GINECOLOGÍA

Vaginal Specula and Retractor

SCHEIDENSPEKULA UND -HALTER - ESPÉCULOS Y VALVAS VAGINALES

CB

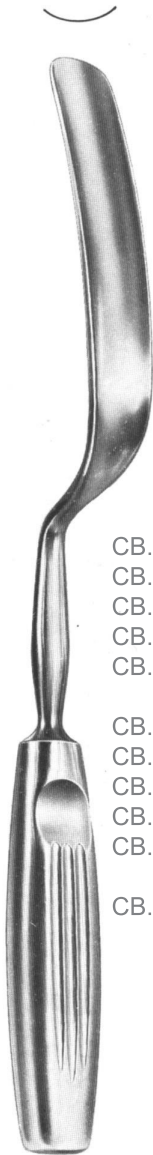

- CB.223.20 100 x 20 mm
- CB.223.25 100 x 25 mm
- CB.223.30 100 x 30 mm
- CB.223.35 100 x 35 mm
- CB.223.40 100 x 40 mm

- CB.224.20 130 x 20 mm
- CB.224.25 130 x 25 mm
- CB.224.30 130 x 30 mm
- CB.224.35 130 x 35 mm
- CB.224.40 130 x 40 mm

- CB.225.40 155 x 40 mm

CB.223.20/40
CB.224.20/40
CB.225.40
Breisky
Vaginal Specula and
Retractors



- CB.226.01 105 x 28 mm
- CB.226.02 105 x 38 mm

CB.226.01/02
Landau
Vaginal Specula and
Retractors

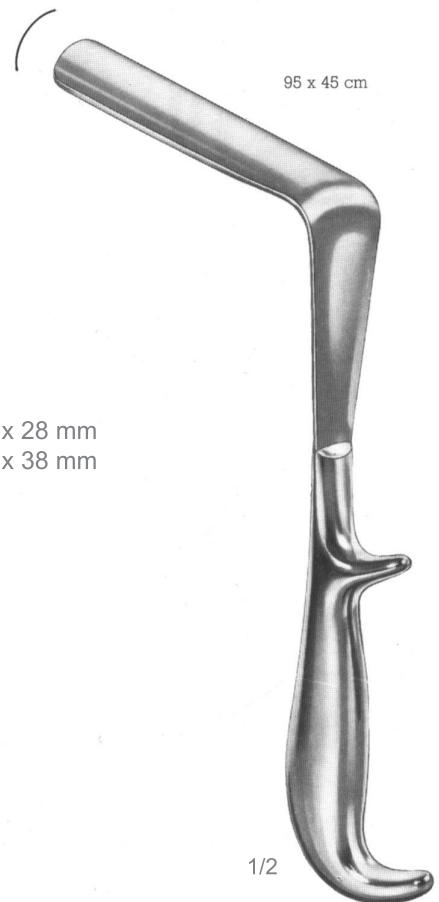

CB.340.22
Dunkel
Vaginal Specula and
Retractors

Vaginal Speculum, Retractor

SCHEIDENSPEKULUM, -HALTER, WUNDSPREIZER -
ESPÉCULO Y VALVAS VAGINALES, SEPARADORES

Kolpen

GYNECOLOGY
GYNÄKOLOGIE
GINECOLOGÍA

CB

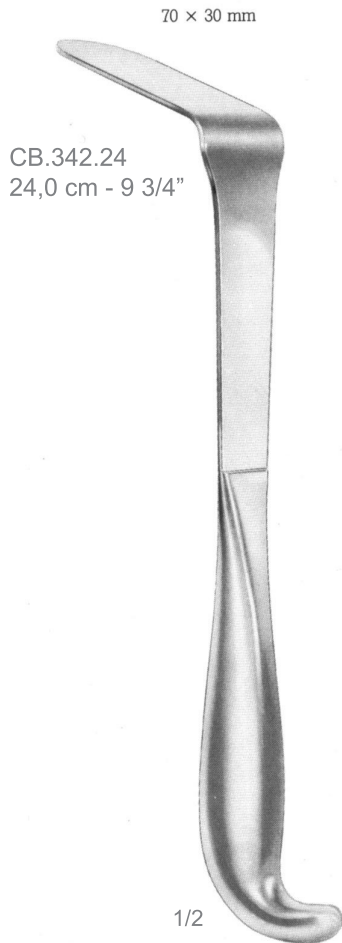

CB.342.24
Doyen
Vaginal Speculum,
Retractors



CB.351.00
O'Sullivan-O'Connor
Vaginal Speculum,
Retractors

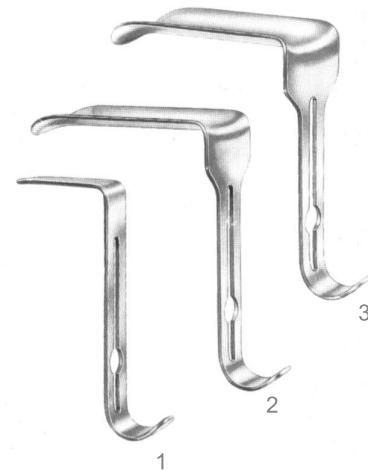

Fig. 1 45 x 17 mm
Fig. 2 90 x 37 mm
Fig. 3 90 x 45 mm

CB.342.24 - Vaginal Retractors

CB.351.00 - Vaginal Speculum, for examination and operative work, self-retaining, with adjustable frame, Loktite ratchet, 2 mobile lateral blades and 3 interchangeable blades fig. 1 - 3



CB.367.10
Friedman
Retractors,
Endospecula

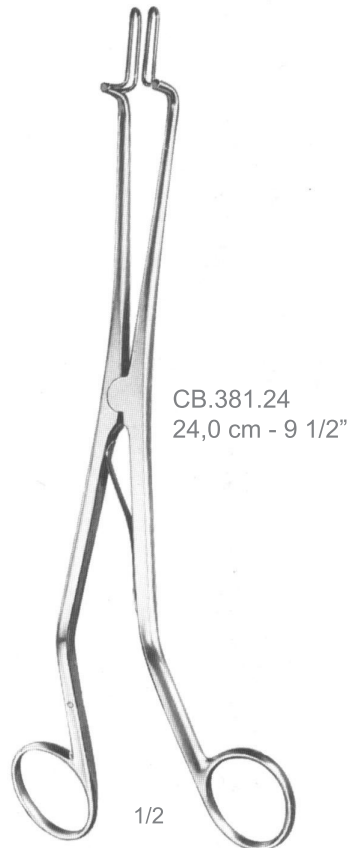

CB.381.24
Kogan
Retractors,
Endospecula



CB.383.24
Kogan
Retractors,
Endospecula

CB.367.10 - Retractor, self-retaining, for perineorrhaphy
CB.381.24 - without ratchet
CB.383.24 - with scale-ratchet and fixing screw

mm Ø	with sloped handle
1,0	CB.400.01
1,5	CB.401.01
2,0	CB.400.02
2,5	CB.401.02
3,0	CB.400.03
3,5	CB.401.03
4,0	CB.400.04
4,5	CB.401.04
5,0	CB.400.05
5,5	CB.401.05
6,0	CB.400.06
6,5	CB.401.06
7,0	CB.400.07
7,5	CB.401.07
8,0	CB.400.08
8,5	CB.401.08
9,0	CB.400.09
9,5	CB.401.09
10,0	CB.400.10
10,5	CB.401.10
11,0	CB.400.11
11,5	CB.401.11
12,0	CB.400.12
12,5	CB.401.12
13,0	CB.400.13
13,5	CB.401.13
14,0	CB.400.14
14,5	CB.401.14
15,0	CB.400.15
15,5	CB.401.15
16,0	CB.400.16
16,5	CB.401.16
17,0	CB.400.17
17,5	CB.401.17
18,0	CB.400.18
18,5	
19,0	CB.400.19
19,5	
20,0	CB.400.20
21,0	CB.401.21
22,0	CB.400.22
23,0	CB.401.23
24,0	CB.400.24
25,0	CB.401.25
26,0	CB.400.26



Set		pieces per set
CB.400.80	4,0 - 17,0	14
CB.400.90	1,0 - 26,0	26

CB



CB.400.84/94
Uterine Dilators

CB.400.84 - Set of 14 dilators CB.400.04 - CB.400.17 (4,0 - 17,0 mm Ø), in metal case with hinged lid

CB.400.94 - Set of 26 dilators CB.400.01 - CB.400.26 (1,0 - 26,0 mm Ø), in metal case with hinged lid



1/2

CB.400.84/94
Uterine Dilators

	mm Ø
CB.430.02	1,0/2,0
CB.430.04	3,0/4,0
CB.430.06	5,0/6,0
CB.430.08	8,0/8,0
CB.430.10	9,0/10,0
CB.430.12	11,0/12,0
CB.430.14	13,0/14,0
CB.430.16	15,0/16,0
CB.430.18	17,0/18,0
CB.430.20	19,0/20,0
CB.430.22	21,0/22,0
CB.430.24	23,0/24,0
CB.430.26	25,0/26,0

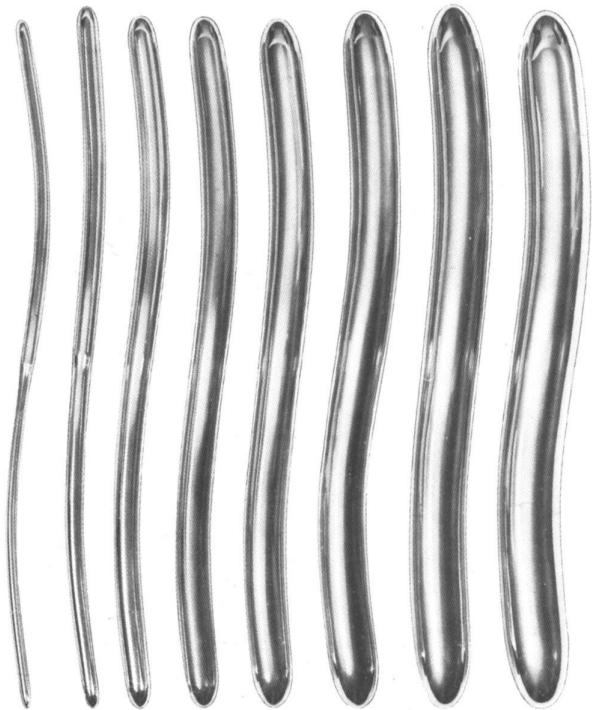

1/2

CB.430.80/90
Uterine Dilators

CB.430.80 - Set of 8 dilators 3.0/4.0 - 17.0/18.0 mm Ø

CB.430.90 - Set of 13 dilators 1.0/2.0 - 25.0/26.0 mm Ø

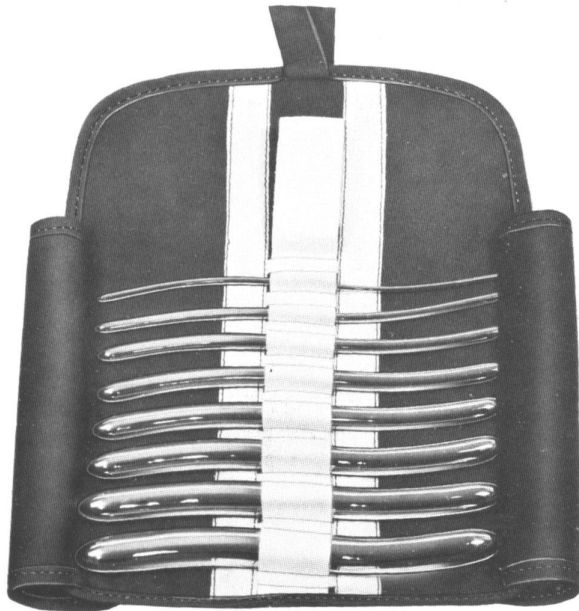

CB.430.82 - Set of 8 dilators 3.0/4.0 - 17.0/18.0 mm Ø,
in boilable canvas roll

CB.430.82
Uterine Dilators

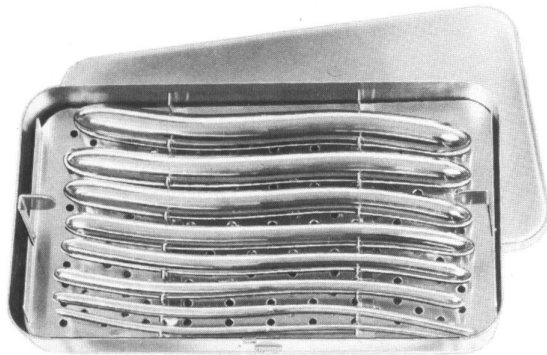

CB.430.84 - Set of 8 dilators 3.0/4.0 - 17.0/18.0 mm Ø,
in metal case with hinged lid

CB.430.84
Uterine Dilators



CB.430.94 - Set of 13 dilators 1.0/2.0 - 25.0/26.0 mm Ø,
in metal case with hinged lid

CB.430.94
Uterine Dilators

CB

American scale

Hank

CB.460.10 4,5/5 mm

CB.460.12 5,5/6 mm

CB.460.14 6,5/7 mm

CB.460.16 7,5/8 mm

CB.460.18 8,5/9 mm

CB.460.20 9,5/10 mm



1/2

1/2

CB.460.10/20
Hank
Uterine Dilators

CB.460.80
Hank
Uterine Dilators

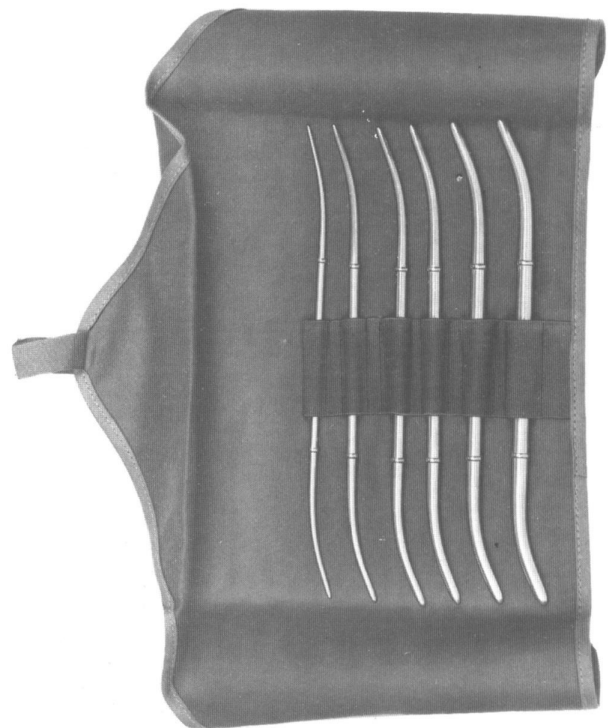

CB.460.82
Hank
Uterine Dilators

CB.460.80, CB.480.80
CB.460.82

- Set of 6 pieces
- Ditto, in canvas roll

Uterine Sounds and Depressors

UTERUSSONDEN, -DEPRESSOREN -
HISTERÓMETROS, DEPRESORES UTERINOS

Kolpen

GYNECOLOGY
GYNÄKOLOGIE
GINECOLOGÍA

CB

CB.583.32
CB.584.32
32,0 cm - 12 1/2"



CB.583.32
CB.584.32
Sims
Uterine Sounds
and Depressors

CB.585.32
CB.586.32
32,0 cm - 12 1/2"

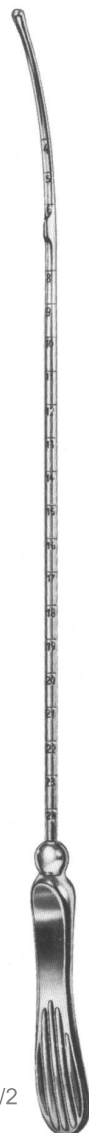

CB.585.32
CB.586.32
Martin
Uterine Sounds
and Depressors

CB.591.28
28,0 cm - 11"



CB.591.28
Collin
Uterine Sounds
and Depressors

CB.593.25
25,0 cm - 10"



CB.593.25
Valleix
Uterine Sounds
and Depressors

CB.595.26
28,0 cm - 11"

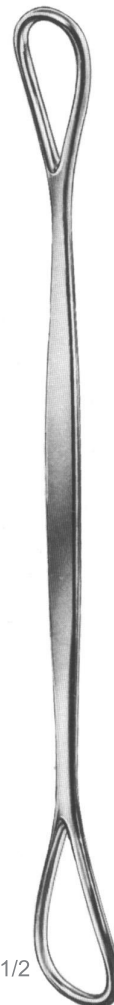

CB.595.26
Braun
Uterine Sounds
and Depressors

CB.599.32
32,0 cm - 12 1/2"

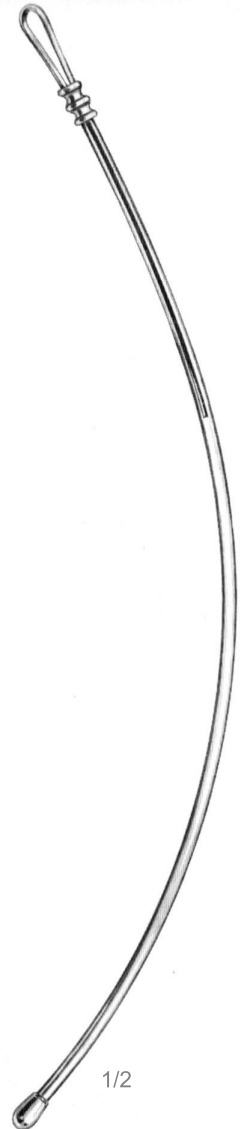

CB.599.32
Amann
Uterine Sounds
and Depressors

CB



CB.614.17
17,0 cm - 6 3/4"
Strong pattern

CB.614.17
Staude-Moore
Tenaculum Forceps



CB.616.18
18,0 cm - 7"

CB.616.18
Barrett
Tenaculum Forceps



CB.618.26
25,5 cm - 10 1/4"

CB.618.26
Pozzi
Tenaculum Forceps

Tenaculum Forceps

HAKENZANGEN - PIZAS PARA COGER EL CUELLO DEL ÚTERO

Kolpen

GYNECOLOGY
GYNÄKOLOGIE
GINECOLOGÍA

CB



CB.622.25
25,0 cm - 10"

CB.622.25
Schoeder
Tenaculum Forceps



CB.628.25
25,0 cm - 10"

CB.628.25
Braun
Tenaculum Forceps



CB.645.28
28,0 cm - 11"

CB.645.28
Duplay
Tenaculum Forceps

CB



CB.659.26
26,0 cm - 10 1/4"

Amniotome for the
amnion bladder

1/2

CB.659.26
Beacham
Tenaculum Forceps



CB.663.24
24,0 cm - 9 1/2"

1/2

CB.663.24
Skene
Tenaculum Forceps



CB.663.27
27,0 cm - 10 1/2"

with guide blades

1/2

CB.670.27
Abel
Tenaculum Forceps

Tenaculum Forceps

HAKENZANGEN - PIZAS PARA COGER EL CUELLO DEL ÚTERO

GYNECOLOGY
GYNÄKOLOGIE
GINECOLOGÍA

CB.699.26
26,0 cm - 10 1/4"
for the amnion bladder

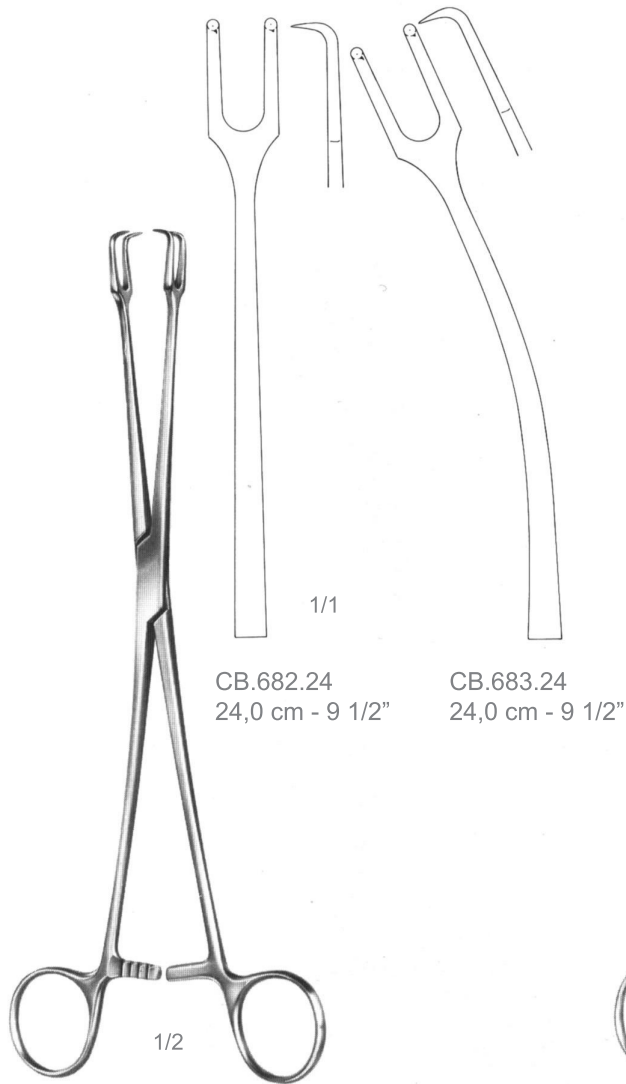

CB.682.24
24,0 cm - 9 1/2"

CB.683.24
24,0 cm - 9 1/2"

CB.682.24
CB.683.24
Schroeder
Tenaculum Forceps

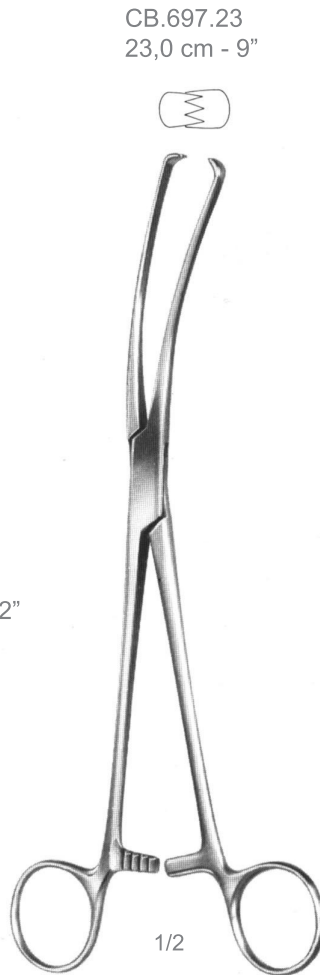

CB.697.23
23,0 cm - 9"

CB.697.23
Taele
Tenaculum Forceps

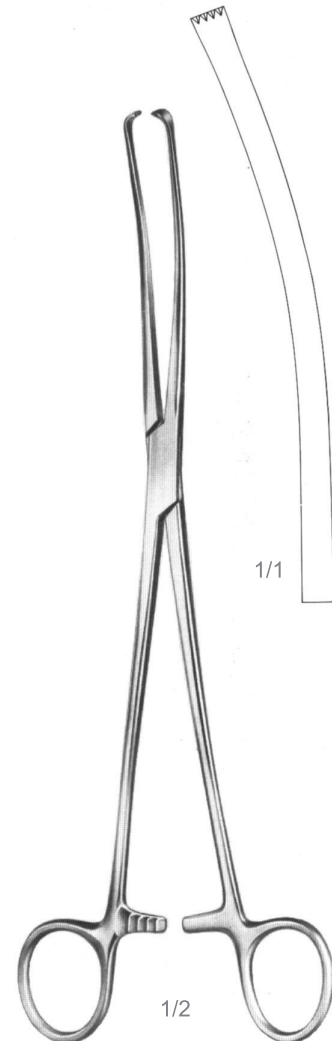

CB.699.26
Iowa
Tenaculum Forceps

CB



CB.702.24
CB.704.24
CB.706.24

Museux
Tenaculum Forceps

1/1			
CB.702.24	CB.704.24	CB.706.24	
24,0 cm -	24,0 cm -	24,0 cm -	
9 1/2"	9 1/2"	9 1/2"	
6 mm	8 mm	10 mm	

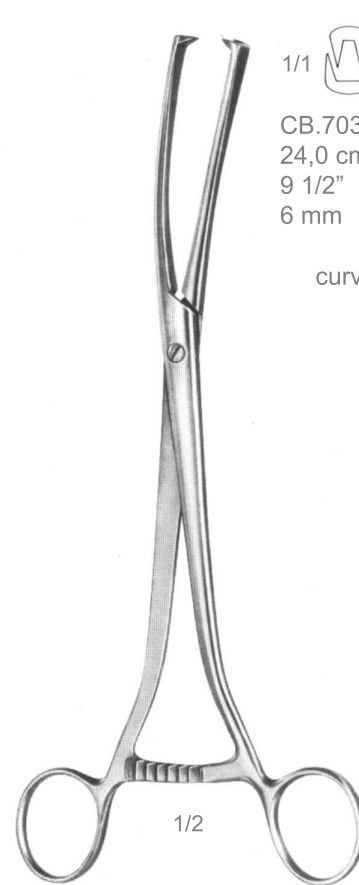

CB.703.24
CB.705.24
Museux
Tenaculum Forceps

1/1		
CB.703.24	CB.705.24	
24,0 cm -	24,0 cm -	
9 1/2"	9 1/2"	
6 mm	8 mm	

curved sideways

Tenaculum Forceps

HAKENZANGEN - PIZAS PARA COGER EL CUELLO DEL ÚTERO

Kolpen

GYNECOLOGY
GYNÄKOLOGIE
GINECOLOGÍA

CB

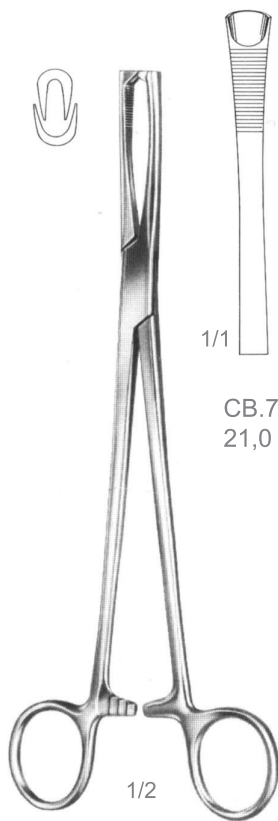

1/1

CB.728.21
21,0 cm - 8 1/4"

1/2

CB.728.21
Jacobs
Tenaculum Forceps



1/1

CB.732.20
20,5 cm - 8"

1/2

CB.732.20
Henrotin
Tenaculum Forceps

CB



CB.734.26
26,0 cm - 10 1/4"

1/2

CB.734.26
Tenaculum Forceps



CB.738.16
15,5 cm - 6 1/4"

1/2

CB.738.16
Braun
Tenaculum Forceps



CB.740.21
20,5 cm - 8 1/4"

1/2

CB.740.21
Czerny
Tenaculum Forceps

Uterine Polypus Forceps

UTERUS-POPLYPENZANGEN - PINZAS PARA PÓLIPOS UTERINOS

Kolpen

GYNECOLOGY
GYNÄKOLOGIE
GINECOLOGÍA

CB

CB.741.32
32,0 cm - 12 1/2"

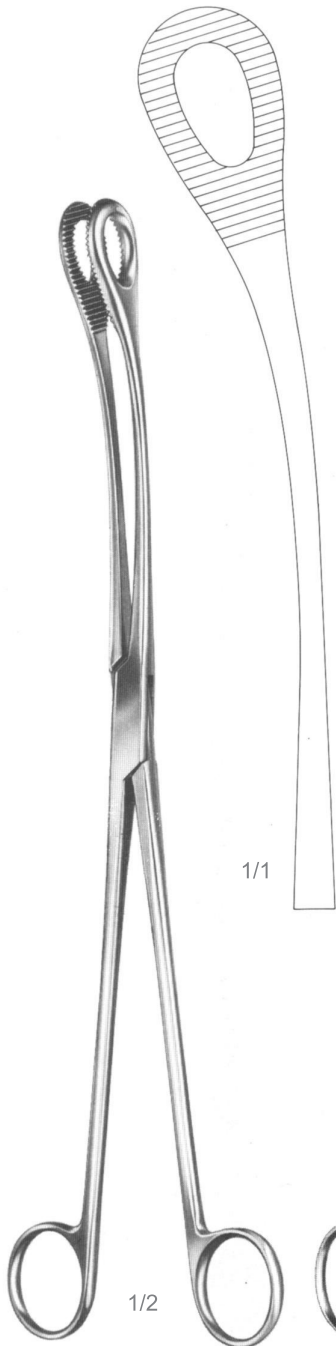

CB.741.32

Kelly
Uterine
Polypus
Forceps

CB.744.27
27,0 cm - 10 1/2"

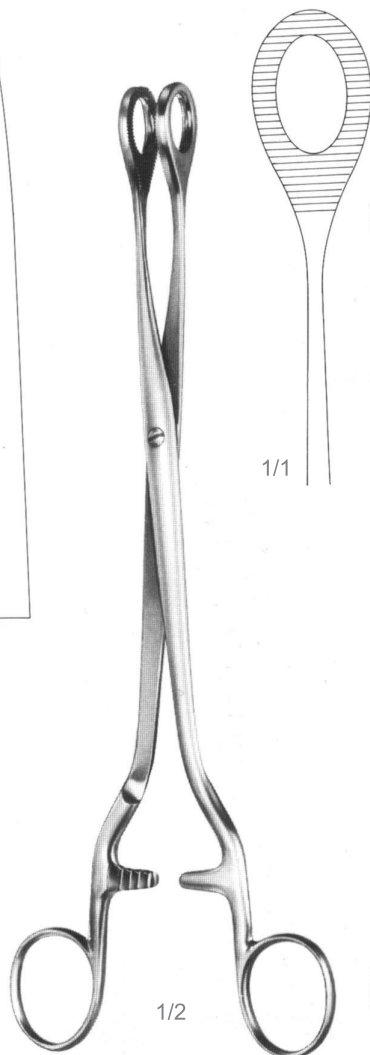

CB.744.27

Noto
Uterine
Polypus
Forceps

CB.745.25
25,0 cm - 9 3/4"

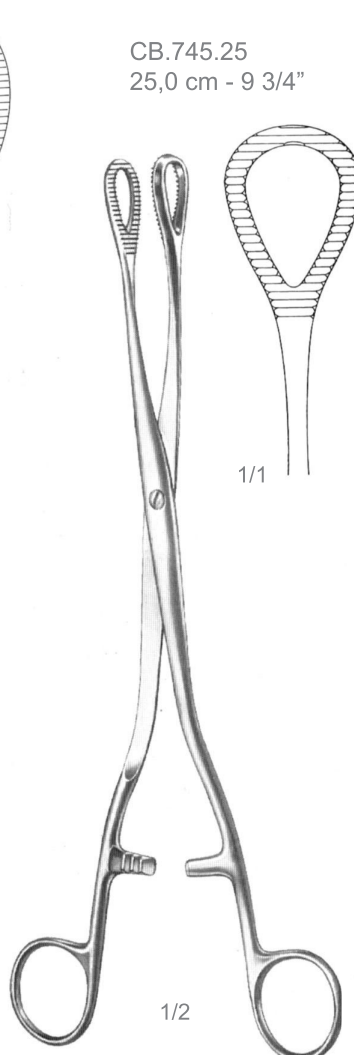

CB.745.25

Heywood-Smith
Uterine
Polypus
Forceps

CB.756.20
20,0 cm - 8"

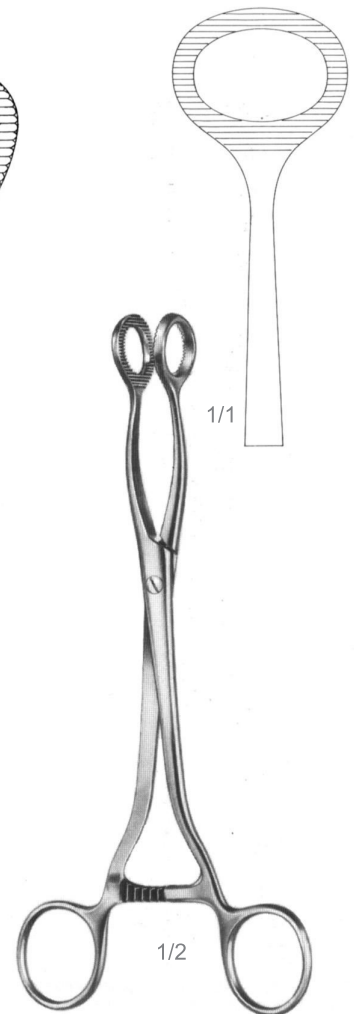

CB.756.20

Doyen
Uterine
Polypus
Forceps

CB

CB.757.17
17,0 cm - 6 3/4"



CB.757.17
Doyen
Myoma Instruments

CB.759.17
17,0 cm - 6 3/4"



CB.759.17
Doyen
Myoma Instruments

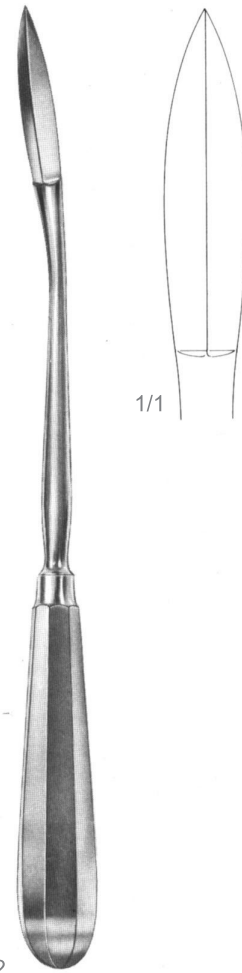

CB.762.27
Segond
Myoma Instruments

Uterine Elevating Forceps

UTERUS-FABZANGEN - PINZAS PARA EL ÚTERO

Kolpen

GYNECOLOGY
GYNÄKOLOGIE
GINECOLOGÍA

CB

CB.773.27
27,0 cm - 10 1/2"

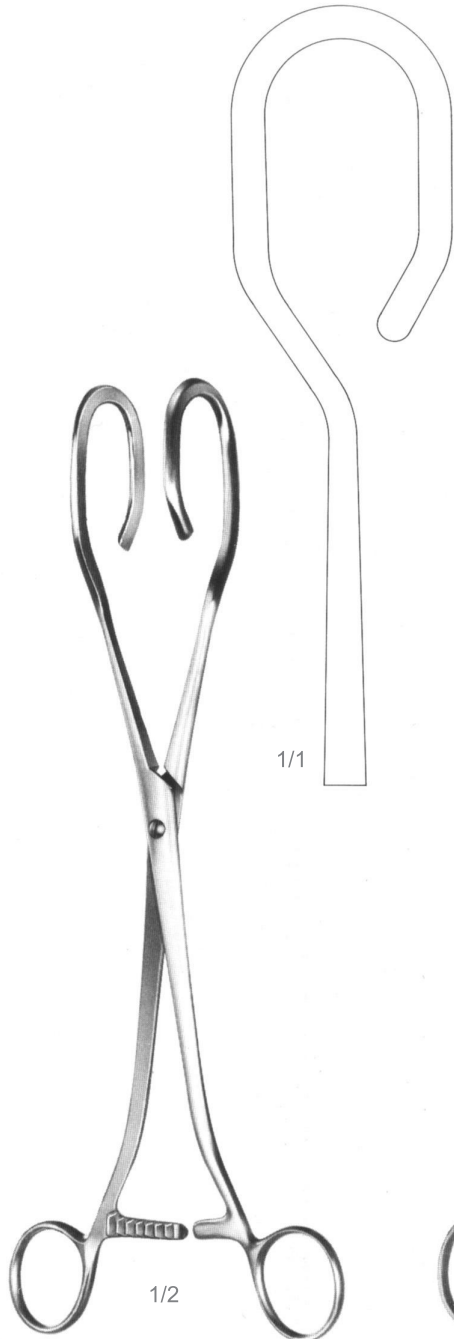

CB.773.27
Dartigues
Uterine Elevating
Forceps

CB.779.23
23,0 cm - 9"



CB.779.23
Somer
Uterine Elevating
Forceps

CB.793.25
25,0 cm - 10"



CB.793.25
Collin
Uterine Elevating
Forceps

CB

CB.801.23
23,0 cm - 9"

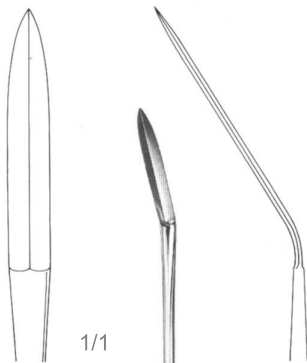

1/1

1/2

CB.801.23
Ayre
Fistula Hooks,
Cone Knives

CB.804.22
22,0 cm - 8 3/4"

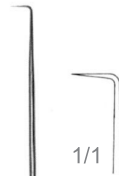

1/1

1/2

CB.804.22
Emmett
Fistula Hooks,
Cone Knives

CB.806.22
22,0 cm - 8 3/4"



1/2

CB.806.03
Simon
Fistula Hooks,
Cone Knives

CB.808.22
22,0 cm - 8 3/4"



1/2

CB.808.22
Simon
Fistula Hooks,
Cone Knives

Suction Biopsy Curettes

SAUG- UND BIOPSIKÜRETTEN - CURETAS ASPIRADORAS PARA BIOPSIA

Kolpen

GYNECOLOGY
GYNÄKOLOGIE
GINECOLOGÍA

CB

CB.821.24
24,0 cm - 9 1/2"
4 mm Ø

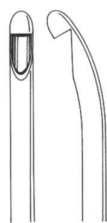

1/1



1/2

CB.821.24
Randall
Suction Biopsy
Curettes

CB.825.23
23,0 cm - 9"
4 mm Ø

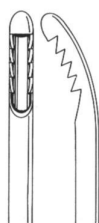

1/1



1/2

CB.825.23
Novak
Suction Biopsy
Curettes

CB.827.30
30,0 cm - 12"



1/2

CB.827.30
Kevorkian
Suction Biopsy
Curettes

CB.829.27
37,0 cm - 10 1/2"

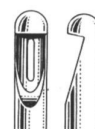

1/1



1/2

CB.829.27
Kevorkian
Suction Biopsy
Curettes

CB.821.24 - CB.825.23 - Endometrial Suction Biopsy Curettes
CB.827.30 - Biopsy curette
CB.829.27 - Ditto

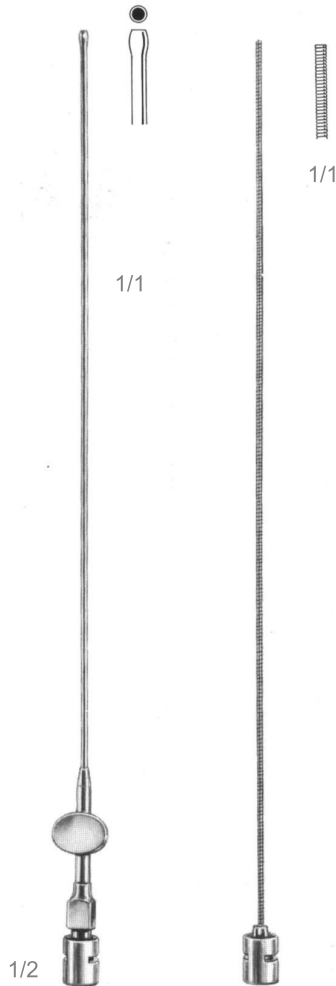

CB.830.00/01

Kloosterman
Transcervical
Aspiration Instrument

Transcervical Aspiration Instrument for Chorion Villus Sampling in Prenatal Diagnosis acc. to Dr. Kloosterman

Advantages

- Optimal visibility with ultrasound.
- Less traumatic because of the bulbshaped end.
- Even when strongly flexed the obturator is extremely easy to remove.
- After removal of the obturator the catheter is still easy to manipulate in all directions
- The placenta area is easy accesible due to the softness of the catheter, even in case of an unfavorable position of the uterus.
- Cost is minimal due to durability and reusability.

Developed in cooperation with:

Dr. M. D. Kloosterman, Diakonessenhuis
Arnhem, Niederlande

CB.830.00 - Set, complete, 27 cm, 2 mm Ø

CB.830.01 - Mandrel, only



1/1

CB.841.23
23,0 cm - 9"

1/2

CB.841.23
Gellhorn
Cervical Biopsy and
Specimen Forceps



1/1

CB.843.21
21,0 cm - 8 1/4"

1/2

CB.843.21
Faure
Cervical Biopsy and
Specimen Forceps

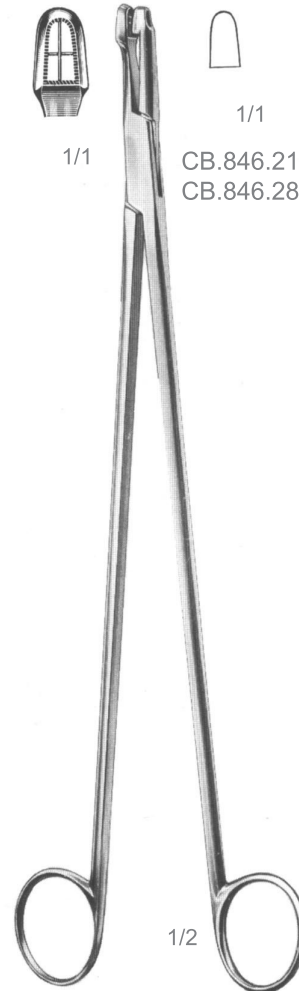

1/1

CB.846.21 21,0 cm - 8 1/4"
CB.846.28 29,0 cm - 11 1/2"

1/1

1/2

CB.846.21
CB.846.28
Schubert
Cervical Biopsy and
Specimen Forceps

CB



CB.849.24
24,0 cm - 9 1/2"

CB.849.24
Thoms-Gaylor
Cervical Biopsy and
Specimen Forceps



CB.851.22 22,0 cm - 8 1/2"
CB.851.24 24,0 cm - 9 1/2"

CB.851.22/24
Thoms-Gaylor
Cervical Biopsy and
Specimen Forceps

Its S-shaped construction allows clear view and sharply-delineated excisions.



CB.853.26 26,0 cm - 10 1/4"

CB.853.26
Schubert
Cervical Biopsy and
Specimen Forceps

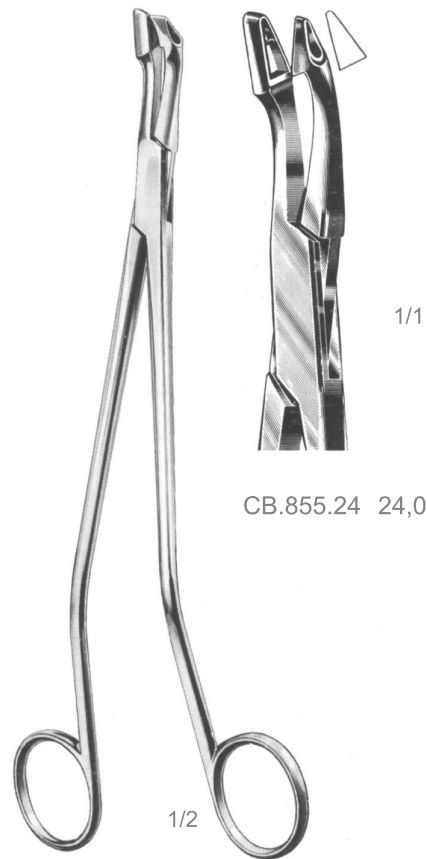

CB.855.24 24,0 cm - 9 1/2"

CB.855.24
van Doren
Cervical Biopsy and
Specimen Forceps

CB

Its S-shaped construction allows clear view and sharply-delineated excisions.



CB.855.25
25,0 cm - 10"

CB.855.25
van Doren
Cervical Biopsy and
Specimen Forceps

1/2

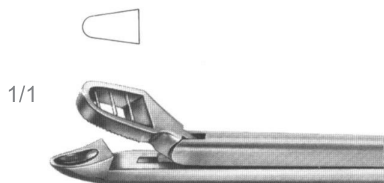

Jaws cut with a pulling motion from point to rear.
Cutting edge planted into tissue.
Better view as jaws are curved to left.

CB.857.28
28,0 cm - 11"



CB.857.28
Alexander
Cervical Biopsy and
Specimen Forceps

1/2

CB.857.28 - can be used in colposcopy

Cervical Biopsy and Specimen Forceps

PROBEEEXZISIONSZANGEN - PINZAS SACA-BOCADOS PARA BIOPSIA

Kolpen

GYNECOLOGY
GYNÄKOLOGIE
GINECOLOGÍA

CB

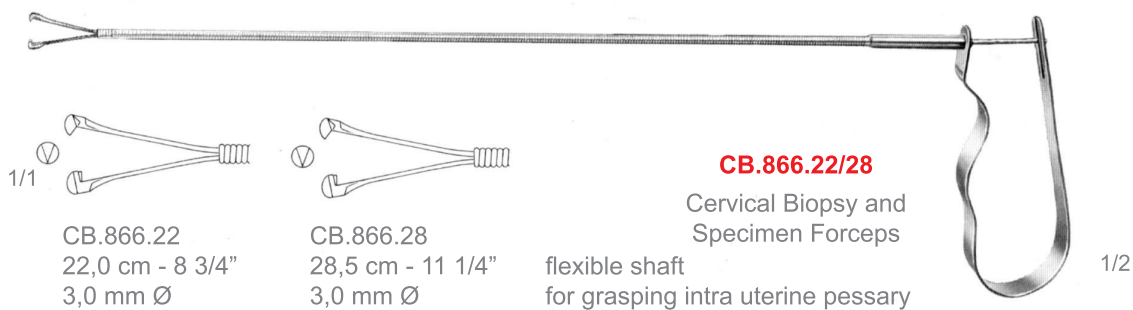
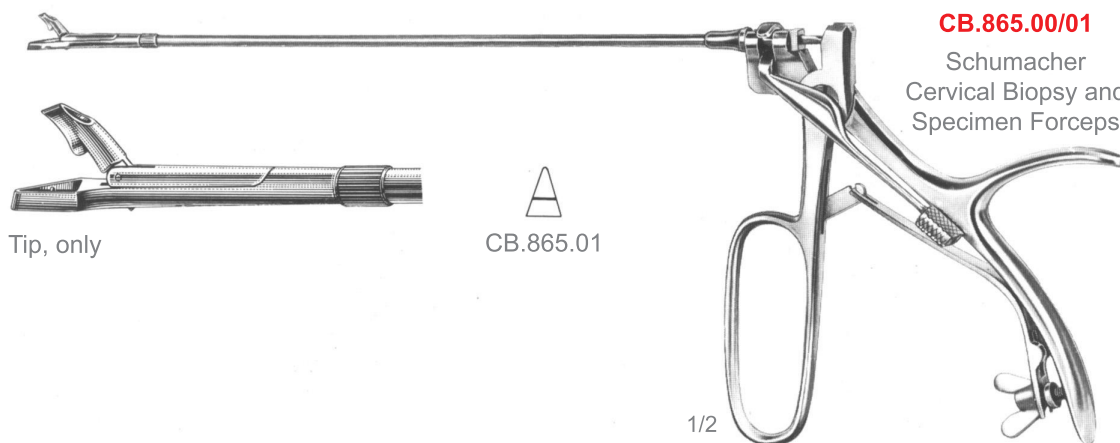
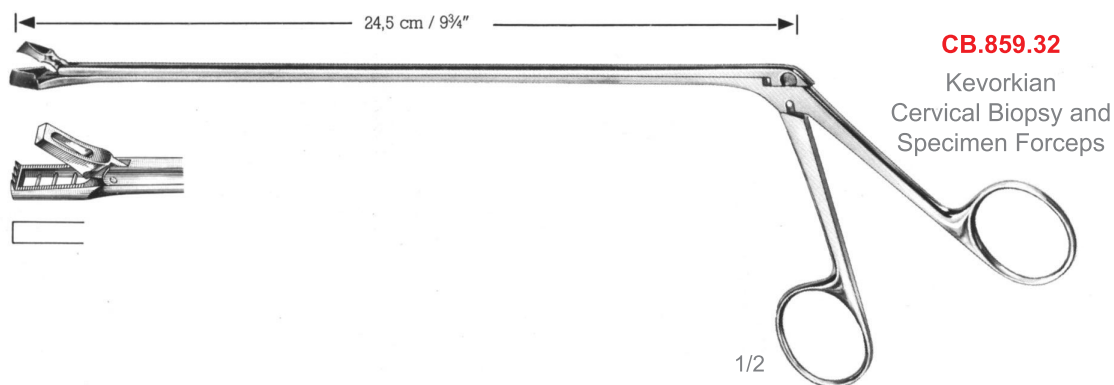
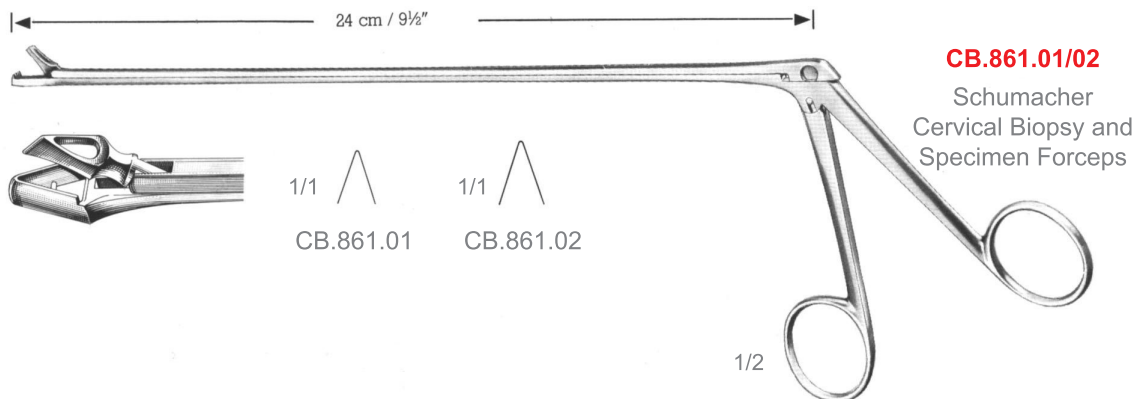

faltan fotos

CB.862.22

CB.863.20

CB.864.22

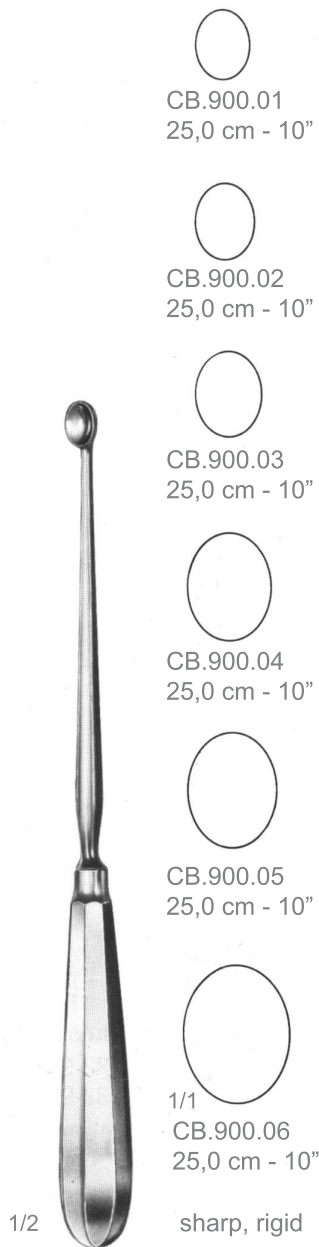

CB.900.01/06
Simon
Uterine Scoops

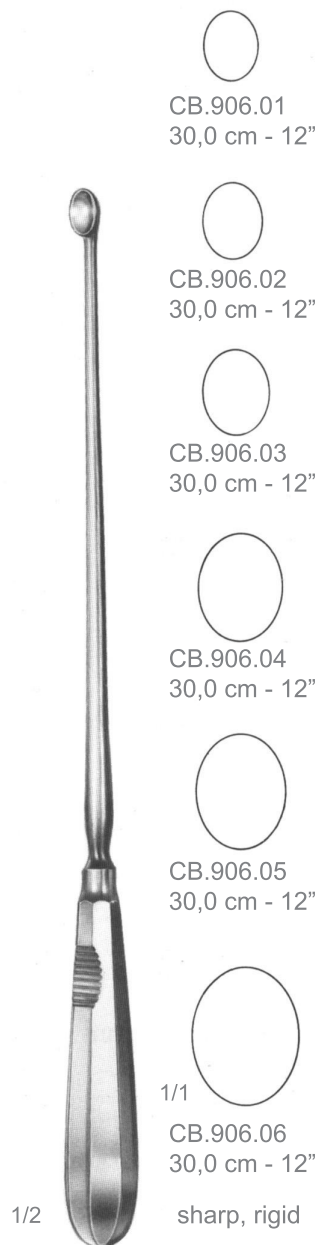

CB.906.01/06
Schroeder
Uterine Scoops

CB

CB.920.05/40
31,0 cm - 12 1/2"
rigid
sharp

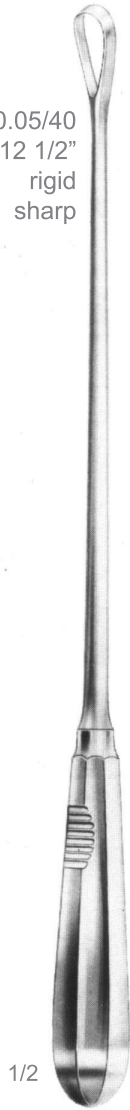

1/2

CB.920.05/40 CB.921.05/40

Recaimer - Sims - Bumm
Uterine Curettes

CB.921.05/40
31,0 cm - 12 1/2"
malleable
sharp

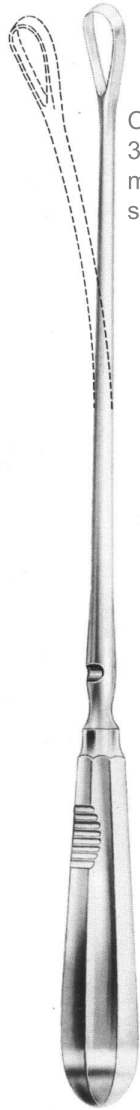

CB.926.05/40
31,0 cm - 12 1/2"
rigid
blunt

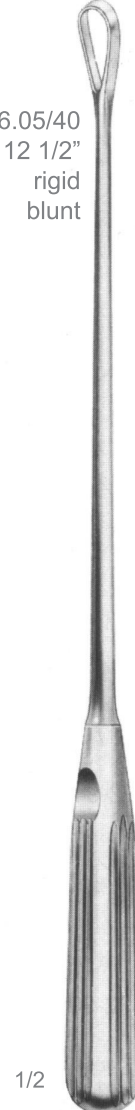

1/2

CB.926.05/40 CB.927.05/40

Recaimer - Sims - Bumm
Uterine Curettes

CB.927.05/40
31,0 cm - 12 1/2"
malleable
blunt

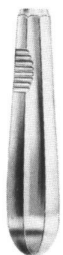
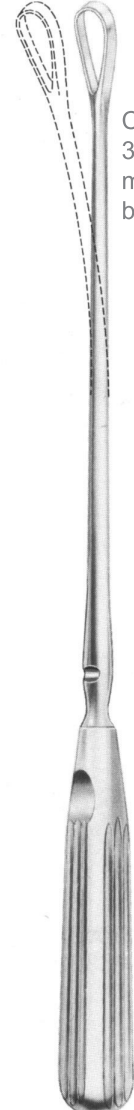

Sharps Curettes
(Recaimer Handle)



Malleable Curettes
(grooved shaft)



Rigid Curettes
(Plain shaft)



Blunt Curettes
(Sims Handle)

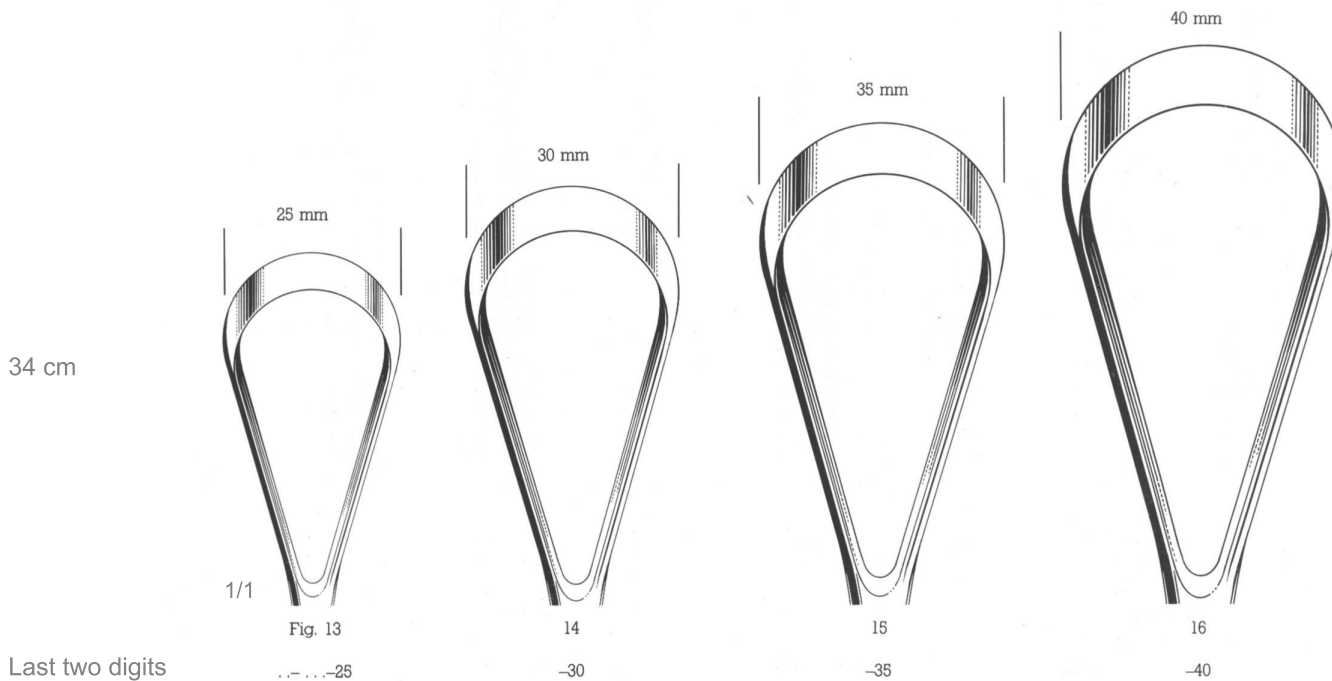
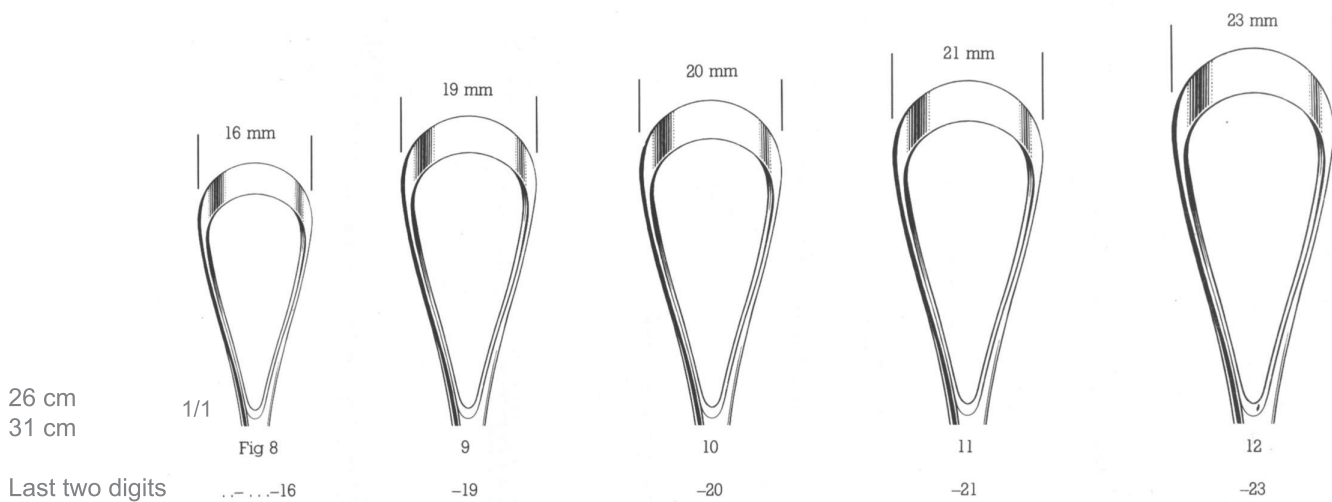
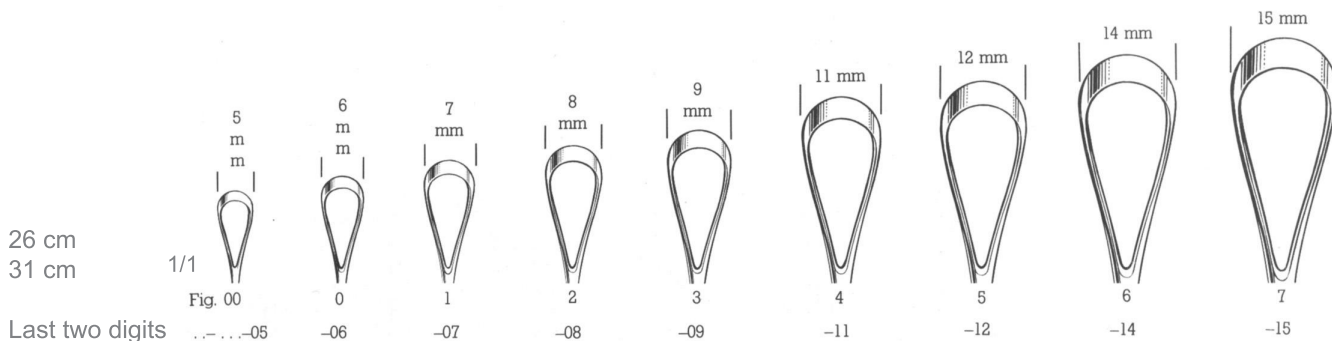

Recaimer - Sims - Bumm
Uterine Curettes

CB



CB.989.03/50
Aspirating Curettes

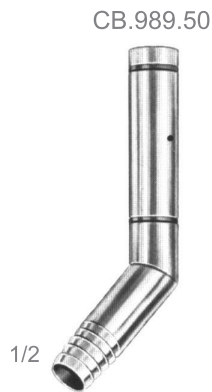

CB.989.03 3 mm Ø
CB.989.04 4,5 mm Ø
Specimen and Aspirating Curettes

CB.989.06 6 mm Ø
CB.989.08 8 mm Ø
CB.989.10 10 mm Ø
CB.989.12 12 mm Ø
CB.989.14 14 mm Ø
Aspirating Curettes

CB.995.00 Salpingograph for diagnosis and treatment of sterility,
for injections of Lipiodol into the uterus and the Fallopian

Tubes, for intra-uterine insufflation and for diagnosis
by X-rays, consisting of:

- Main Attachments with adjustable forceps holders,
- Connecting Piece,
- Manometer with luminous dial,
- Luer-Lock Syringe of 10 ccm,
- 3 Interchangeable Occlusive Nozzles, of metal,
of 3 different size
- complete in wooden case

CB.995.02 ditto, but **without** manometer

CB.995.02 Manometer with luminous dial, only

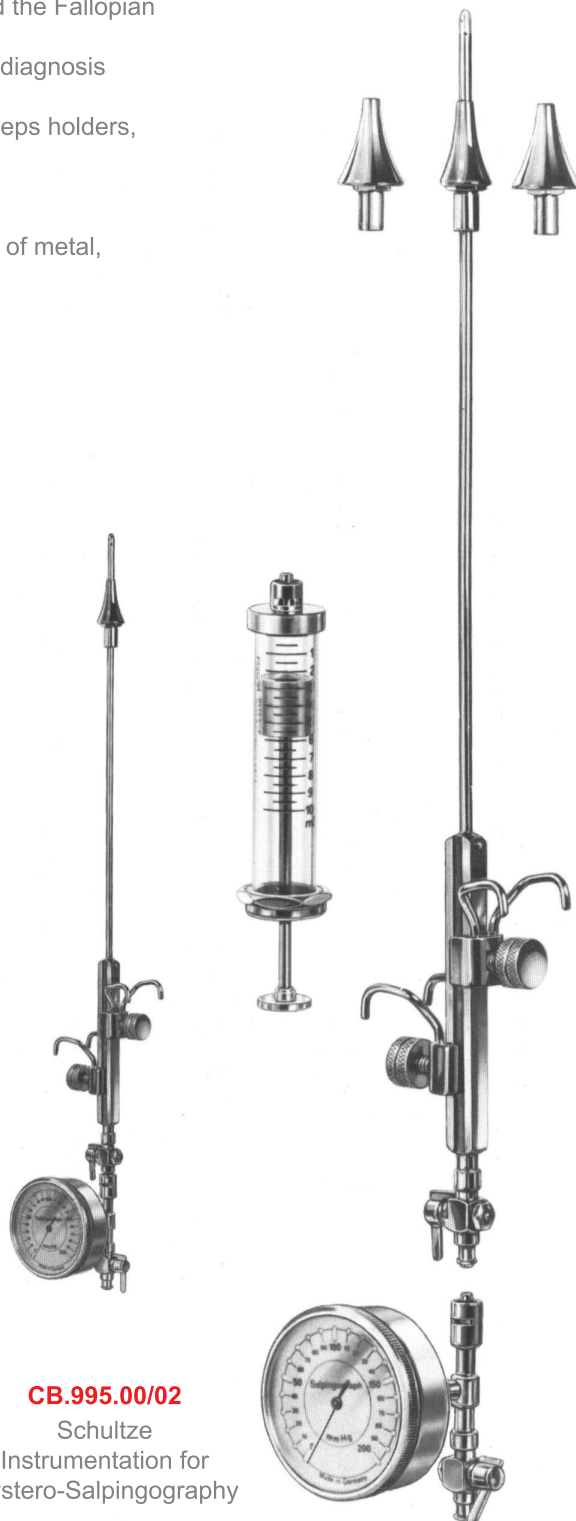

CB.995.00/02
Schultze
Instrumentation for
Hystero-Salpingography