

Kolpen

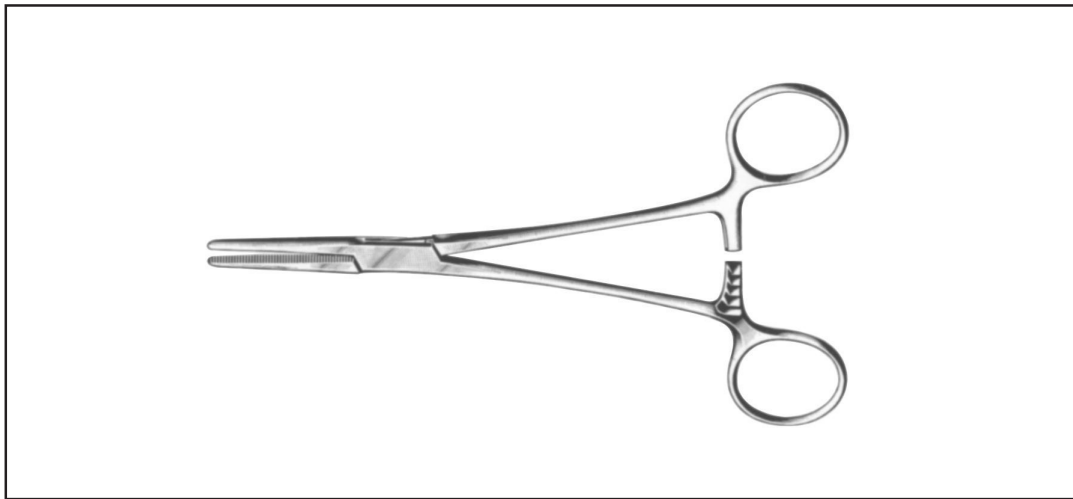

AC

AC

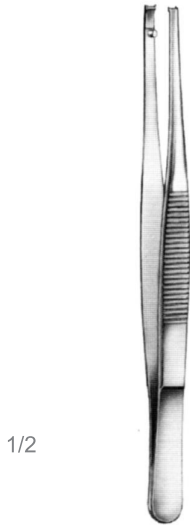

1/2

AC.050.14

AC.050.14 14,5 cm - 5 3/4"
Without lock
Clip Applying Forceps
Vessel Clips



1/2

AC.051.14

AC.051.14 14,5 cm - 5 3/4"
With lock
Clip Applying Forceps
Vessel Clips



AC.052.04/05
AC.053.05
Biemer
Clip Applying Forceps
Vessel Clips



AC.052.04
AC.052.05
4 mm. Jaw Opening
6 mm. Jaw Length
30-40 gr. Closing Pressure



AC.053.05
4 mm. Jaw Opening
6 mm. Jaw Length
30-40 gr. Closing Pressure

1/1



AC.054.05
AC.055.05
AC.056.03
AC.058.05
AC.059.05

Biemer-Müller
Approximators



AC.054.05
Straigh
5 mm. Jaw Opening
9 mm. Jaw Length
25-30 gr. Closing Pressure



AC.055.05
Angled
5 mm. Jaw Opening
9 mm. Jaw Length
25-30 gr. Closing Pressure



AC.056.03
Straigh
3 mm. Jaw Opening
4,5 mm. Jaw Length
25-30 gr. Closing Pressure



AC.058.05
Straight
5 mm. Jaw Opening
9 mm. Jaw Length
25-30 gr. Closing Pressure



AC.059.05
Angled
5 mm. Jaw Opening
9 mm. Jaw Length
25-30 gr. Closing Pressure



1/1

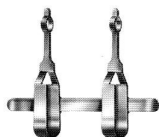

AC.060.01/04
Müller
Approximators

AC.060.01
1 mm. Diameter
25-30 gr. Closing Pressure

AC.060.02
2 mm. Diameter
25-30 gr. Closing Pressure

AC.060.03
3 mm. Diameter
25-30 gr. Closing Pressure

AC.060.04
4 mm. Diameter
25-30 gr. Closing Pressure

AC



AC.062.00
Complete with Key



AC.062.01
Key for Approximator



AC.062.02
Approximator, only

AC.062.00/02

Approximators
Nerve Approximators
For micro vessel anastomosis in the depth

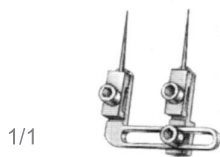

AC.063.00
Complete with Key

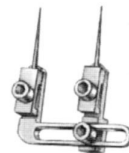

AC.063.02
Approximator
with needles, only

AC.063.04
Spare needles, only
Pair

AC.063.00/04

Approximators
Nerve Approximators
Needles exchangeable by means of key

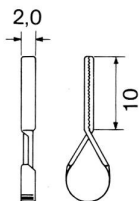

AC.102.10
10 mm. Length of Jaw
2 mm. Width of Jaw
125 grs. Occlusion pressure

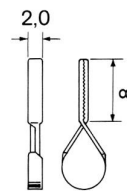

AC.102.08
8 mm. Length of Jaw
2 mm. Width of Jaw
100 grs. Occlusion pressure



AC.102.04/10
Serrefines,
Setting Forceps

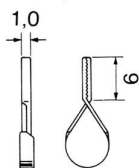

AC.102.06
6 mm. Length of Jaw
1 mm. Width of Jaw
85 grs. Occlusion pressure

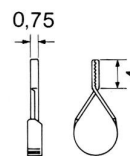

AC.102.04
4 mm. Length of Jaw
0,75 mm. Width of Jaw
60 grs. Occlusion pressure



1/2

AC.106.18
18,0 cm 7"









AC.106.18
Serrefines,
Setting Forceps





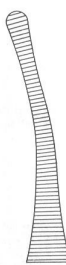

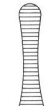

1/2

AC.104.14
14,0 cm 5 1/2"

AC.104.14
Serrefines,
Setting Forceps

 <p>AC.110.06 AC.111.06 AC.114.03/05 AC.115.03/05 Dieffenbach Bulldog Clamps</p>	1/1	 AC.110.06 6,0 cm 2 1/2"	 AC.111.06 6,0 cm 2 1/2"	 <p>AC.119.05/07 Johns Jopkins Bulldog Clamps</p>	 <p>1/1 AC.119.05 5,0 cm 2" AC.119.06 6,5 cm 2 1/2" AC.119.07 7,5 cm 3"</p>
	 AC.114.03 3,5 cm 1 1/2"	 AC.115.03 3,5 cm 1 1/2"			
	 AC.114.05 5,0 cm 2"	 AC.115.05 5,0 cm 2"			

 <p>AC.120.08/12 AC.121.08/12 Bulldog Clamps</p>	 AC.120.08 50 mm. Length 8 mm. Jaws 3 grs. Weight 50 grs. Pressure	 AC.120.10 50 mm. Length 12 mm. Jaws 3 grs. Weight 50 grs. Pressure	 AC.120.12 60 mm. Length 20 mm. Jaws 3 grs. Weight 50 grs. Pressure
	 AC.121.08 50 mm. Length 8 mm. Jaws 3 grs. Weight 50 grs. Pressure	 AC.121.10 50 mm. Length 12 mm. Jaws 3 grs. Weight 50 grs. Pressure	 AC.121.12 60 mm. Length 20 mm. Jaws 3 grs. Weight 50 grs. Pressure

1/1



AC.132.30/50 Vena
AC.142.30/50 Arteria

Titanium Atrauma
Bulldog Clamps



Vena	
AC.132.30	3,0 cm
AC.132.35	3,5 cm
AC.132.40	4,0 cm
AC.132.50	5,0 cm



Arteria	
AC.142.30	3,0 cm
AC.142.35	3,5 cm
AC.142.40	4,0 cm
AC.142.50	5,0 cm

1/1



AC.133.30/50 Vena
AC.143.30/50 Arteria

Titanium Atrauma
Bulldog Clamps



Vena	
AC.133.30	3,0 cm
AC.133.35	3,5 cm
AC.133.40	4,0 cm
AC.133.50	5,0 cm



Arteria	
AC.143.30	3,0 cm
AC.143.35	3,5 cm
AC.143.40	4,0 cm
AC.143.50	5,0 cm

1/1



AC.135.30/50 Vena
AC.145.30/50 Arteria

Titanium Atrauma
Bulldog Clamps



Vena	
AC.135.30	3,0 cm
AC.135.35	3,5 cm
AC.135.40	4,0 cm
AC.135.50	5,0 cm



Arteria	
AC.145.30	3,0 cm
AC.145.35	3,5 cm
AC.145.40	4,0 cm
AC.145.50	5,0 cm

Kolpen

Artery Forceps

GENERAL INSTRUMENTS
ALLGEMEINES INSTRUMENTARIUM
INSTRUMENTAL GENERAL

ARTERIENKLEMMEN - PINZAS HEMOSTÁTICAS

AC



1/2

1/1



AC.150.10
10,0 cm 4"

AC.150.10

Carrel
Artery Forceps



1/2

1/1



AC.154.10
10,0 cm 4"

AC.154.10

Terrier
Artery Forceps



1/1

AC.182.13
13,0 cm 5"

AC.182.13

Kroenlein
Artery Forceps

AC.176.14/16

Artery Forceps



1/1

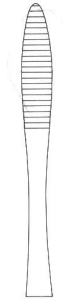

AC.176.14 14,0 cm 5 1/2"
AC.176.16 16,0 cm 6 1/4"



AC.248.13/20
AC.249.13/20

Spencer-Wells
Artery Forceps



AC.248.13 13,0 cm 5"
AC.248.14 14,0 cm 5 1/2"
AC.248.15 15,0 cm 6"
AC.248.18 18,0 cm 7"
AC.248.20 20,0 cm 8"



AC.249.13 13,0 cm 5"
AC.249.14 14,0 cm 5 1/2"
AC.249.15 15,0 cm 6"
AC.249.18 18,0 cm 7"
AC.249.20 20,0 cm 8"

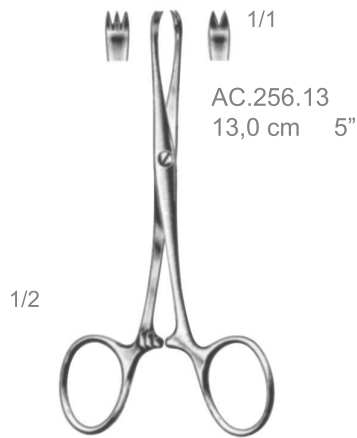

AC.256.13

Chaput
Tissue and organ
holding Forceps

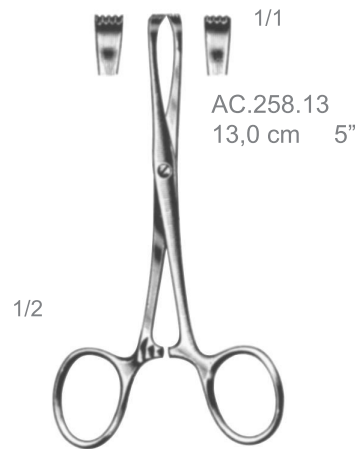

AC.258.13

Tuffier
Tissue and organ
holding Forceps



AC.266.25/26

Tissue and organ
holding Forceps
Atrauma



AC.268.14

Collin
Tissue and organ
holding Forceps

AC



AC.278.17

Collin
Tissue and organ
holding Forceps

1/1

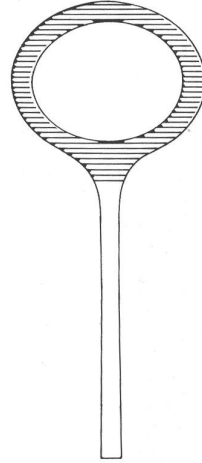

AC.278.17 16,5 cm 6 1/2"



AC.280.15/20

Pennington
Tissue and organ
holding Forceps

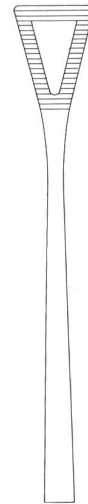

AC.280.15 15,5 cm 6"
AC.280.20 20,0 cm 8"

Artery Forceps, Angiotribes

ARTERIENKLEMMEN, DRUCKKLEMMEN - PINZAS HEMOSTÁTICAS,
PINZAS-CLAMPS DE PRESIÓN PROGRESIVA

Kolpen

GENERAL INSTRUMENTS
ALLGEMEINES INSTRUMENTARIUM
INSTRUMENTAL GENERAL

AC



AC.282.15
Pratt
Artery Forceps,
Angiotribes

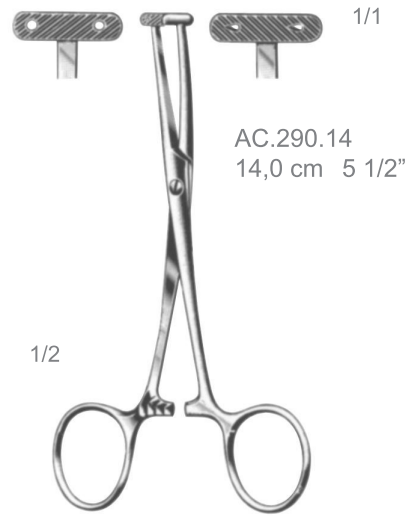

AC.290.14
Martel
Artery Forceps,
Angiotribes

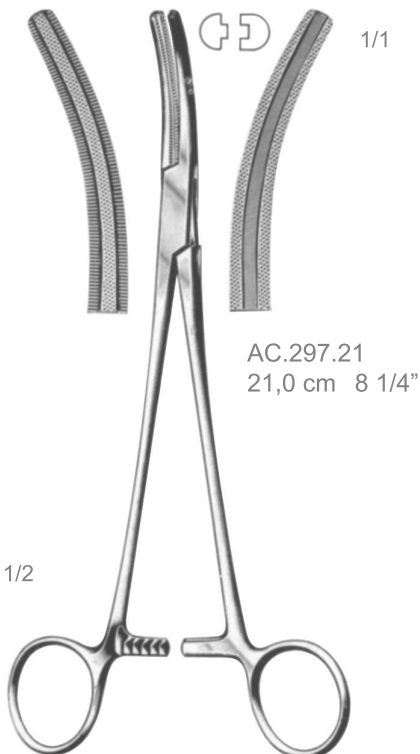

AC.297.21
Buie
Artery Forceps,
Angiotribes

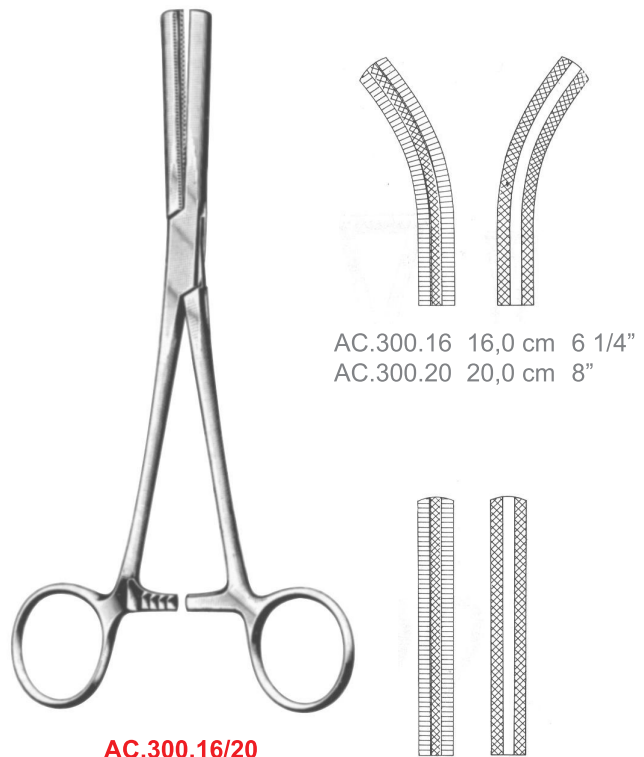

AC.300.16/20
AC.301.16/20
Fergusson
Artery Forceps,
Angiotribes

AC.301.16 16,0 cm 6 1/4"
AC.301.20 20,0 cm 8"

AC

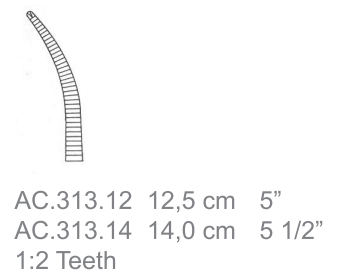
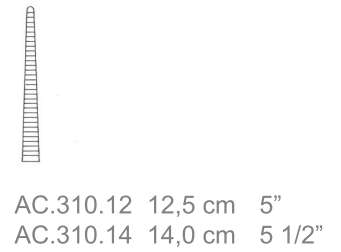
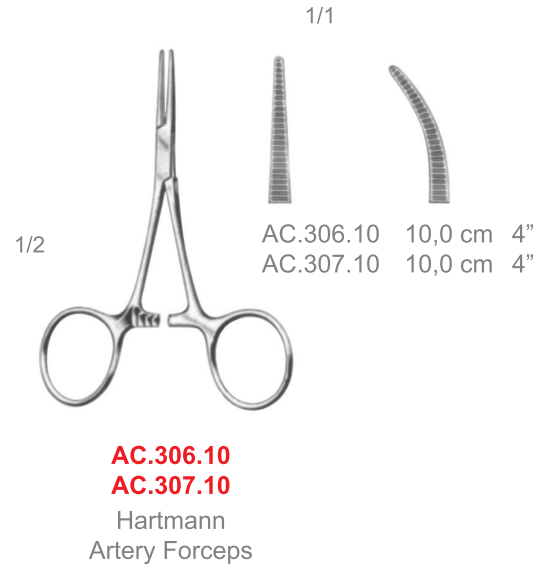

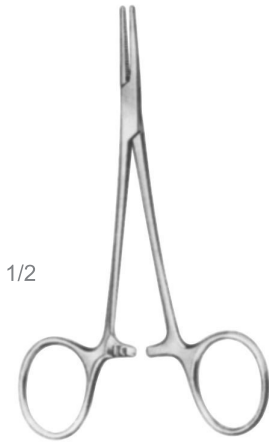

1/2

AC.310.62
AC.311.62
AC.312.62
AC.313.62

Halsted-Mosquito
Titanium
Artery Forceps

1/1



AC.310.62
12,0 cm 4 3/4"



AC.311.62
12,0 cm 4 3/4"



AC.312.62
12,0 cm 4 3/4"
1:2 Teeth



AC.313.62
12,0 cm 4 3/4"
1:2 Teeth



AC.316.18/21
AC.317.18/21
AC.318.18/21
AC.319.18/21

Halsted-Mosquito
Artery Forceps

1/1



AC.316.18 18,0 cm 7"
AC.316.21 21,0 cm 8 1/4"

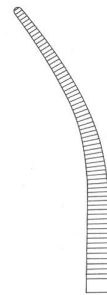

AC.317.18 18,0 cm 7"
AC.317.21 21,0 cm 8 1/4"



AC.318.18 18,0 cm 7"
AC.318.21 21,0 cm 8 1/4"
1:2 Teeth

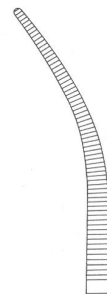

AC.319.18 18,0 cm 7"
AC.319.21 21,0 cm 8 1/4"
1:2 Teeth

AC



AC.320.10/12
AC.321.10/12
AC.322.10/12
AC.323.10/12

Micro-Mosquito
Artery Forceps



AC.320.10 10,0 cm 4"
AC.320.12 12,0 cm 4 4/4"



AC.321.10 10,0 cm 4"
AC.321.12 12,0 cm 4 4/4"



AC.322.10 10,0 cm 4"
AC.322.12 12,0 cm 4 4/4"
1:2 Teeth



AC.323.10 10,0 cm 4"
AC.323.12 12,0 cm 4 4/4"
1:2 Teeth



AC.324.14
AC.325.14

Providence-Hospital
Artery Forceps



1/1

AC.324.14
14,0 cm 5 1/2"



AC.325.14
14,0 cm 5 1/2"



AC.326.15
AC.327.15
AC.328.15
AC.329.15

Leriche
Artery Forceps



1/1

AC.326.15
15,0 cm 6"

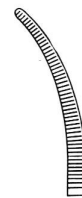

AC.327.15
15,0 cm 6"



AC.328.15
15,0 cm 6"
1:2 Teeth



AC.329.15
15,0 cm 6"
1:2 Teeth

Artery Forceps

ARTERIENKLEMMEN - PINZAS HEMOSTÁTICAS

Kolpen

GENERAL INSTRUMENTS
ALLGEMEINES INSTRUMENTARIUM
INSTRUMENTAL GENERAL

AC

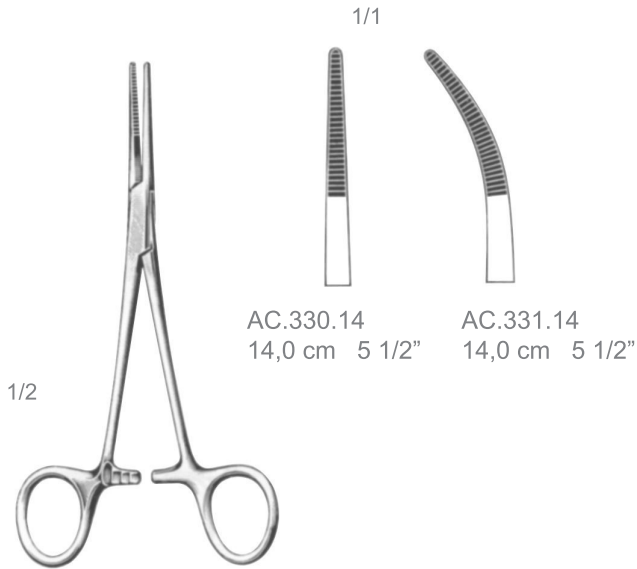

AC.330.14
14,0 cm 5 1/2"

AC.331.14
14,0 cm 5 1/2"

AC.330.14
AC.331.14
Kelly
Artery Forceps

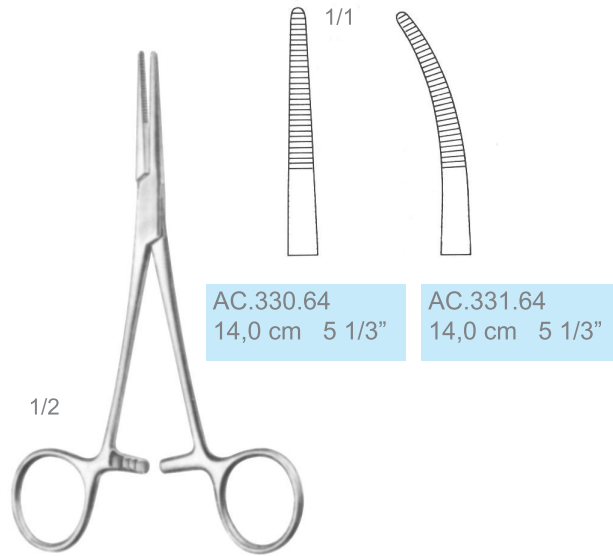

AC.330.64
14,0 cm 5 1/3"

AC.331.64
14,0 cm 5 1/3"

AC.330.64
AC.331.64
Kelly
Titanium
Artery Forceps

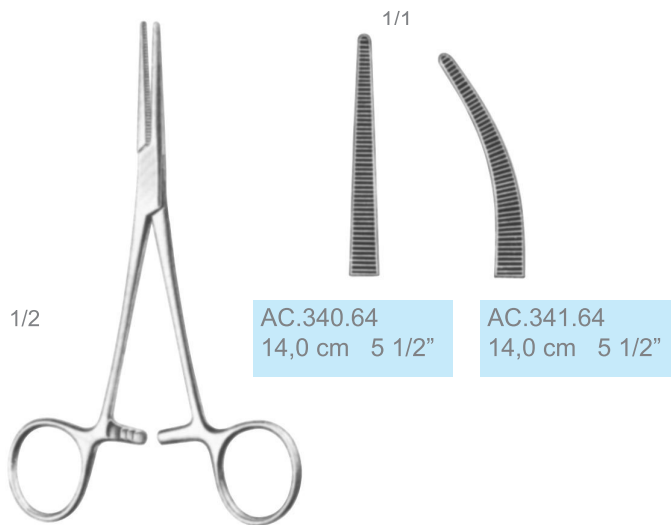

AC.340.64
14,0 cm 5 1/2"

AC.341.64
14,0 cm 5 1/2"

AC.340.64
AC.341.64
Crile
Titanium
Artery Forceps



AC.334.16
16,0 cm 6 1/4"

AC.335.16
16,0 cm 6 1/4"

AC.334.16
AC.335.16
Kelly-Rankin
Artery Forceps

AC

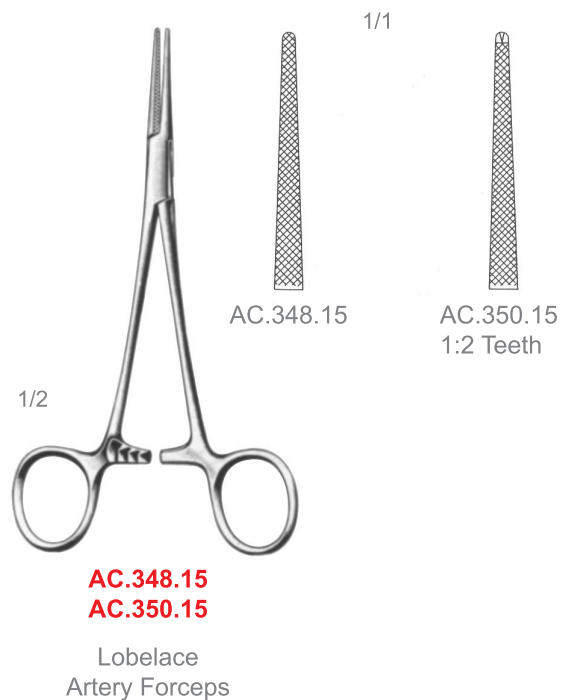
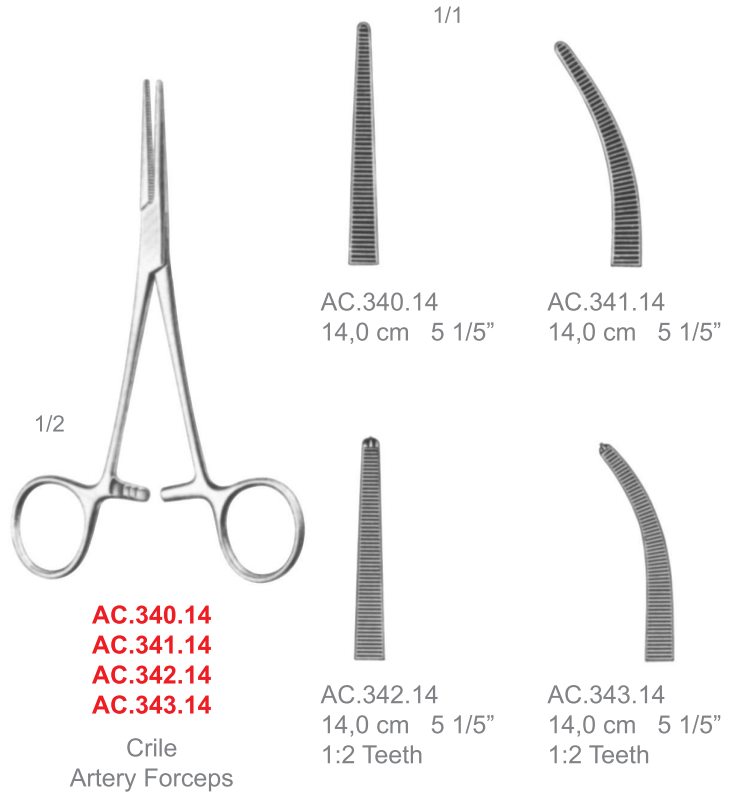

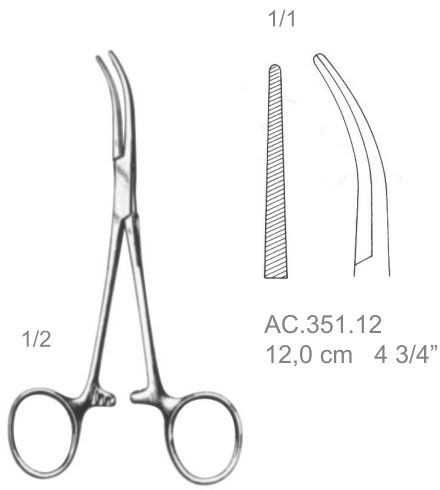

AC.351.12
12,0 cm 4 3/4"

AC.351.12
Mosquito-Dandy
Artery Forceps

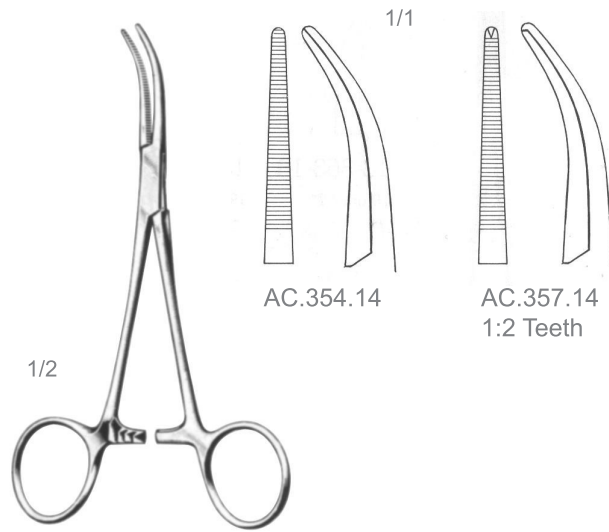

AC.355.14
AC.357.14
1:2 Teeth

AC.355.14
AC.357.14
Dandy
Artery Forceps



AC.358.15 15,0 cm 6"
AC.358.18 18,5 cm 7 1/4"



AC.359.15 15,0 cm 6"
AC.359.18 18,5 cm 7 1/4"

AC.358.15/18
AC.359.15/18
Bainbridge
Artery Forceps

AC



AC.363.18/19
Schindt
Artery Forceps

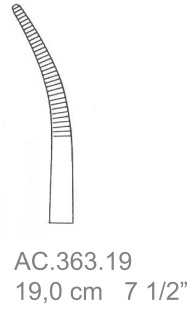
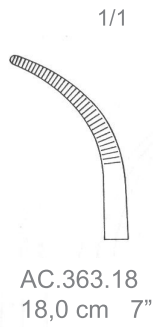

AC.364.18
AC.365.18
Adson
Artery Forceps

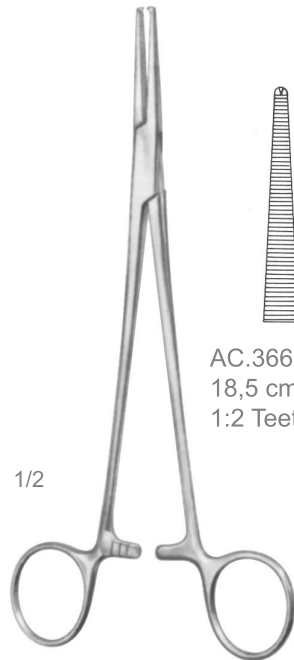
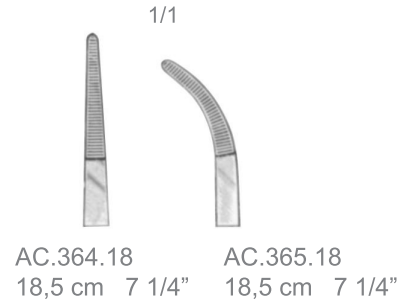

AC.366.18
AC.367.18
Adson
Artery Forceps

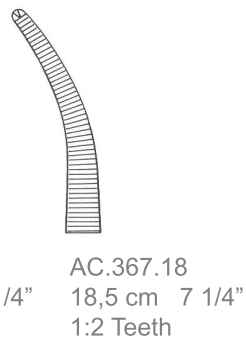
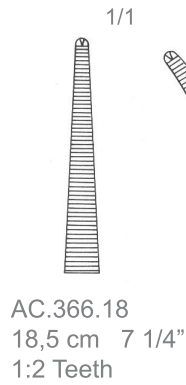



AC.370.16/20
AC.371.16/20

Rochester-Carmalt
Artery Forceps



1/1

AC.370.16 16,0 cm 6 1/4"
AC.370.20 20,0 cm 8"



AC.371.16 16,0 cm 6 1/4"
AC.371.20 20,0 cm 8"



AC.374.13/16
AC.375.13/16

Péan
Artery Forceps
Delicaded Pattern



1/1

AC.374.13 13,0 cm 5"
AC.374.14 14,0 cm 5 1/2"
AC.374.16 16,0 cm 6 1/4"



AC.375.13 13,0 cm 5"
AC.375.14 14,0 cm 5 1/2"
AC.375.16 16,0 cm 6 1/4"

AC



AC.384.13/16

AC.385.13/16

Kocher
Artery Forceps
Delicated Pattern



1/1



AC.384.13 13,0 cm 5"
AC.384.14 14,0 cm 5 1/2"
AC.384.16 16,0 cm 6 1/4"

AC.385.13 13,0 cm 5"
AC.385.14 14,0 cm 5 1/2"
AC.385.16 16,0 cm 6 1/4"



AC.380.14/18

AC.381.14/18

Pean-Nippon
Artery Forceps



1/1

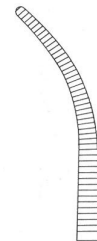

AC.380.14 14,5 cm 5 3/4"
AC.380.16 16,0 cm 6 1/4"
AC.380.18 18,0 cm 7"

AC.381.14 14,5 cm 5 3/4"
AC.381.16 16,0 cm 6 1/4"
AC.381.18 18,0 cm 7"



AC.382.14/18
AC.383.14/18

Kocher-Nippon
Artery Forceps



1/1

AC.382.14 14,5 cm 5 3/4"
AC.382.16 16,0 cm 6 1/4"
AC.382.18 18,0 cm 7"
1:2 Teeth



AC.383.14 14,5 cm 5 3/4"
AC.383.16 16,0 cm 6 1/4"
AC.383.18 18,0 cm 7"
1:2 Teeth



AC.390.20/26
AC.391.20/26
AC.392.20/26
AC.393.20/26

Bengolea
Artery Forceps



AC.390.20 20,0 cm 8"
AC.390.26 26,0 cm 8 1/4"



AC.391.20 20,0 cm 8"
AC.391.26 26,0 cm 10 1/4"



AC.392.20 20,0 cm 8"
AC.392.26 26,0 cm 10 1/4"
1:2 Teeth



AC.393.20 20,0 cm 8"
AC.393.26 26,0 cm 10 1/4"
1:2 Teeth

AC



AC.410.14/30

AC.411.14/30

Péan (Rochester)
Artery Forceps



AC.410.14	14,0 cm	5 1/2"
AC.410.16	16,0 cm	6 1/4"
AC.410.18	18,0 cm	7"
AC.410.20	20,0 cm	8"
AC.410.22	22,0 cm	8 3/4"
AC.410.24	24,0 cm	9 1/2"
AC.410.26	26,0 cm	10 1/4"
AC.410.30	30,0 cm	12"



AC.411.14	14,0 cm	5 1/2"
AC.411.16	16,0 cm	6 1/4"
AC.411.18	18,0 cm	7"
AC.411.20	20,0 cm	8"
AC.411.22	22,0 cm	8 3/4"
AC.411.24	24,0 cm	9 1/2"
AC.411.26	26,0 cm	10 1/4"
AC.411.30	30,0 cm	12"

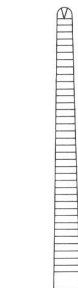

AC.414.14	14,0 cm	5 1/2"
AC.414.16	16,0 cm	6 1/4"
AC.414.18	18,0 cm	7"
AC.414.20	20,0 cm	8"
AC.414.22	22,0 cm	8 3/4"
AC.414.24	24,0 cm	9 1/2"
AC.414.26	26,0 cm	10 1/4"
AC.414.30	30,0 cm	12"
1:2 Teeth		

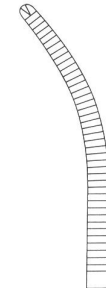

AC.415.14	14,0 cm	5 1/2"
AC.415.16	16,0 cm	6 1/4"
AC.415.18	18,0 cm	7"
AC.415.20	20,0 cm	8"
AC.415.22	22,0 cm	8 3/4"
AC.415.24	24,0 cm	9 1/2"
AC.415.26	26,0 cm	10 1/4"
AC.415.30	30,0 cm	12"
1:2 Teeth		

AC.414.14/30

AC.415.14/30

Kocher (Ochsner)
Artery Forceps

Dissecting and Ligature Forceps

PRÄPARIER- UND LIGATURKLEMMEN - PINZAS PARA PREPARACIONES
Y LIGADURAS

Kolpen

GENERAL INSTRUMENTS
ALLGEMEINES INSTRUMENTARIUM
INSTRUMENTAL GENERAL

AC



AC.417.01	18,5 cm	7 1/2"
AC.417.02	20,5 cm	8"
AC.417.03	21,0 cm	8 1/2"
AC.417.04	21,5 cm	9 1/2"
AC.417.05	24,0 cm	9 1/2"

AC.417.01/05

Martin-Overholt
Dissecting and
ligature forceps

AC

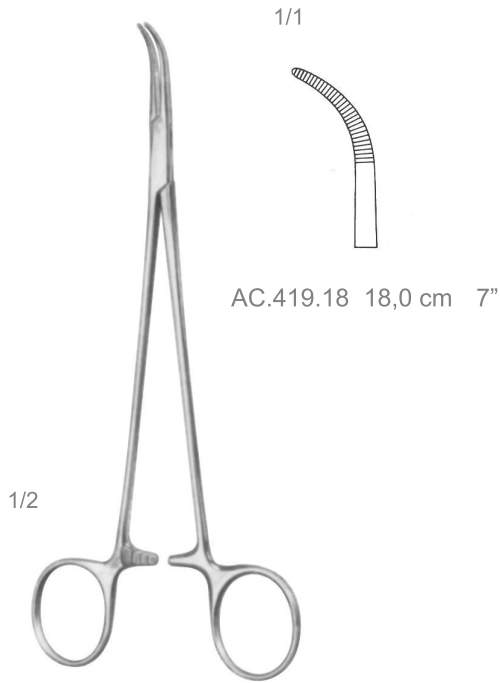

AC.419.18 18,0 cm 7"

AC.419.18

Baby-Mixer
Artery Forceps, Dissecting and
ligature forceps

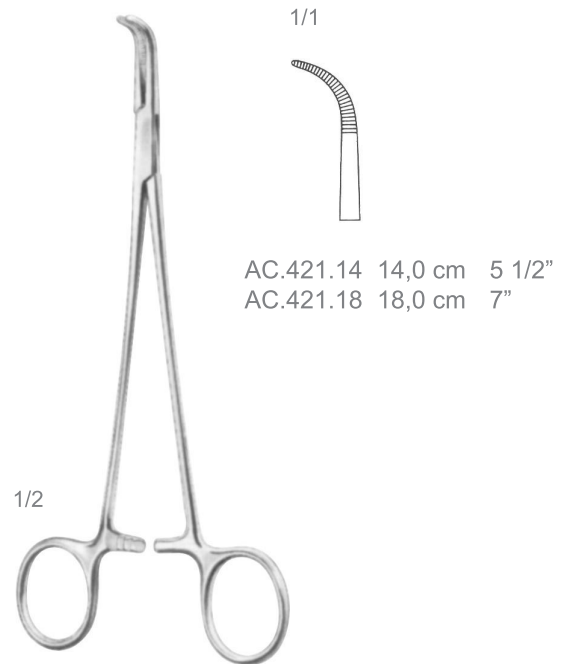

AC.421.14 14,0 cm 5 1/2"
AC.421.18 18,0 cm 7"

AC.421.14/18

Baby-Mixer
Artery Forceps, Dissecting and
ligature forceps

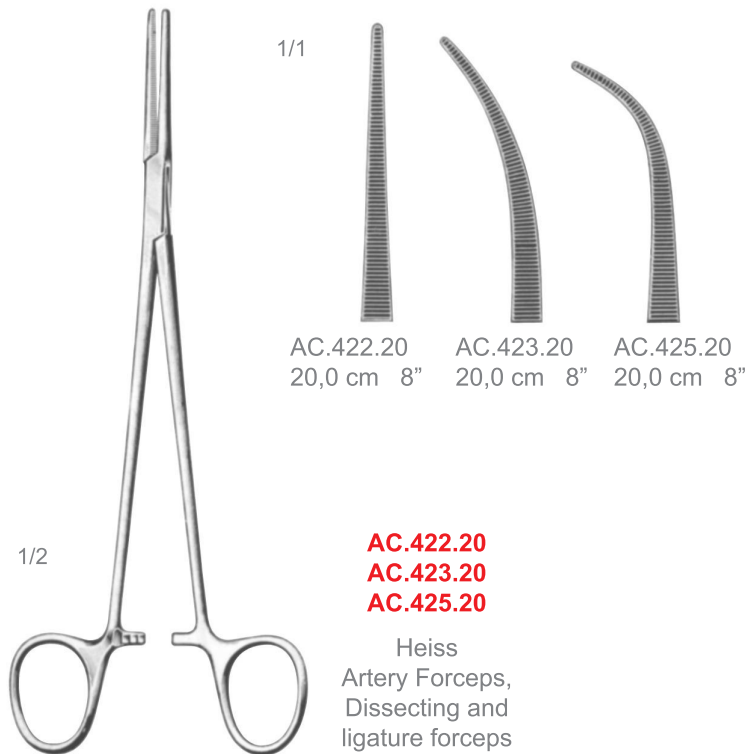

AC.422.20 20,0 cm 8"
AC.423.20 20,0 cm 8"
AC.425.20 20,0 cm 8"

AC.422.20
AC.423.20
AC.425.20

Heiss
Artery Forceps,
Dissecting and
ligature forceps

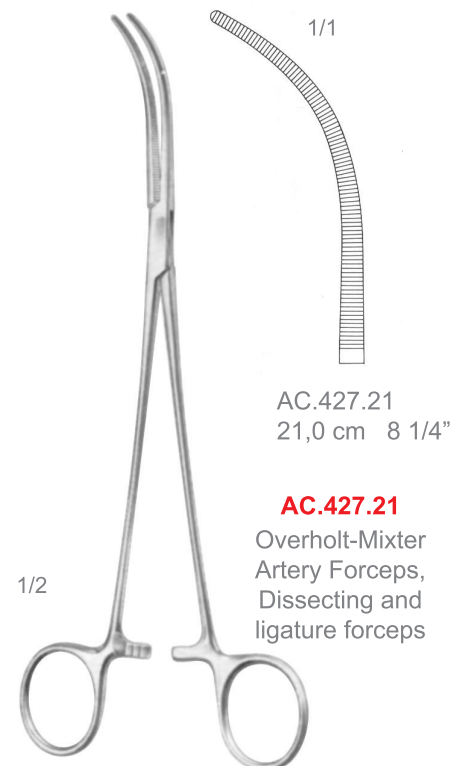

AC.427.21
21,0 cm 8 1/4"

AC.427.21

Overholt-Mixer
Artery Forceps,
Dissecting and
ligature forceps

Artery Forceps, Dissecting and Ligature Forceps

ARTERIENKLEMMEN, PRÄPARIER- UND LIGATURKLEMMEN -
PINZAS HEMOSTÁTICAS, PINZAS PARA PREPARACIONES Y LIGADURAS

Kolpen

GENERAL INSTRUMENTS
ALLGEMEINES INSTRUMENTARIUM
INSTRUMENTAL GENERAL

AC

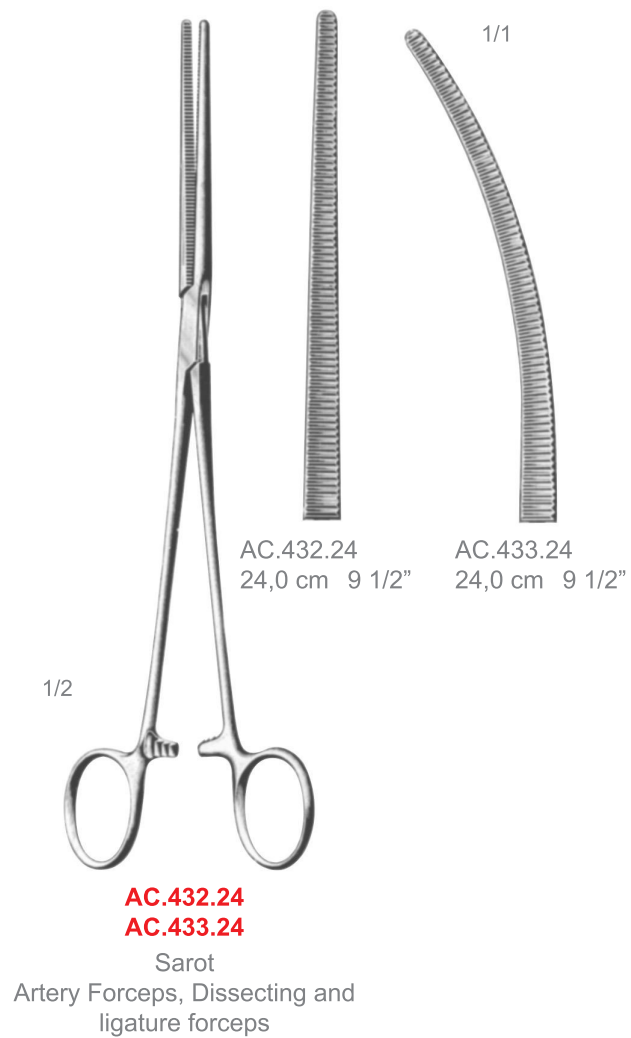
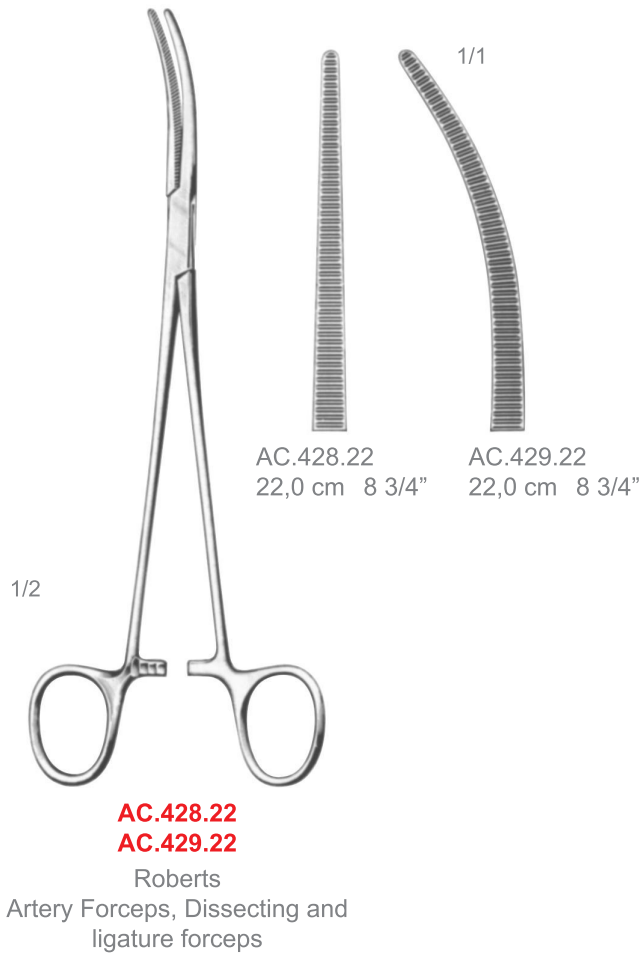

Kolpen

GENERAL INSTRUMENTS
ALLGEMEINES INSTRUMENTARIUM
INSTRUMENTAL GENERAL

Artery Forceps, Dissecting and Ligature Forceps

ARTERIENKLEMMEN, PRÄPARIER- UND LIGATURKLEMMEN -
PINZAS HEMOSTÁTICAS, PINZAS PARA PREPARACIONES Y LIGADURAS

AC



AC.439.18/24

Crafoord
Artery Forceps, Dissecting and
ligature forceps

1/1



AC.439.18 18,0 cm 7"
AC.439.24 24,0 cm 9 1/2"

1/1

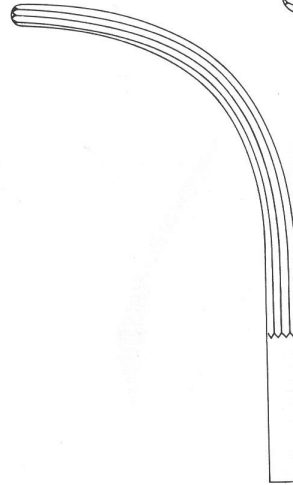

AC.441.22
24,0 cm 9 1/2"

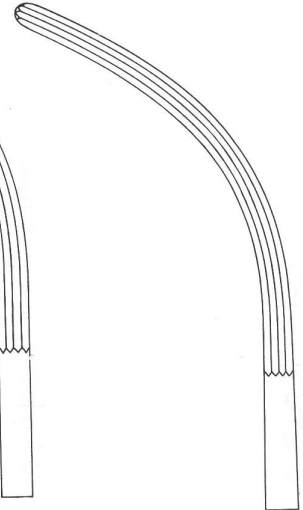

AC.441.23
24,0 cm 9 1/2"



AC.441.22/24

Crafoord-Sellors
Artery Forceps, Dissecting and
ligature forceps

1/2

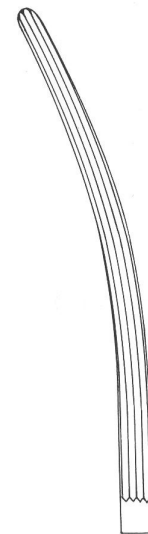

AC.441.24
24,0 cm 9 1/2"

Artery Forceps, Dissecting and Ligature Forceps

ARTERIENKLEMMEN, PRÄPARIER- UND LIGATURKLEMMEN -
 PINZAS HEMOSTÁTICAS, PINZAS PARA PREPARACIONES Y LIGADURAS

Kolpen

GENERAL INSTRUMENTS
 ALLGEMEINES INSTRUMENTARIUM
 INSTRUMENTAL GENERAL

AC



AC.443.01/07
AC.447.01/07

Overholt-Geissendoerfer
 Artery Forceps, Dissecting and
 ligature forceps

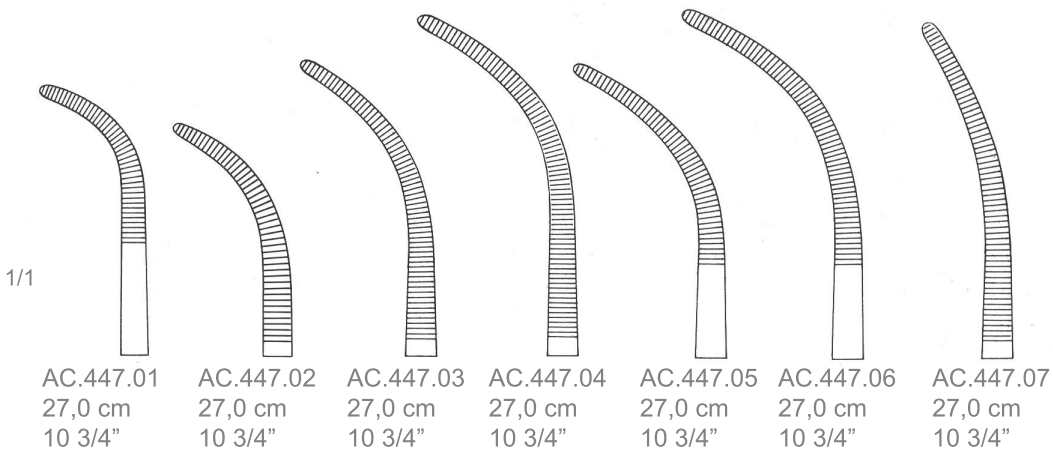
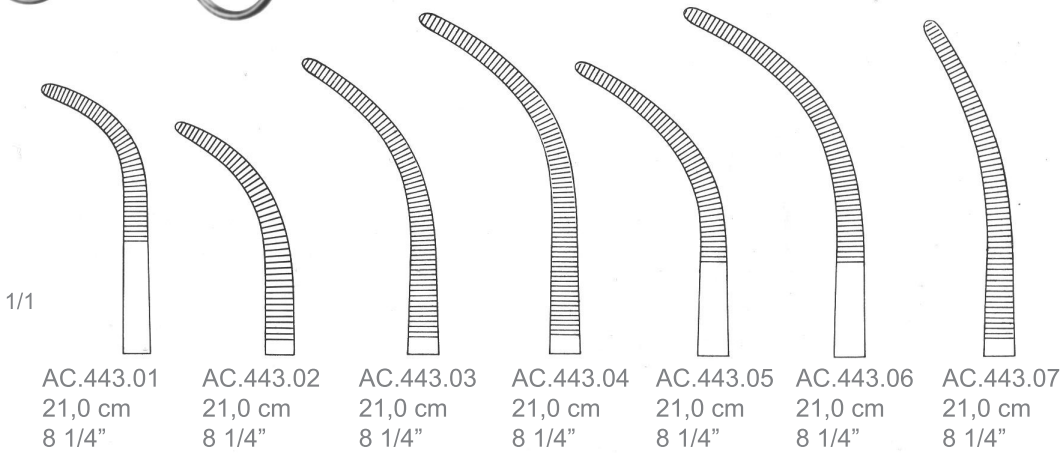

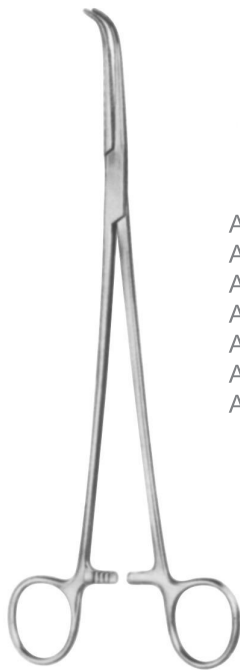

1/1

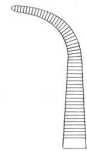

AC.451.13	13,0 cm	5"
AC.451.16	16,0 cm	6 1/4"
AC.451.18	18,0 cm	7"
AC.451.20	20,0 cm	8"
AC.451.23	23,0 cm	9"
AC.451.25	25,0 cm	10"
AC.451.28	28,0 cm	11"

AC.451.13/28

Gemini
Dissecting and
ligature forceps



1/1

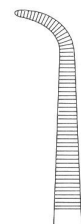

AC.453.18	18,0 cm	7"
AC.453.22	22,0 cm	8 3/4"
AC.453.25	25,0 cm	10"
AC.453.28	28,0 cm	11"

AC.453.18/28

Mini-Gemini
Dissecting and
ligature forceps

Artery Forceps, Dissecting and Ligature Forceps

ARTERIENKLEMMEN, PRÄPARIER- UND LIGATURKLEMMEN -
PINZAS HEMOSTÁTICAS, PINZAS PARA PREPARACIONES Y LIGADURAS

Kolpen

GENERAL INSTRUMENTS
ALLGEMEINES INSTRUMENTARIUM
INSTRUMENTAL GENERAL

AC



AC.461.01/05
Rumel
Artery Forceps,
Dissecting and
ligature forceps

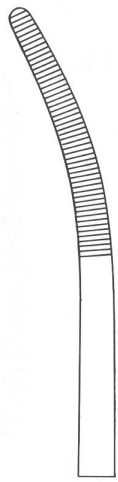

AC.461.01
23,0 cm
9"



AC.461.02
23,0 cm
9"

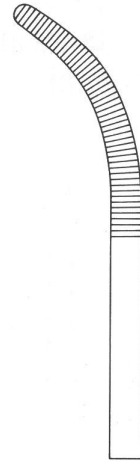

AC.461.03
23,0 cm
9"

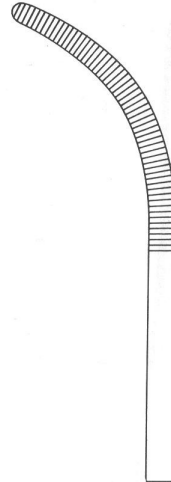

AC.461.04
23,0 cm
9"

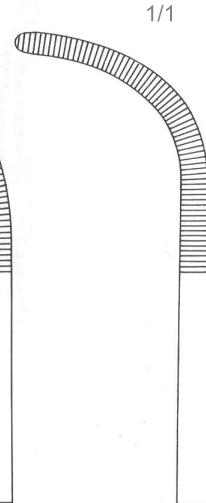

AC.461.05
23,0 cm
9"



AC.462.21
21,0 cm 8 1/4"

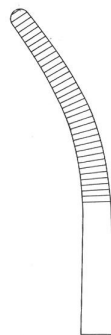

AC.463.21
21,0 cm 8 1/4"



AC.464.21
21,0 cm 8 1/4"



AC.465.21
21,0 cm 8 1/4"

AC.462.26
26,0 cm 10 1/4"

AC.463.26
26,0 cm 10 1/4"

AC.464.26
26,0 cm 10 1/4"

AC.465.26
26,0 cm 10 1/4"

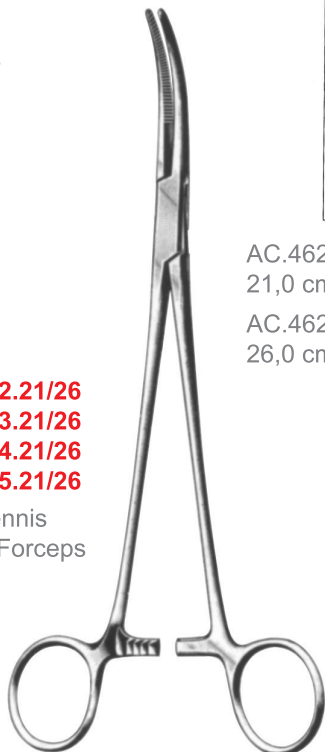

AC.462.21/26
AC.463.21/26
AC.464.21/26
AC.465.21/26
Toennis
Artery Forceps

AC

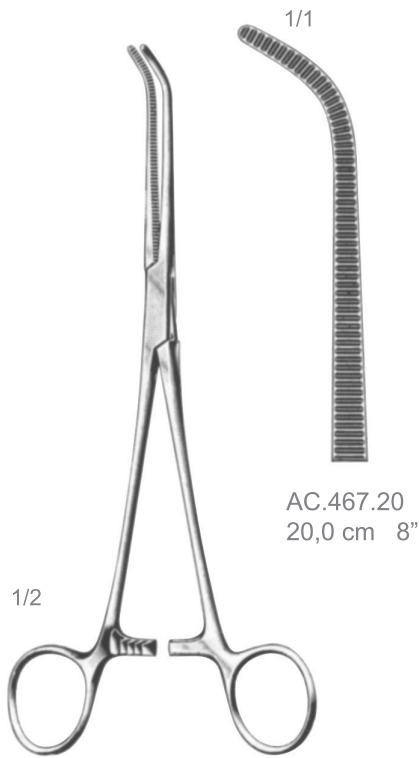

AC.467.20
20,0 cm 8"

AC.467.20

Johns Hopkins
Artery Forceps,
Dissecting and
ligature forceps



AC.471.14
14,0 cm 5 1/2"

AC.471.14

Mixer Baby
Artery Forceps,
Dissecting and
ligature forceps



AC.469.01
29,5 cm 11 1/2"

AC.469.02
29,5 cm 11 1/2"

AC.469.01/02

Zenker
Artery Forceps,
Dissecting and
ligature forceps

Artery Forceps, Bronchus and Gall Duct Clamps

ARTERIEN- UND BRONCHUSKLEMMEN, GALLENKANALKLEMMEN -
PINZAS HEMOSTÁTICAS, PINZAS-CLAMPS PARA BRONQUIOS Y
CONDUCTO BILIAR

Kolpen

GENERAL INSTRUMENTS
ALLGEMEINES INSTRUMENTARIUM
INSTRUMENTAL GENERAL

AC



1/1

AC.473.15 15,5 cm 6"
AC.473.19 19,0 cm 7 1/2"

AC.473.15/19
Mixer
Artery Forceps,
Bronchus and Gall
Duct Clamps



1/1

AC.479.19 19,0 cm 7 1/2"

1/2

AC.479.19
Mixer-O'Shaughnessy
Artery Forceps,
Bronchus and Gall Duct Clamps

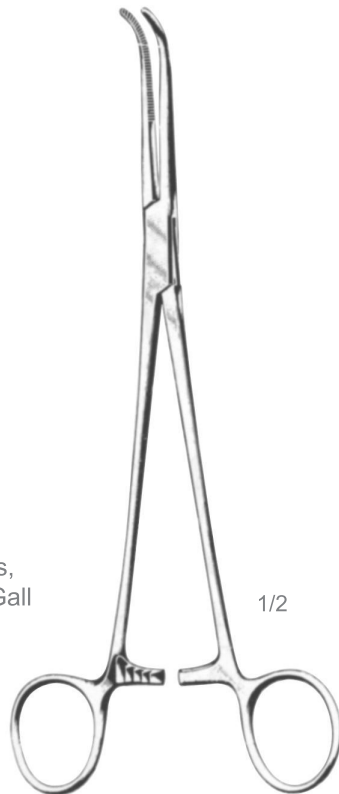

1/1

AC.483.22 22,0 cm 8 3/4"

AC.483.22
Mixer
Artery Forceps,
Bronchus and Gall
Duct Clamps

1/2

Kolpen

GENERAL INSTRUMENTS
ALLGEMEINES INSTRUMENTARIUM
INSTRUMENTAL GENERAL

Artery Forceps, Bronchus and Gall Duct Clamps

ARTERIEN- UND BRONCHUSKLEMMEN, GALLENKANALKLEMMEN -
PINZAS HEMOSTÁTICAS, PINZAS-CLAMPS PARA BRONQUIOS Y
CONDUCTO BILIAR

AC



AC.485.22 23,0 cm 9"

AC.485.23
Mixer
Artery Forceps,
Bronchus and Gall
Duct Clamps

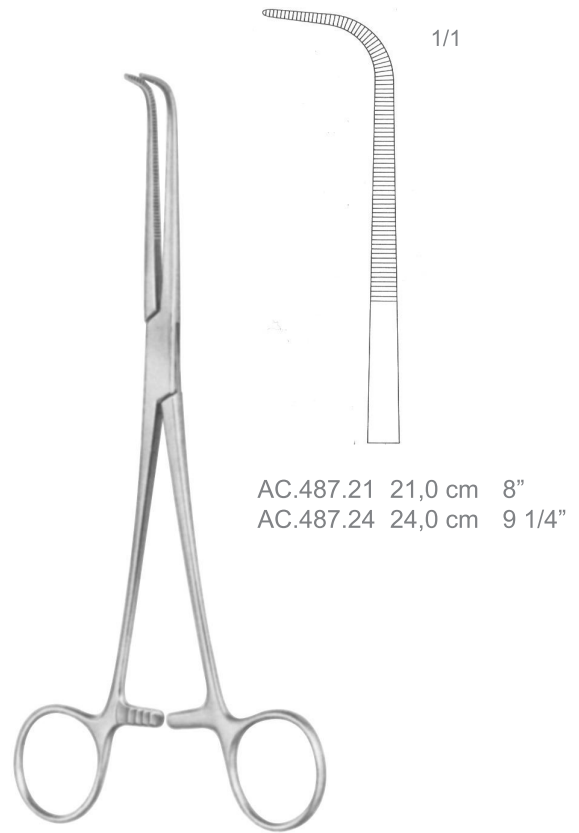

AC.487.21 21,0 cm 8"
AC.487.24 24,0 cm 9 1/4"

AC.487.21/24
Wickström
Artery Forceps,
Bronchus and Gall
Duct Clamps



AC.491.22
AC.493.25
AC.495.28
Mixer
Artery Forceps,
Bronchus and Gall
Duct Clamps

AC.491.22
22,0 cm
8 3/4"

AC.493.25
25,0 cm
10"

AC.495.28
28,0 cm
11"

Artery Forceps, Bronchus and Gall Duct Clamps

ARTERIEN- UND BRONCHUSKLEMMEN, GALLENKANALKLEMMEN -
PINZAS HEMOSTÁTICAS, PINZAS-CLAMPS PARA BRONQUIOS Y
CONDUCTO BILIAR

Kolpen

GENERAL INSTRUMENTS
ALLGEMEINES INSTRUMENTARIUM
INSTRUMENTAL GENERAL

AC



AC.497.22
McQuigg-Mixter
Artery Forceps,
Bronchus and Gall
Duct Clamps

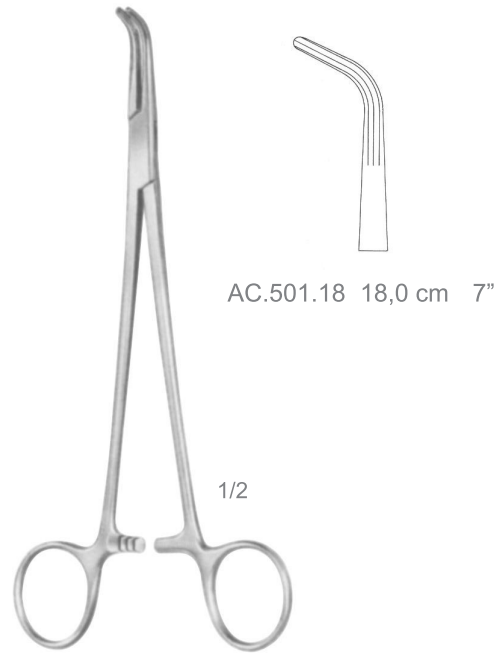

AC.501.18
Lower
Artery Forceps,
Bronchus and Gall
Duct Clamps

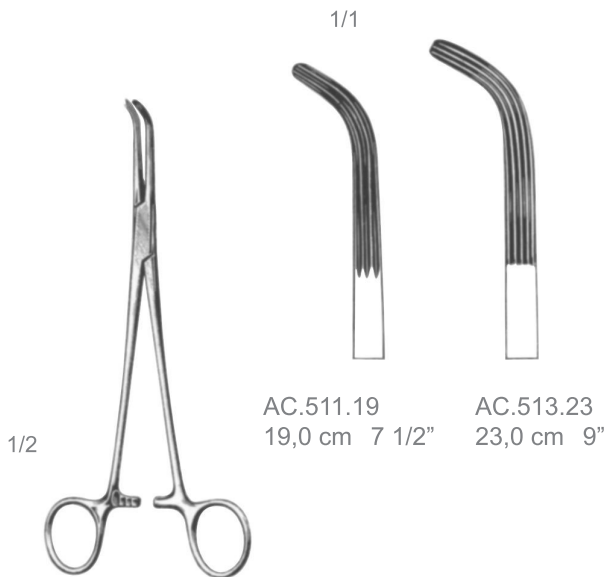

AC.511.19
AC.513.23
Lahey
Artery Forceps,
Bronchus and Gall
Duct Clamps



AC.521.24
Finocchietto
Artery Forceps,
Bronchus and Gall
Duct Clamps

AC



AC.527.01 26,0 cm 10 1/4"
AC.527.02 26,0 cm 10 1/4"

AC.527.01/02
Uro-Tangential
Atrauma
Tangential Forceps

Kidney Pedicle Clamp Forceps

NIERENSTIELKLEMMEN - PINZAS-CLAMPS PARA PEDÚNCULOS RENALES

Kolpen

GENERAL INSTRUMENTS
ALLGEMEINES INSTRUMENTARIUM
INSTRUMENTAL GENERAL

AC



AC.529.23/24

Guyon
Atrauma
Kidney Pedicle
Clamp Forceps



AC.529.23 23,0 cm 9"
AC.529.24 24,0 cm 9 1/2"



AC.531.20/24

Guyon
Kidney Pedicle
Clamp Forceps

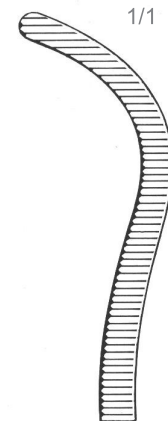

AC.531.20 20,0 cm 8"
AC.531.22 22,0 cm 8 3/4"
AC.531.24 24,0 cm 9 3/4"

AC



AC.533.23
Guyon
Kidney Pedicle
Clamp Forceps

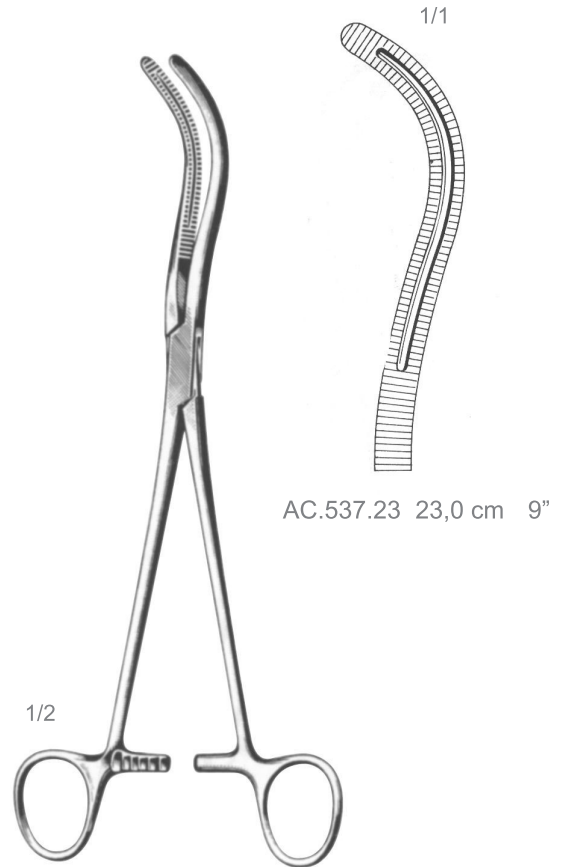

AC.537.23
Stille
Kidney Pedicle
Clamp Forceps



AC.549.23
Herrick
Kidney Pedicle
Clamp Forceps

Gall Duct Clamps

GALLENKANALKLEMMEN - PINZAS PARA CONDUCTO BILIAR

Kolpen

GENERAL INSTRUMENTS
ALLGEMEINES INSTRUMENTARIUM
INSTRUMENTAL GENERAL

AC



AC.561.22
AC.563.23
Gray
Gall Duct Clamps

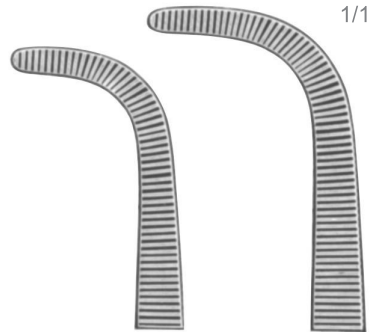

AC.561.22
22,0 cm 8 3/4"

AC.563.23
23,0 cm 9"



AC.571.21
Desjardins
Gall Duct Clamps



AC.571.21
21,0 cm 8 1/4"

AC



AC.577.19/24
AC.579.19/24
AC.581.19/24

Kelly
Artery Forceps,
Dissecting and Ligature
Forceps

1/1



AC.577.19	19,0 cm	7 1/2"	AC.579.19	19,0 cm	7 1/2"	AC.581.19	19,0 cm	7 1/2"
AC.577.22	22,0 cm	8 3/4"	AC.579.22	22,0 cm	8 3/4"	AC.581.22	22,0 cm	8 3/4"
AC.577.24	24,0 cm	9"	AC.579.24	24,0 cm	9 1/2"	AC.581.24	24,0 cm	9 1/2"



AC.583.28
Lawrence
Artery Forceps,
Dissecting and Ligature
Forceps

1/1

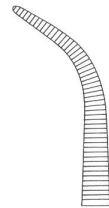

AC.583.28
27,5 cm 10 3/4"

1/2



AC.585.28
Meeker
Artery Forceps,
Dissecting and Ligature
Forceps

1/1

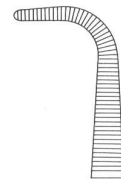

AC.585.28
27,5 cm 10 3/4"

1/2



AC.592.21
21,0 cm 8 1/4"

AC.594.21
21,0 cm 8 1/4"
1:2 Teeth

AC.592.21
AC.594.21
Hosemann
Artery Forceps

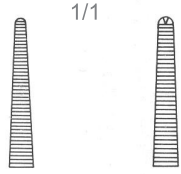

1/1

1/2

1/2



AC.595.19
AC.597.19
Negus
Artery Forceps



1/1

AC.595.19
19,0 cm 7 1/2"

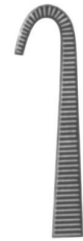

AC.597.19
19,0 cm 7 1/2"

AC



AC.600.21
AC.601.21

Phaneuf
Clamp-Forceps,
Hysterectomy and
Vaginal Forceps



AC.600.21
21,5 cm 8 1/2"
1:2 Teeth

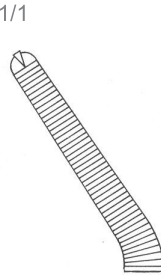

AC.601.21
21,5 cm 8 1/2"
1:2 Teeth

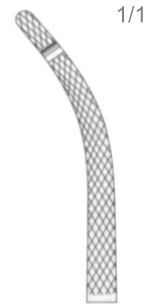

AC.613.19 19,5 cm 7 3/4"
AC.613.21 21,0 cm 8 1/4"
AC.613.23 23,0 cm 9"



AC.613.19/23
AC.615.19/23

Heaney
Clamp-Forceps,
Hysterectomy and
Vaginal Forceps



AC.615.19 19,5 cm 7 3/4"
AC.615.21 21,0 cm 8 1/4"
AC.615.23 23,0 cm 9"

Clamp-Forceps-Hysterectomy and Vaginal Forceps

KLEMMZANGEN, HYSTEREKTOMIEKLEMMEN, VAGINALKLEMMEN
PINZAS-CLAMPS, PINZAS-CLAMPS PARA HISTERECTOMÍA Y VAGINALES

Kolpen

GENERAL INSTRUMENTS
ALLGEMEINES INSTRUMENTARIUM
INSTRUMENTAL GENERAL

AC

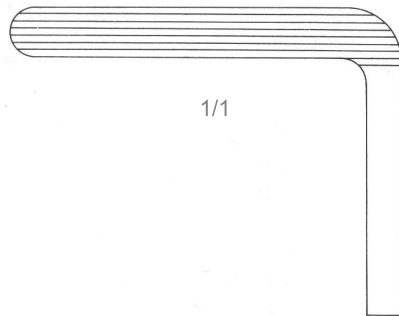

AC.625.21 21,5 cm 8 1/2"

AC.625.21

Wertheim-Cullen
Clamp-Forceps,
Hysterectomy and
Vaginal Forceps

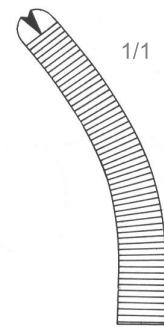

AC.633.24 24 cm 9 1/2"
Extra Strong



AC.633.24

Wertheim
Clamp-Forceps,
Hysterectomy and
Vaginal Forceps

AC



AC.635.10/40
AC.637.10/40

Rogers
Atrauma
Hysterectomy Forceps

1/1

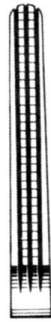

AC.635.10
22,0 cm
8 3/4"



AC.635.20
21,5 cm
8 1/2"



AC.635.30
21,0 cm
8 1/4"

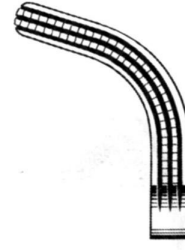

AC.635.40
20,5 cm
8"

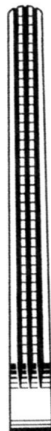

AC.637.10
25,0 cm
10"



AC.637.20
25,0 cm
10"



AC.637.30
24,5 cm
9 3/4"

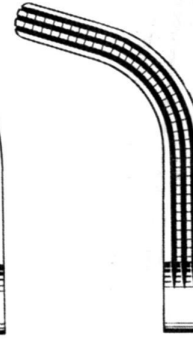

AC.637.40
23,0 cm
9"

Clamps-Forceps, Hysterectomy and Vaginal Forceps

KLEMMZANGEN, HYSTEREKTOMIEKLEMMEN, VAGINALKLEMMEN
PINZAS-CLAMPS, PINZAS-CLAMPS PARA HYSTERECTOMIA Y VAGINALES

Kolpen

GENERAL INSTRUMENTS
ALLGEMEINES INSTRUMENTARIUM
INSTRUMENTAL GENERAL

AC



AC.671.23
AC.673.24
Moynihan
Clamp-Forceps,
Hysterectomy and Vaginal
Forceps

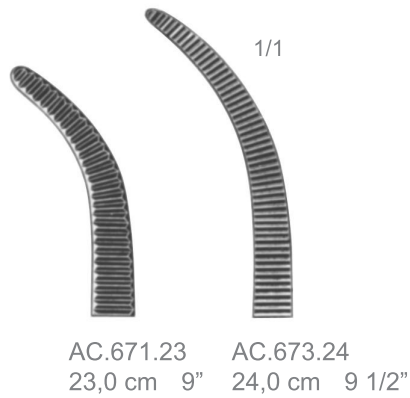

AC.676.24
24,0 cm 9 1/2"

AC.677.24
24,0 cm 9 1/2"

AC.676.24
AC.677.24
Segond-Landau
Clamp-Forceps,
Hysterectomy and Vaginal
Forceps



Kolpen

Clamps-Forceps, Hysterectomy and Vaginal Forceps

GENERAL INSTRUMENTS

KLEMMZANGEN, HYSTEREKTOMIEKLEMMEN, VAGINALKLEMMEN

ALLGEMEINES INSTRUMENTARIUM

PINZAS-CLAMPS, PINZAS-CLAMPS PARA HYSTERECTOMIA Y VAGINALES

INSTRUMENTAL GENERAL

AC



AC.679.25
Faure
Clamp-Forceps,
Hysterectomy and Vaginal
Forceps



AC.679.25
25,0 cm 10"

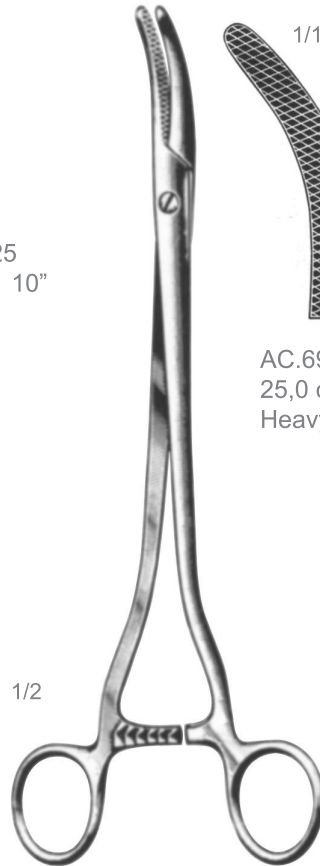

AC.695.25
Wertheim
Clamp-Forceps,
Hysterectomy and Vaginal
Forceps

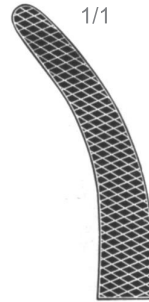

AC.695.25
25,0 cm 10"
Heavy Pattern



AC.697.25
25,0 cm 10"

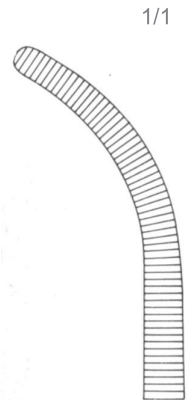

Clamps-Forceps, Hysterectomy and Vaginal Forceps

KLEMMZANGEN, HYSTEREKTOMIEKLEMMEN, VAGINALKLEMMEN
PINZAS-CLAMPS, PINZAS-CLAMPS PARA HYSTERECTOMIA Y VAGINALES

Kolpen

GENERAL INSTRUMENTS
ALLGEMEINES INSTRUMENTARIUM
INSTRUMENTAL GENERAL

AC

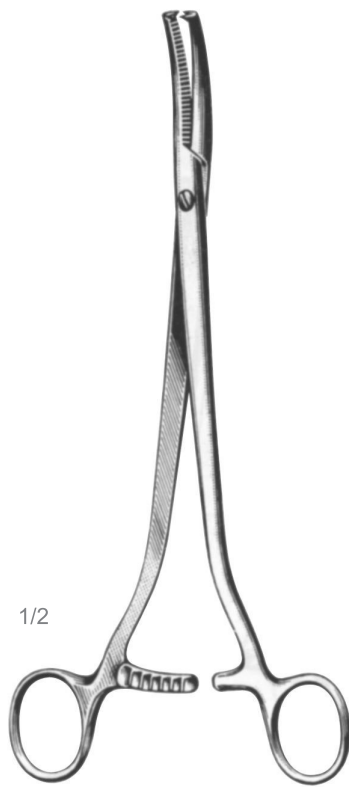

AC.713.22
AC.715.23
Wertheim
Clamp-Forceps,
Hysterectomy and Vaginal
Forceps

1/1



AC.713.22
22,0 cm 8 3/4"
1:2 Teeth
Slightly curved



AC.715.23
23,0 cm 9"
1:2 Teeth
More curved



AC.717.22
AC.719.23
Wertheim
Clamp-Forceps,
Hysterectomy and Vaginal
Forceps

1/1



AC.717.22
22,0 cm 8 3/4"
1:2 Teeth
Slightly curved



AC.719.23
23,0 cm 9"
1:2 Teeth
More curved

AC



AC.721.14
14,0 cm 5 1/2"

AC.721.14
Baby-Mikulicz
Peritoneal Clamp Forceps

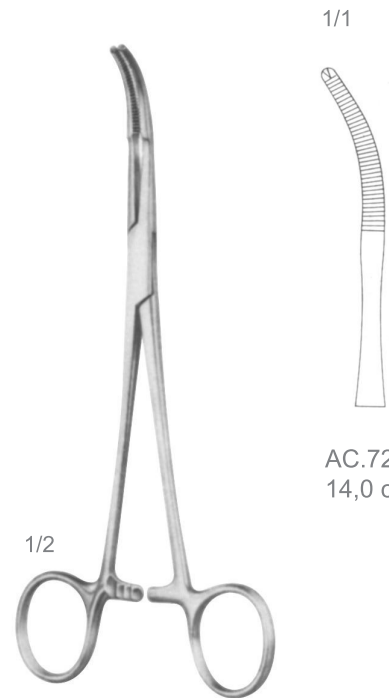

AC.721.14
14,0 cm 5 1/2"

AC.721.14
Mikulicz
Peritoneal Clamp Forceps



AC.727.20
20,0 cm 8"

AC.721.14
Mikulicz
Peritoneal Clamp Forceps

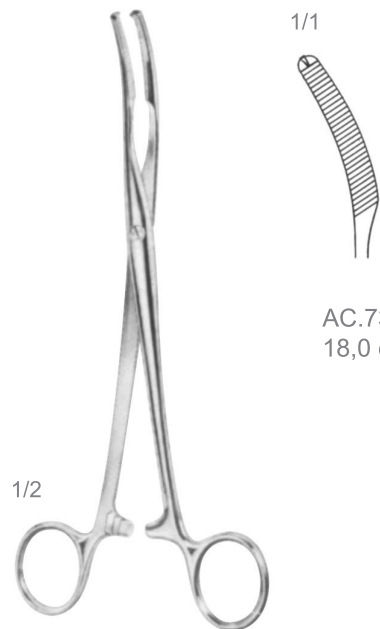

AC.737.18
18,0 cm 7"

AC.737.18
Mikulicz
Peritoneal Clamp Forceps

Peritoneal Clamps Forceps

PERITONEUMKLEMMEN - PINZAS-CLAMPS PARA PERITONEO

Kolpen

GENERAL INSTRUMENTS
ALLGEMEINES INSTRUMENTARIUM
INSTRUMENTAL GENERAL

AC

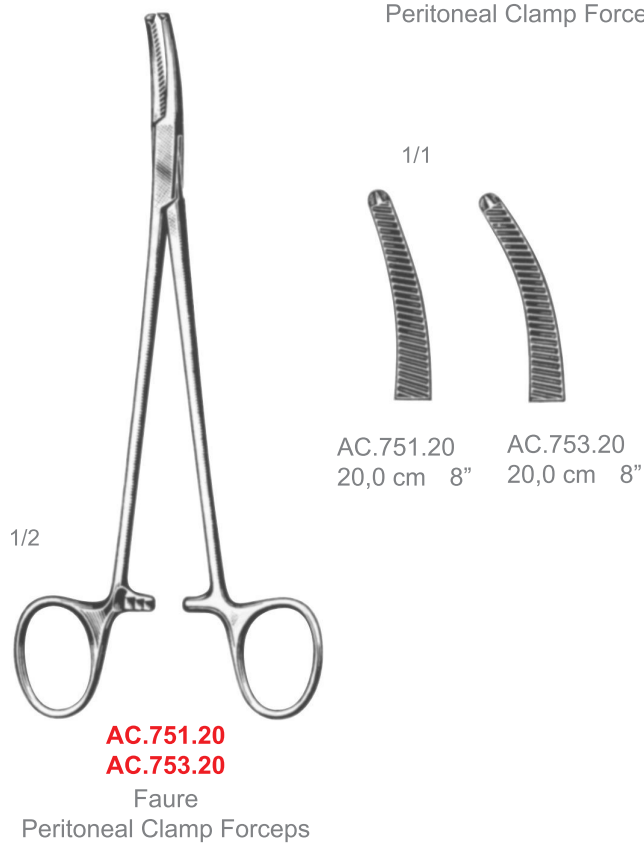
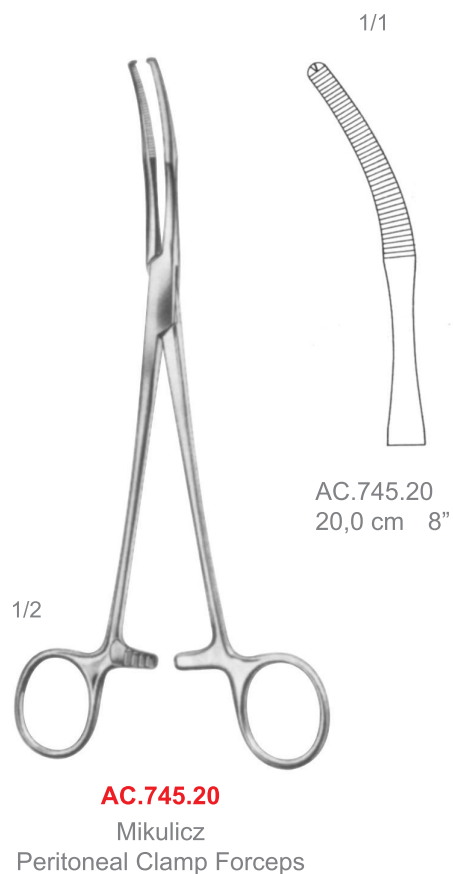
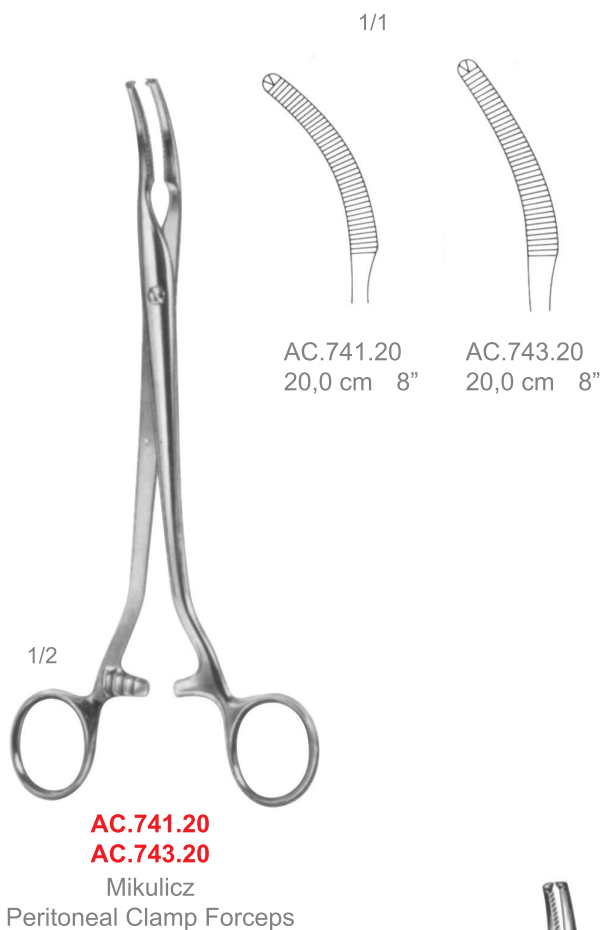

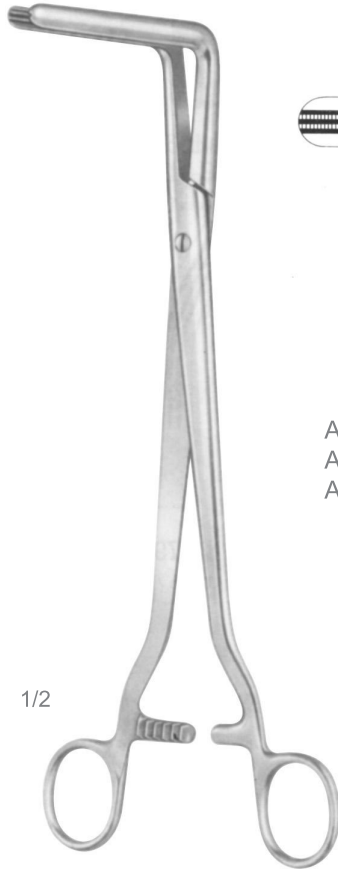

1/2

AC.789.06/10

Wertheim
Atrauma
Clamp-Forceps,
Hysterectomy and Vaginal Forceps

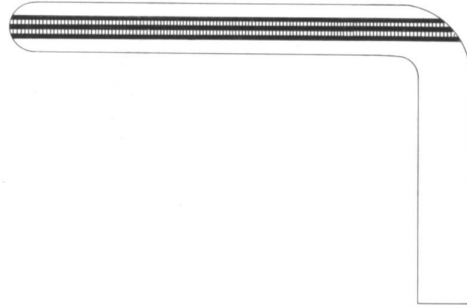

AC.789.06 24,0 cm 9 1/2"
AC.789.08 24,0 cm 9 1/2"
AC.789.10 24,0 cm 9 1/2"

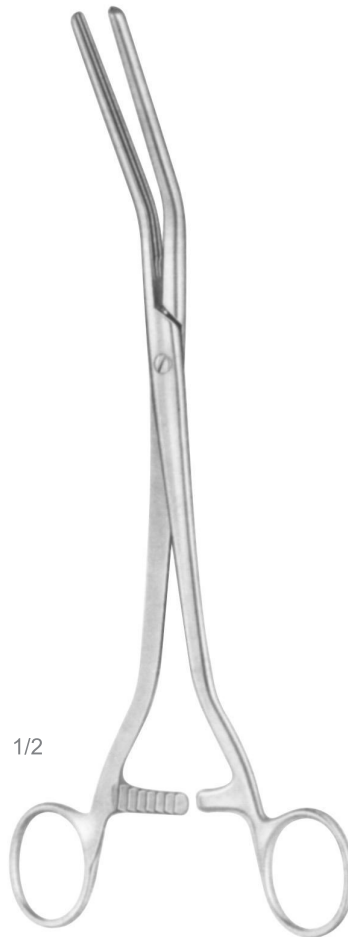

1/2

AC.791.25/27

Dick
Atrauma
Clamp-Forceps,
Hysterectomy and Vaginal Forceps



1/1

AC.791.25 25,0 cm 10"
AC.791.26 26,0 cm 10 1/4"
AC.791.27 27,0 cm 11"

Towel Forceps

TUCHKLEMMEN - PINZAS PARA COMPRESAS, PINZAS DE CAMPO

Kolpen

GENERAL INSTRUMENTS
ALLGEMEINES INSTRUMENTARIUM
INSTRUMENTAL GENERAL

AC



1/2

AC.875.09

AC.875.09 9,0 cm 3 1/2"
Schaedel
Towel Forceps



AC.881.05/09

AC.881.05 5,0 cm 2"
AC.881.09 9,0 cm 3 1/2"
Jones
Towel Forceps



1/2

AC.883.09

AC.883.09 9,0 cm 3 1/2"
With Clip for Tubing or Cable
Jones-Martin
Towel Forceps

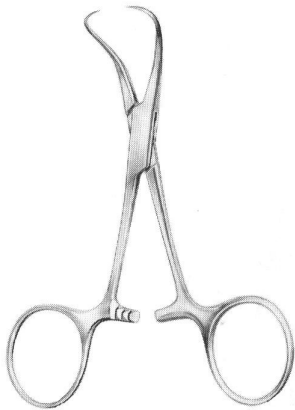

AC.909.11/13

Towel Forceps

AC.909.11 11,0 cm 4 1/2"
AC.909.13 13,0 cm 5"
Delicate Pattern

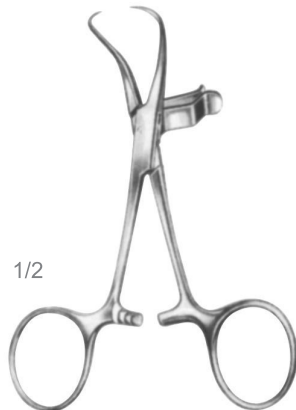

1/2

AC.913.11

Towel Forceps

AC.913.11 11,0 cm 4 1/2"
With Clip for Tubing or Cable



1/1

AC.915.08 8,0 cm 3 1/4"
AC.915.11 11,0 cm 4 1/2"
AC.915.13 13,0 cm 5"
AC.915.15 15,0 cm 6"

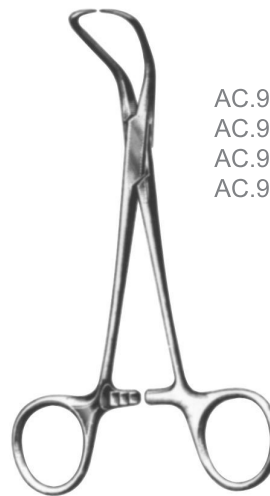

AC.915.08/15

Backhaus
Towel Forceps

AC



AC.917.13 13,0 cm 5"
AC.917.15 15,0 cm 6"

AC.917.13/15

Roeder
Towel Forceps



AC.919.10 10,0 cm 4"
AC.919.13 13,0 cm 5"

AC.919.10/13

Lorna
Towel Forceps



AC.921.16 16,5 cm 6 1/2"

AC.921.16

Bernhard
Towel Forceps



AC.935.20 20,0 cm 8"

AC.935.20

Lane
Towel Forceps

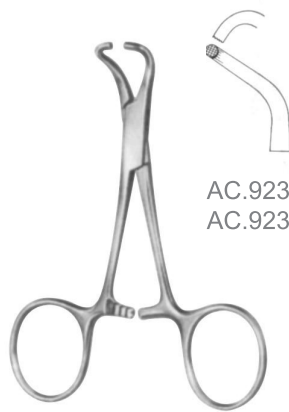

AC.923.10 10,0 cm 4"
AC.923.13 13,0 cm 5"

AC.923.10/13

Tohoku
Towel Forceps

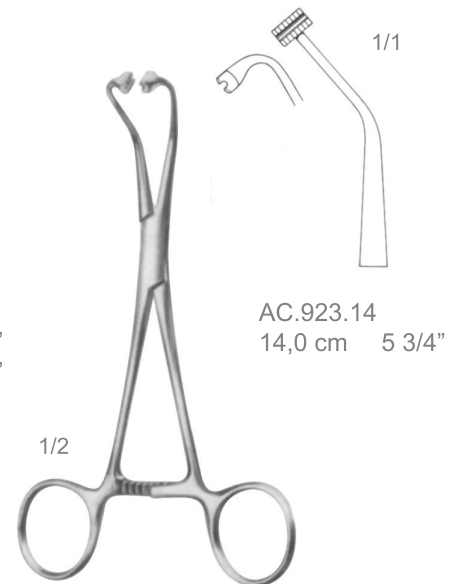

AC.923.14
14,0 cm 5 3/4"

AC.923.14

Peers-Bertram
Towel Forceps



1/2

AC.940.14
Tubing Clamps

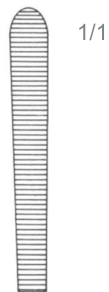

1/1

AC.940.14 14,5 cm 5 3/4"
With extra long ratchet



1/2

AC.942.16
Tubing Clamps

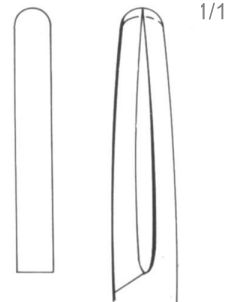

1/1

AC.942.16 16,5 cm 6 1/2"

AC



AC.944.15/20
Standard
Tubing Clamps



1/1

- AC.944.15 15,0 cm 6"
- AC.944.18 18,0 cm 7"
- AC.944.20 20,0 cm 8"



AC.946.15/20
Tubing Clamps

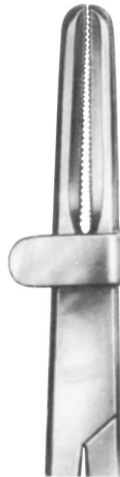

1/1

- AC.946.15 15,0 cm 6"
- AC.946.18 18,0 cm 7"
- AC.946.20 20,0 cm 8"
with safety guard