

# Kolpen

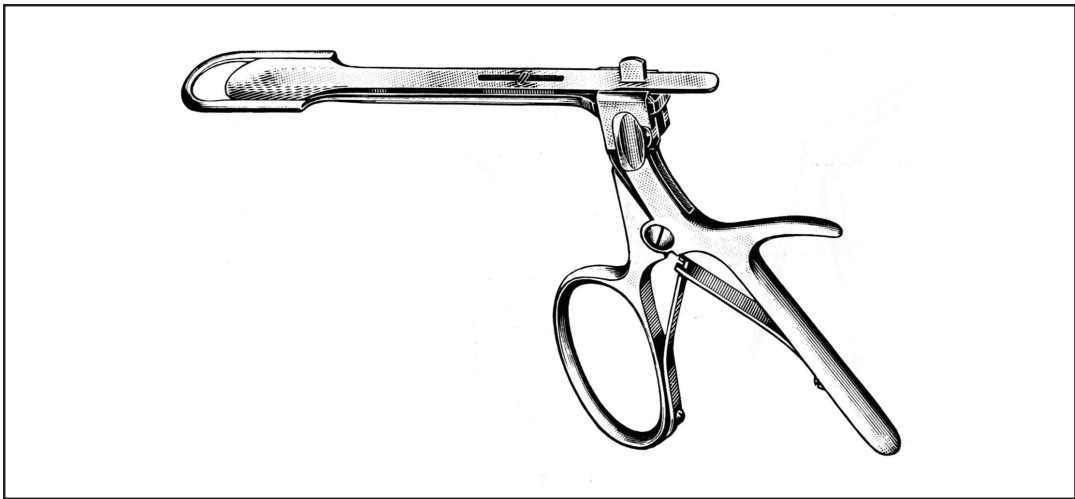

---

CI



CI

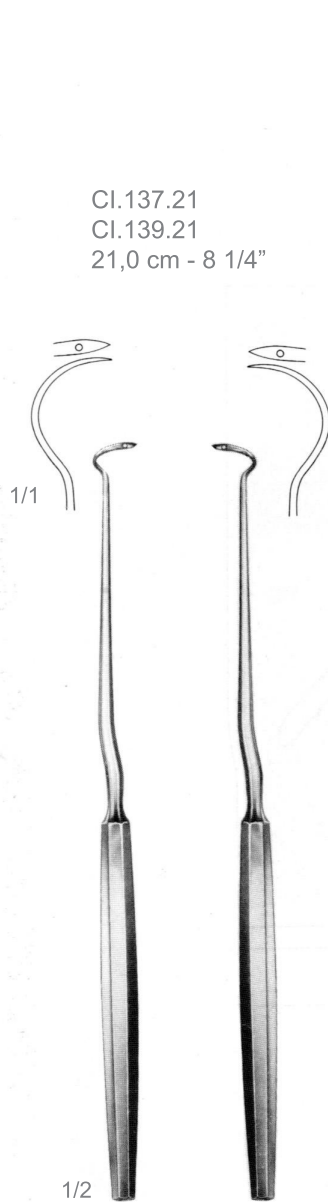

CI.137.21  
CI.139.21  
21,0 cm - 8 1/4"

**CI.137.21**  
**CI.139.21**  
Hurd  
Cleft Palate Needles

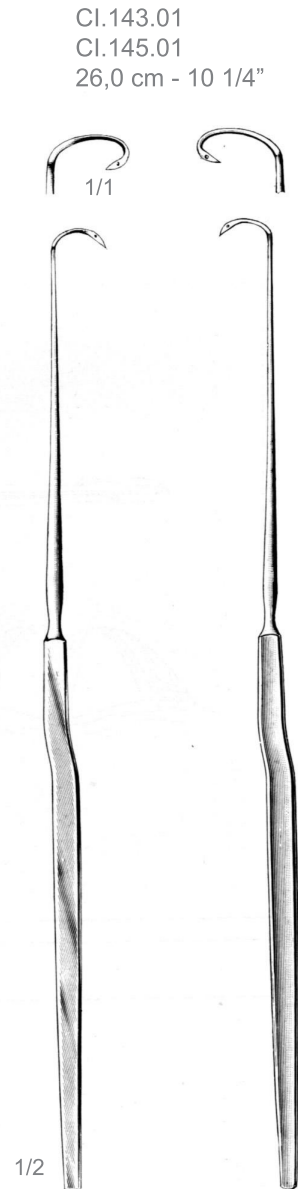

CI.143.01  
CI.145.01  
26,0 cm - 10 1/4"

**CI.143.01**  
**CI.145.01**  
Rotter  
Cleft Palate Needles

CI.171.24  
24,0 cm - 9 1/2"

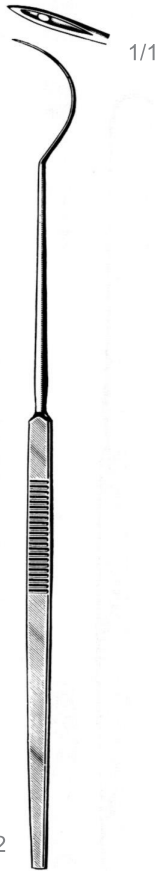

**CI.171.24**  
Nager  
Tonsil Needles

CI.175.22  
CI.177.22  
22,0 cm - 8 3/4"

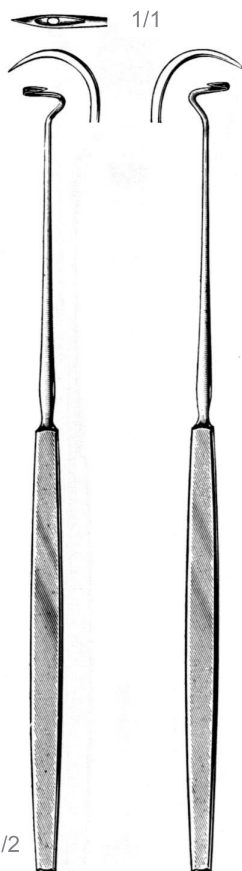

**CI.175.22**  
**CI.177.22**  
Dupuy-Weiss  
Tonsil Needles

CI.177.24  
CI.179.24  
24,0 cm - 9 1/2"

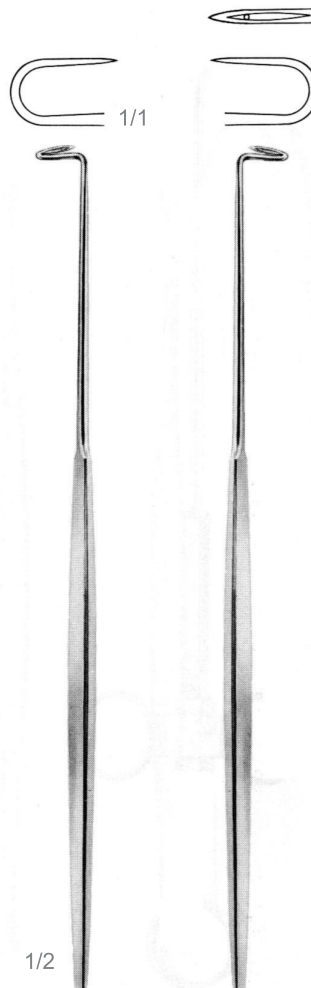

**CI.177.24**  
**CI.179.24**  
Falk  
Tonsil Needles

CI.181.23  
23,0 cm - 9"

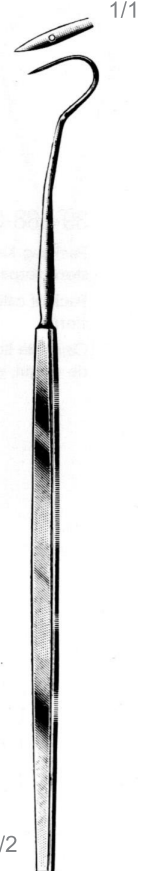

**CI.181.23**  
Claus-Eicken  
Tonsil Needles

CI

CI.188.01  
Pack of catgut ligatures,  
sterile

CI.189.00  
26,5 cm - 10 1/2"

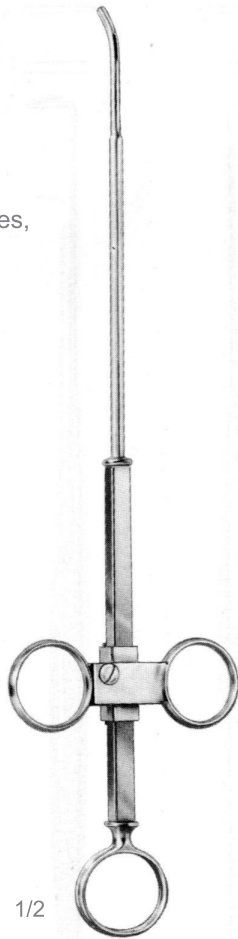

**CI.189.00**  
Röder  
Tonsil Knives,  
Ligature Carrier

CI.219.22  
22,5 cm - 9"



**CI.219.22**  
Fisher  
Tonsil Knives,  
Ligature Carrier

CI.223.21  
21,0 cm - 8 1/4"



**CI.223.21**  
Abraham  
Tonsil Knives,  
Ligature Carrier

CI.227.23  
23,0 cm - 9"



**CI.227.23**  
Bruenings  
Tonsil Knives,  
Ligature Carrier

Tonsil Knives, Dissectors, Enucleator, Retractor etc.

TONSILLENMESSER, DISSEKTOREN, ENUKLEATOR, RETRAKTOR USW. -  
 BISTURIÉS, DISCADORES, ENUCLEADOR, SEPARADOR ETC.

# Kolpen

PALATE, TONSILS  
 GAUMEN, TONSILLEN  
 PALADAR, AMÍGDALAS

CI

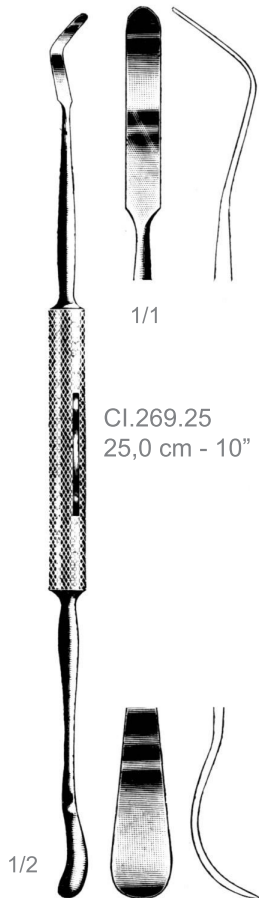

CI.269.25  
 25,0 cm - 10"

1/2

**CI.269.25**  
 Carpenter  
 Tonsil Knives,  
 Dissectors,  
 Enucleator,  
 Retarctor etc.

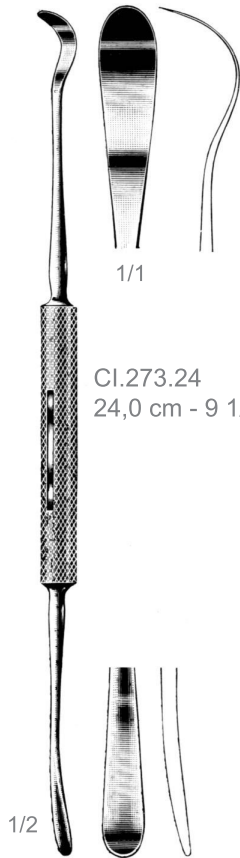

CI.273.24  
 24,0 cm - 9 1/2"

1/2

**CI.273.24**  
 Carpenter  
 Tonsil Knives,  
 Dissectors,  
 Enucleator,  
 Retarctor etc.

CI.281.22  
 22,5 cm - 9"

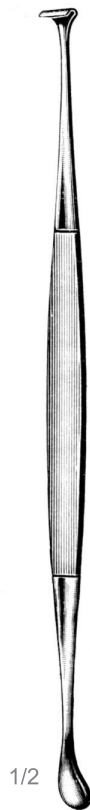

1/2

**CI.281.22**  
 Hurd  
 Tonsil Knives,  
 Dissectors,  
 Enucleator,  
 Retarctor etc.

CI.289.23  
 23,0 cm - 9"

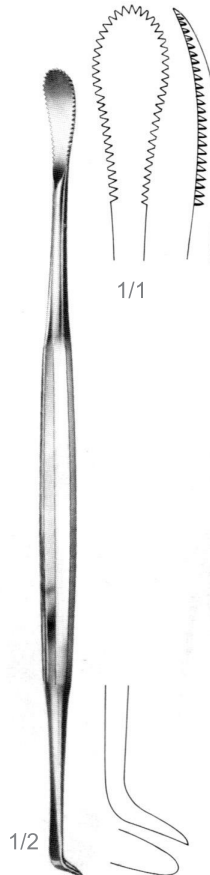

1/2

**CI.289.23**  
 Henke  
 Tonsil Knives,  
 Dissectors,  
 Enucleator,  
 Retarctor etc.

CI.291.23  
 23,0 cm - 9"

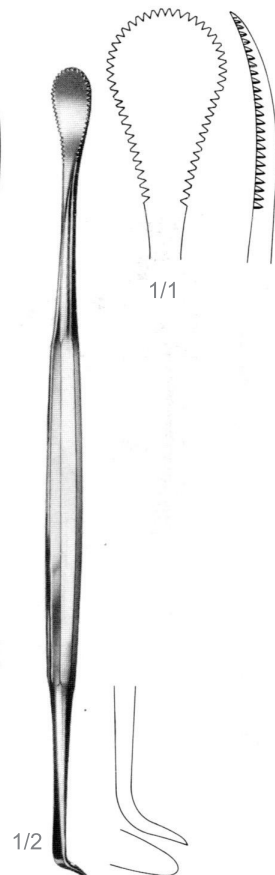

1/2

**CI.291.23**  
 Henke  
 Tonsil Knives,  
 Dissectors,  
 Enucleator,  
 Retarctor etc.

# Kolpen

PALATE, TONSILS  
GAUMEN, TONSILLEN  
PALADAR, AMÍGDALAS

## Tonsil Knives, Dissectors, Enucleator, Retractor etc.

TONSILLENMESSER, DISSEKTOREN, ENUKLEATOR, RETRAKTOR USW. -  
BISTURÍES, DISCADORES, ENUCLEADOR, SEPARADOR ETC.

CI

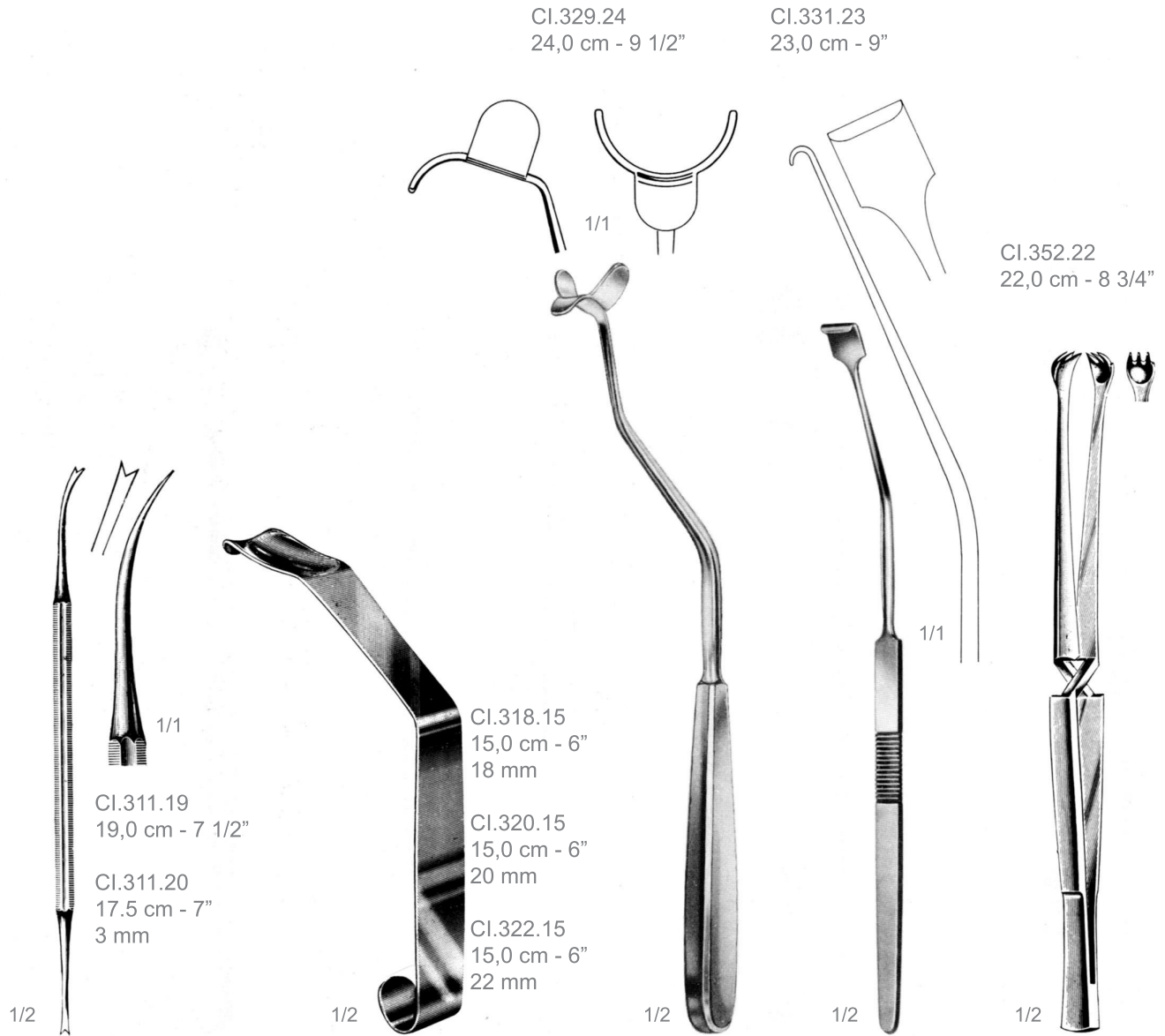

**CI.311.19/20**

Carpenter  
Tonsil Knives,  
Dissectors,  
Enucleator,  
Retractor etc.

**CI.318.15  
CI.320.15  
CI.322.15**

Love  
Tonsil Knives,  
Dissectors,  
Enucleator,  
Retractor etc.

**CI.329.24**

Hofer  
Tonsil Knives,  
Dissectors,  
Enucleator,  
Retractor etc.

**CI.331.23**

Nager  
Tonsil Knives,  
Dissectors,  
Enucleator,  
Retractor etc.

**CI.352.22**

Marschik  
Tonsil Knives,  
Dissectors,  
Enucleator,  
Retractor etc.

# Tonsil Seizing Forceps

TONSILLENZANGEN - PINZAS PARA COGER LAS AMÍGDALAS

# Kolpen

PALATE, TONSILS  
GAUMEN, TONSILLEN  
PALADAR, AMÍGDALAS

CI

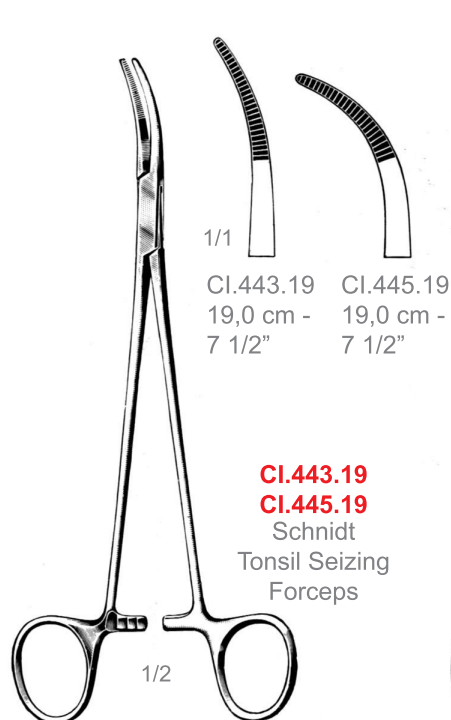
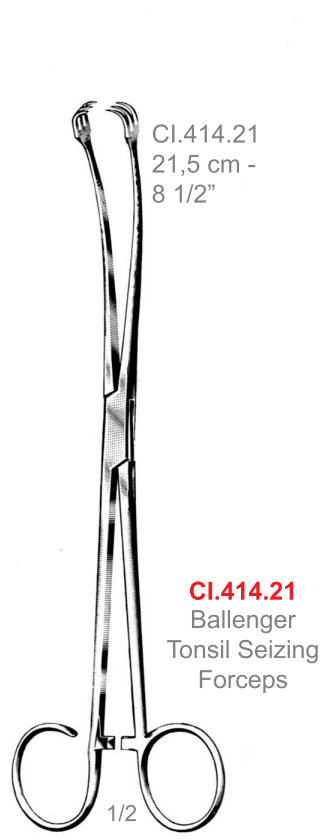



# Kolpen

PALATE, TONSILS  
GAUMEN, TONSILLEN  
PALADAR, AMÍGDALAS

## Tonsil Snares

TONSILLENESCHNÜRER - CIERRA-NUDOS PARA AMÍGDALAS

CI

CI.511.40 40 mm  
CI.511.50 50 mm

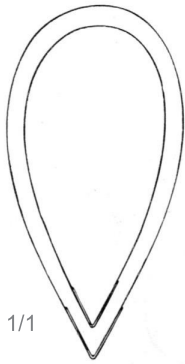

1/1

**CI.511.40/50**  
Tonsil Snares

CI.513.01  
0,3 mm Ø



1/1

**CI.513.01**  
Tonsil Snares

1/1

CI.500.28  
28,0 cm - 11"



1/3

**CI.500.28**  
Eves  
Tonsil Snares

1/1

CI.502.28  
28,0 cm - 11"



1/3

**CI.502.28**  
Eves  
Tonsil Snares

1/1

CI.506.28  
28,0 cm - 11"



1/3

**CI.506.28**  
Bruenings  
Tonsil Snares

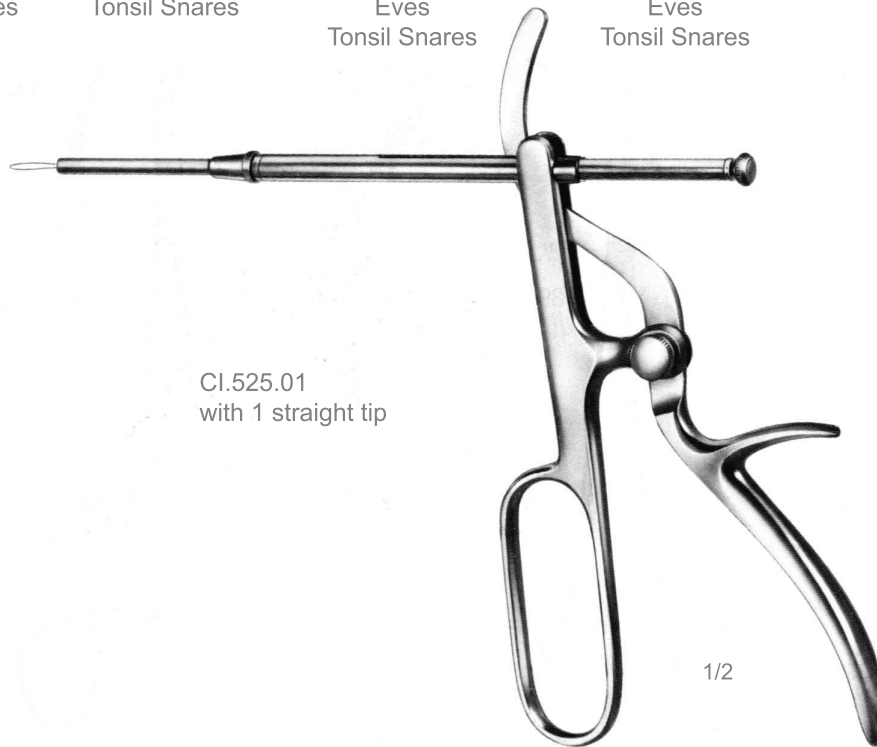

CI.525.01  
with 1 straight tip

1/2

**CI.525.01**  
Tyding  
Tonsil Snares

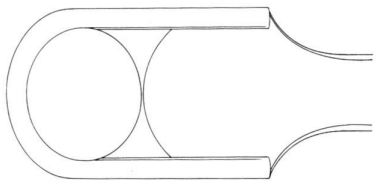

Fig. 1

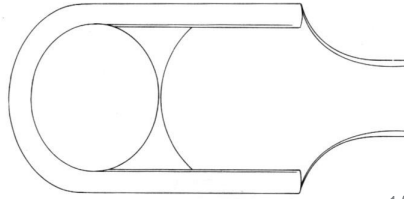

Fig. 2

1/1

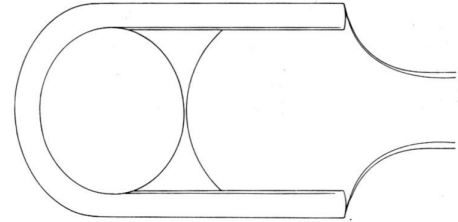
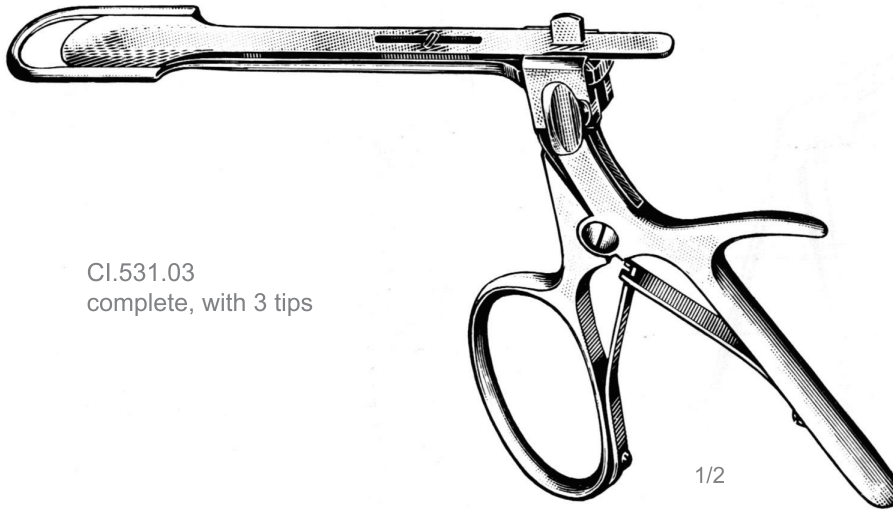

Fig. 3



CI.531.03  
complete, with 3 tips

1/2

**CI.531.03**  
Tonsillectomes

CI



**CI.541.13/17**  
Hartmann  
Tonsil Punch Forceps,  
Tonsil Haemostats

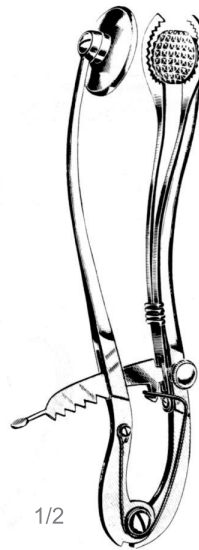
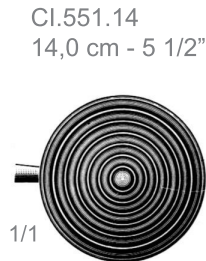

**CI.551.14**  
Corwin  
Tonsil Punch Forceps,  
Tonsil Haemostats

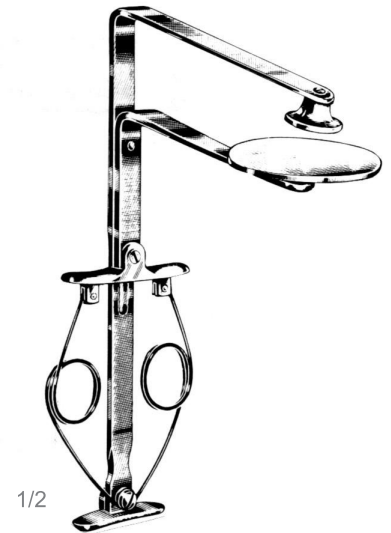
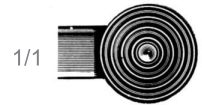

**CI.555.15**  
Vetter-Ulrich  
Tonsil Punch Forceps,  
Tonsil Haemostats

CI.541.13 - CI.541.17  
CI.541.14 - CI.555.15

- Tonsil Punch Forceps, through-cutting  
- Tonsil Haemostats

Universal Handles and Interchangeable Tubes, Broncho-Esophagoscope Forceps

# Kolpen

UNIVERSALGRIFFE UND VERLÄNGERUNGSROHRE,  
BRONCHO-DESOPHAGOSCOPIEZANGEN - MANGOS UNIVERSALES Y TUBOS DE  
EXTENSIÓN, PINZAS PARA BRONCO-ESOPHAGOSCOPIA

PALATE, TONSILS  
GAUMEN, TONSILLEN  
PALADAR, AMÍGDALAS

CI

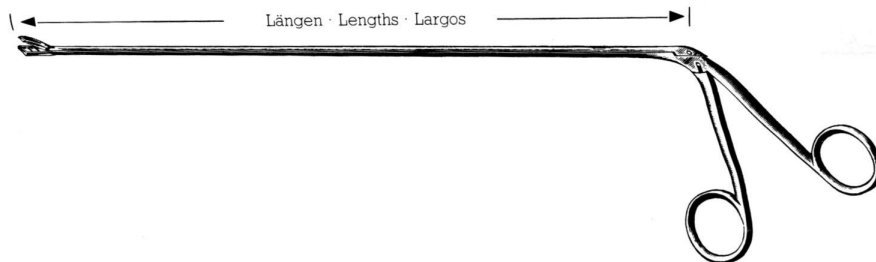

- CI.561.30/60
- CI.562.30/60
- CI.563.30/60
- CI.564.30/60
- CI.565.30/60
- CI.566.30/60
- CI.567.30/60

Chevalier-Jackson  
Universal Handle and  
Interchangeable Tubes,  
Broncho-Esophagoscope Forceps

lengths		1/1							
cm	in.								
30	12	CI.561.30	CI.562.30	CI.563.30	CI.564.30	CI.565.30	CI.566.30	CI.567.30	
40	16	CI.561.40	CI.562.40	CI.563.40	CI.564.40	CI.565.40	CI.566.40	CI.567.40	
50	20	CI.561.50	CI.562.50	CI.563.50	CI.564.50	CI.565.50	CI.566.50	CI.567.50	
60	24	CI.561.60	CI.562.60	CI.563.60	CI.564.60	CI.565.60	CI.566.60	CI.567.60	

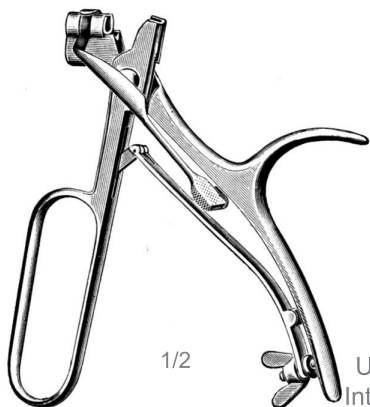

1/2

CI.581.01

Huber  
Universal Handle and  
Interchangeable Tubes,  
Broncho-Esophagoscope Forceps

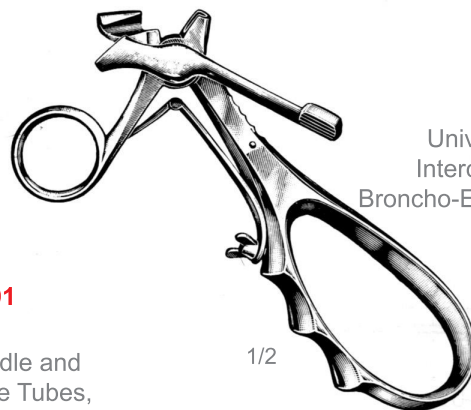

1/2

CI.583.01

Bruenings  
Universal Handle and  
Interchangeable Tubes,  
Broncho-Esophagoscope Forceps

1/2



CI.584.20/40

Universal Handle and  
Interchangeable Tubes,  
Broncho-Esophagoscope Forceps

lengths		straight
cm	in.	
20	8	CI.584.20
30	12	CI.584.30
40	16	CI.584.40

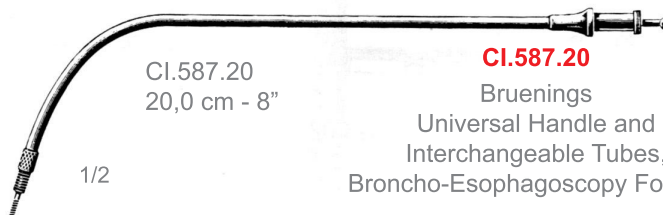

CI.587.20  
20,0 cm - 8"

1/2

CI.587.20

Bruenings  
Universal Handle and  
Interchangeable Tubes,  
Broncho-Esophagoscope Forceps

CI.561.30 - CI.567.60  
CI.581.01 - CI.583.01  
CI.587.20

- upper jaws movable  
- Universal Detachable Handles, for use with interchangeable tips and tubes  
- Laryngeal Tube for above mentioned handle

CI



**CI.600.01**  
Fraenkel

Cutting and Grasping Forceps Tips

1/1



**CI.604.01**  
Seiffert

Cutting and Grasping Forceps Tips

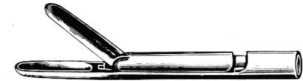

**CI.608.01**  
Fraenkel

Cutting and Grasping Forceps Tips



**CI.611.01**  
Scheimann

Cutting and Grasping Forceps Tips

1/1



**CI.613.01**  
Scheimann

Cutting and Grasping Forceps Tips

○ CI.616.02

○ CI.616.03



**CI.616.02/03**  
Bruenings

Cutting and Grasping Forceps Tips

○ CI.618.02

○ CI.618.03



**CI.618.02/03**  
Bruenings

Cutting and Grasping Forceps Tips

1/1



**CI.624.01**  
Lange

Cutting and Grasping Forceps Tips

⊕ CI.628.01

⊕ CI.628.02



**CI.628.01/02**  
Krause

Cutting and Grasping Forceps Tips

⊕ CI.637.01

⊕ CI.637.02

⊕ CI.637.03

⊕ CI.637.04



**CI.632.01**  
Krause

Cutting and Grasping Forceps Tips

1/1



**CI.637.01/04**  
Cordes

Cutting and Grasping Forceps Tips

△ with drawing cut



**CI.639.01**  
Schumacher

Cutting and Grasping Forceps Tips

⊕ CI.643.01

⊕ CI.643.02

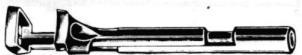

**CI.643.01/02**  
Cordes

Cutting and Grasping Forceps Tips

1/1



**CI.647.01**  
Cordes

Cutting and Grasping Forceps Tips



**CI.657.01**  
Rosenberg

Cutting and Grasping Forceps Tips

CI.600.01 - CI.657.01

- Cutting and Grasping Forceps Tips, for bronchial, laryngeal and esophageal work etc., to be screwed-on, only upper jaws movable, for use with tubes and stilettes CI.584.20 - CI.589.20 and universal handles CI.581.01 resp. CI.583.01

# Laryngeal Mirrors

KEHLKOPFSPIEGEL - ESPEJOS LARÍNGEOS

# Kolpen

PALATE, TONSILS  
GAUMEN, TONSILLEN  
PALADAR, AMÍGDALAS

CI

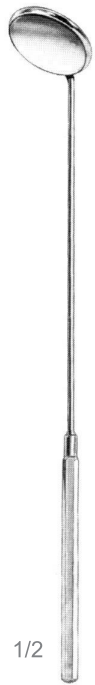

1/2

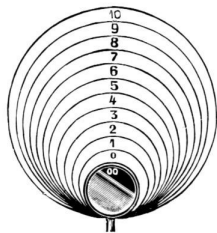

1/1



CI.789.12  
25,0 cm -  
10"



CI.789.14  
25,0 cm -  
10"

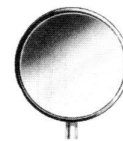

CI.789.16  
25,0 cm -  
10"

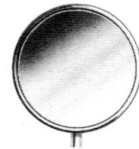

CI.789.18  
25,0 cm -  
10"

- |           |                  |           |
|-----------|------------------|-----------|
| CI.781.08 | Fig.00 - 8 mm Ø  | CI.785.08 |
| CI.781.10 | Fig. 0 - 10 mm Ø | CI.785.10 |
| CI.781.12 | Fig. 1 - 12 mm Ø | CI.785.12 |
| CI.781.14 | Fig. 2 - 14 mm Ø | CI.785.14 |
| CI.781.16 | Fig. 3 - 16 mm Ø | CI.785.16 |
| CI.781.18 | Fig. 4 - 18 mm Ø | CI.785.18 |
| CI.781.20 | Fig. 5 - 20 mm Ø | CI.785.20 |
| CI.781.22 | Fig. 6 - 22 mm Ø | CI.785.22 |
| CI.781.24 | Fig. 7 - 24 mm Ø | CI.785.24 |
| CI.781.26 | Fig. 8 - 26 mm Ø | CI.785.26 |
| CI.781.28 | Fig. 9 - 28 mm Ø | CI.785.28 |
| CI.781.30 | Fig.10 - 30 mm Ø | CI.785.30 |

**CI.789.12/18**  
Michel  
Laryngeal Mirrors

1/2

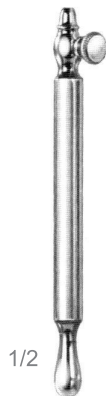

1/2

**CI.790.11**

Laryngeal Mirrors

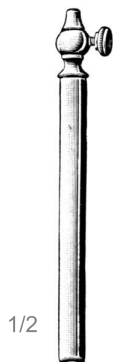

1/2

**CI.794.10**

Laryngeal Mirrors

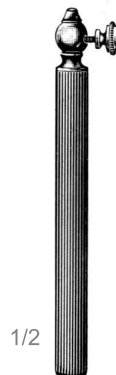

1/2

**CI.796.11**

Laryngeal Mirrors



1/2

**CI.798.12**

Laryngeal Mirrors

CI.781.08 - CI.781.30  
CI.785.08 - CI.785.30  
CI.790.11 - CI.798.12

- Laryngeal Mirrors with fixed handle  
- ditto, without handle  
- Metal Handles for laryngeal mirrors CI.785.08 - CI.785.30

# Kolpen

PALATE, TONSILS  
GAUMEN, TONSILLEN  
PALADAR, AMÍGDALAS

## Laryngeal Polypus Forceps, Epiglottis Retractor, Tampon Forceps

KEHLKOPFPOLYPENZANGEN, -DECKELHALTER, TAMPONPINZETTEN -  
PINZAS PARA PÓLIPOS LARÍNGEOS, DEPRESOR PARA EPIGLOTIS, PINZAS  
PARA TAPONAMIENTOS

CI

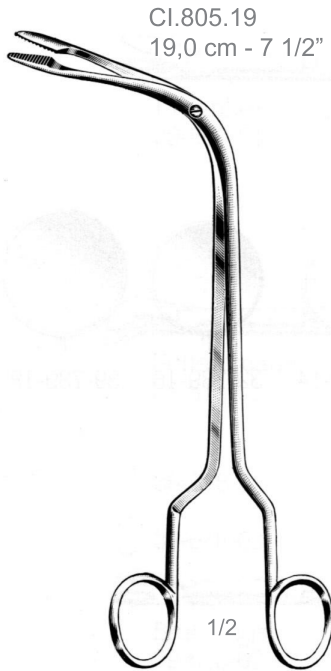

CI.805.19  
19,0 cm - 7 1/2"

**CI.805.19**  
Fraenkel

Laryngeal Polypus Forceps, Epiglottis  
Retractor, Tampon Forceps

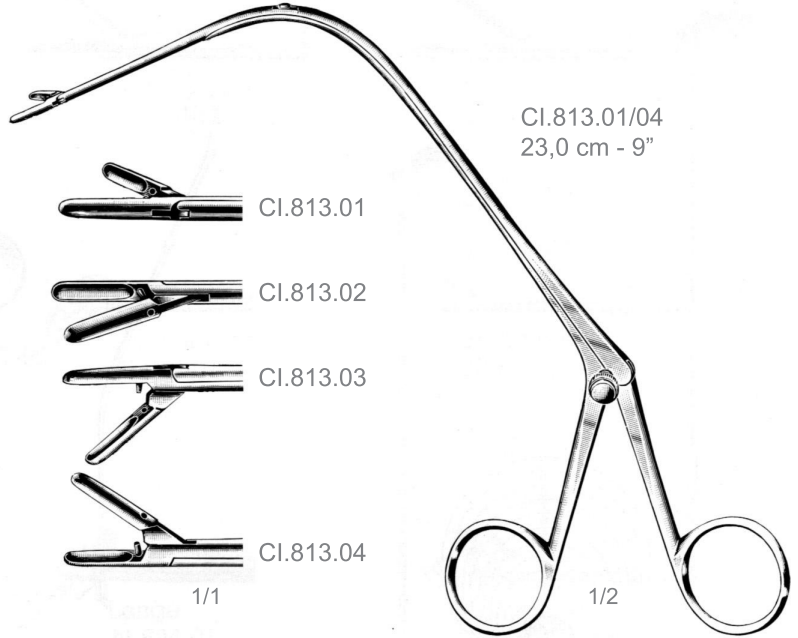

CI.813.01/04  
23,0 cm - 9"

**CI.813.01/04**  
Fraenkel

Laryngeal Polypus Forceps, Epiglottis  
Retractor, Tampon Forceps



1/1

CI.821.22  
22,0 cm -  
8 3/4"

CI.823.22  
22,0 cm -  
8 3/4"

**CI.821.22**  
**CI.823.22**  
Jackson

Laryngeal Polypus Forceps, Epiglottis  
Retractor, Tampon Forceps

1/2

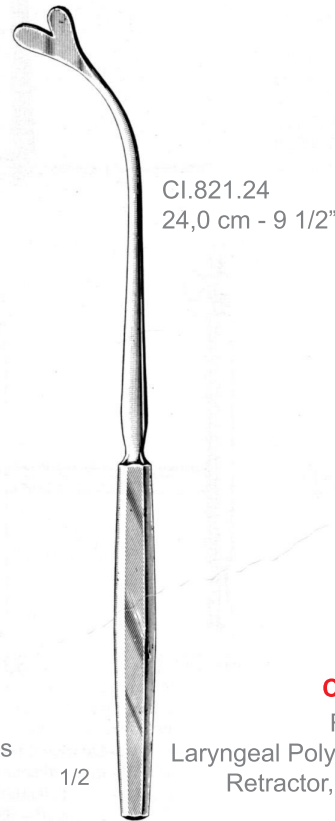

CI.821.24  
24,0 cm - 9 1/2"

**CI.821.24**  
Reichert

Laryngeal Polypus Forceps, Epiglottis  
Retractor, Tampon Forceps

1/2