

Kolpen

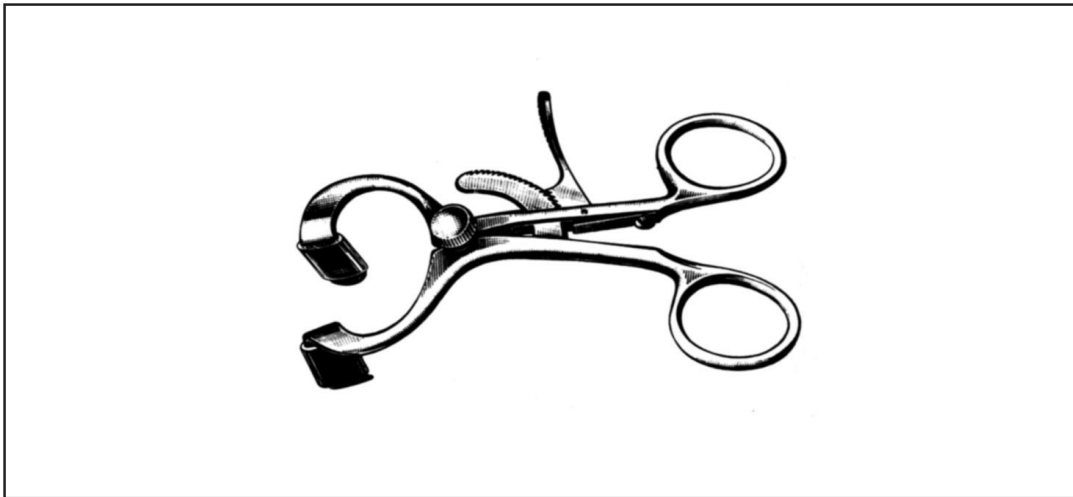

CH

Kolpen

ORAL, MAXILLLO-FACIAL SURGERY
MUND-, KIEFER- UND GESICHTSCHIRURGIE
CIRUGÍA ORAL Y MAXILLO-FACIAL

Napkin Holders, Finger Protectors, Oral Wedges

SERVIETTENHALTER, FINGERSCHÜTZER, MUNDKEILE
PORTA-SERVILLETAS, DEDALES, GARROTES

CH

CH.101.01
length adjustable



CH.101.01
Mod. Martin
Napkin Holders,
Finger Protectors,
Oral Wedges



CH.103.01
Adams
Napkin Holders,
Finger Protectors,
Oral Wedges



CH.111.01
CH.111.02
CH.111.03
CH.111.01/03
Langenbeck
Napkin Holders,
Finger Protectors,
Oral Wedges



CH.120.10
Maunder
Napkin Holders,
Finger Protectors,
Oral Wedges



CH.125.10
Pitha
Napkin Holders,
Finger Protectors,
Oral Wedges



CH.125.11
Napkin Holders,
Finger Protectors,
Oral Wedges



CH.127.02
28 x 30 x 30 mm
CH.127.02
Pitha
Napkin Holders,
Finger Protectors,
Oral Wedges

CH.101.01 - CH.103.01
CH.111.01 - CH.111.03
CH.120.10
CH.125.10
CH.125.11
CH.127.02

-Napkin Holders
-Finger Protectors
-Oral Screw, of wood
-Oral Wedge of silicone rubber with handle
-Spare Rubber Wedge
-Rubber Wedge, with chain

Plastic coated metal
frame without chain

1/2

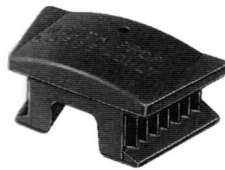

CH.130.50/58
McKesson
Mouth Gags

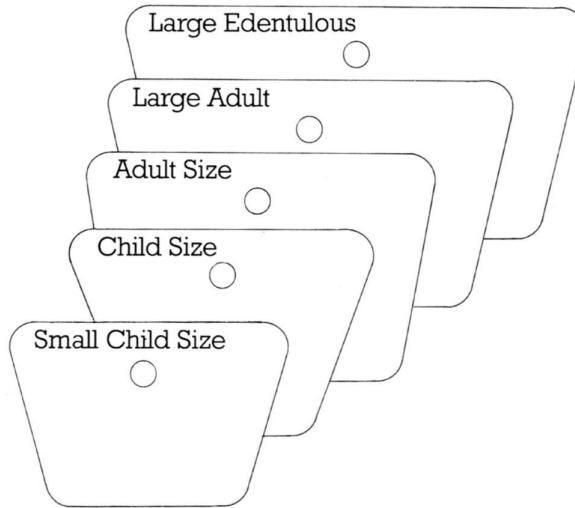

CH.130.50
Extra large, for edentulous

CH.130.52
Large, for adults

CH.130.54
Regular, for adults

CH.130.56
Small, for children

CH.130.58
Small, for babies

Plastic coated metal
frame with chain

1/2



CH.131.50/58
McKesson
Mouth Gags

CH.131.50
Large, for adults

CH.131.52
Regular, for adults

CH.131.56
Small, for children

CH.131.58
Small, for babies

Kolpen

ORAL, MAXILLO-FACIAL SURGERY
MUND-, KIEFER- UND GESICHTSCHIRURGIE
CIRUGÍA ORAL Y MAXILLO-FACIAL

Mouth Gags

MUNDSPERRER - ABRE-BOCAS

CH

CH.140.13
13,0 cm - 5"



CH.140.13
Heister
Mouth Gags

CH.161.13
11,0 cm - 4 1/2"



CH.161.13
Molt
Mouth Gags

CH.161.14
14,0 cm - 5 1/2"



CH.161.14
Molt
Mouth Gags

CH.171.12
12,0 cm - 4 3/4"



CH.179.16 16,0 cm - 6 1/4"
CH.179.19 19,0 cm - 7 1/2"

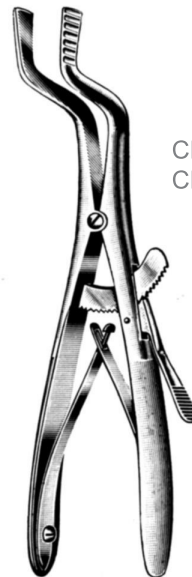

CH.179.16/19
Roser-König
Mouth Gags

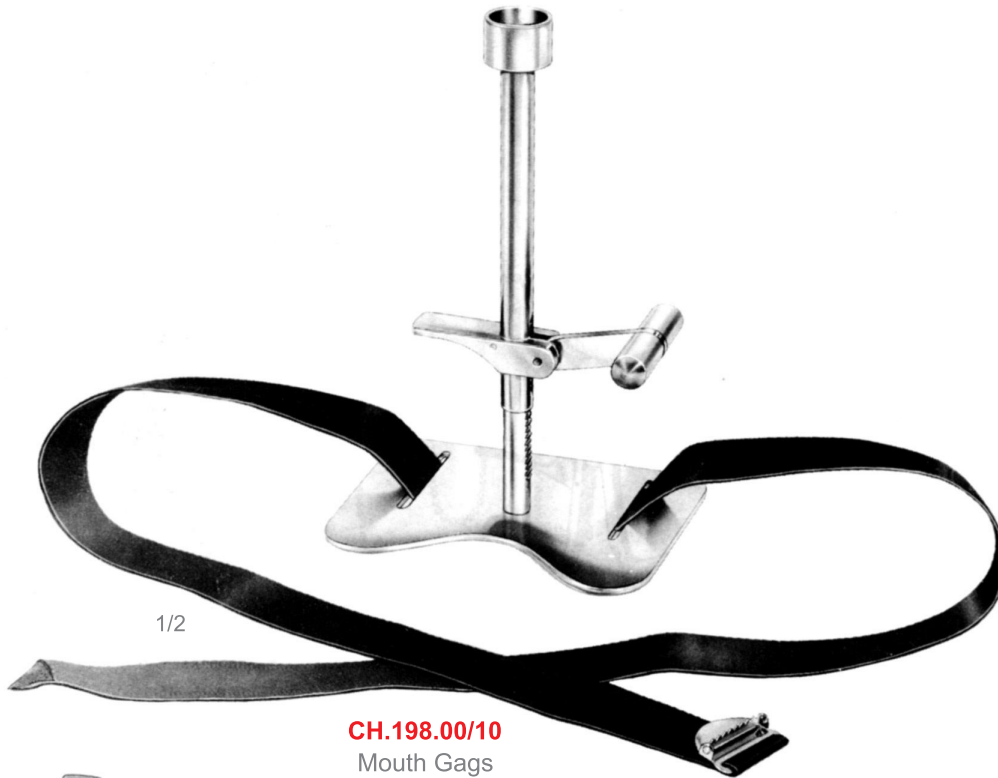

- CH.196.00 | -Chest Support for Mouth Gag
- CH.198.00 | -Complete with Frame, 3 Tongue Depressors and 2 Adjustable Tooth Plates, exchangeable, and 1 Palatal Support for toothless
- CH.198.01 | -Tongue Depressor
- CH.198.02 | -ditto
- CH.198.03 | -ditto
- CH.198.10 | -Gag only

CH



CH.212.00/10
Davis-Boyle
Mouth Gags

CH.212.10

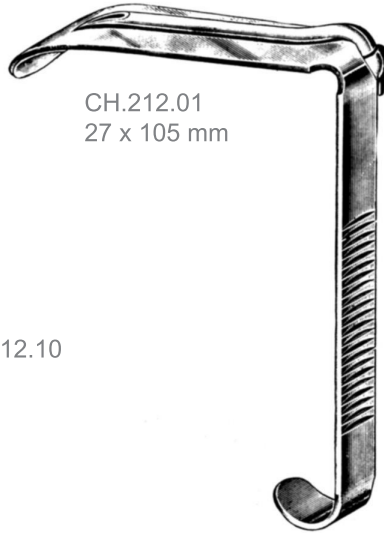

CH.212.01
27 x 105 mm



CH.212.02 25 x 90 mm
CH.212.03 25 x 75 mm
CH.212.04 22 x 60 mm
CH.212.05 20 x 25 mm

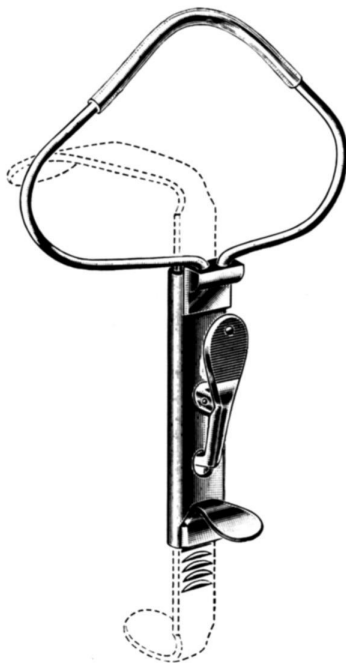

CH.222.00/10
McIvor
Mouth Gags

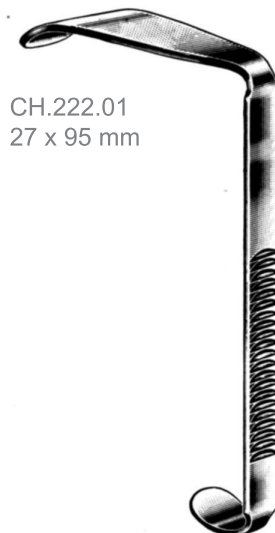

CH.222.01
27 x 95 mm



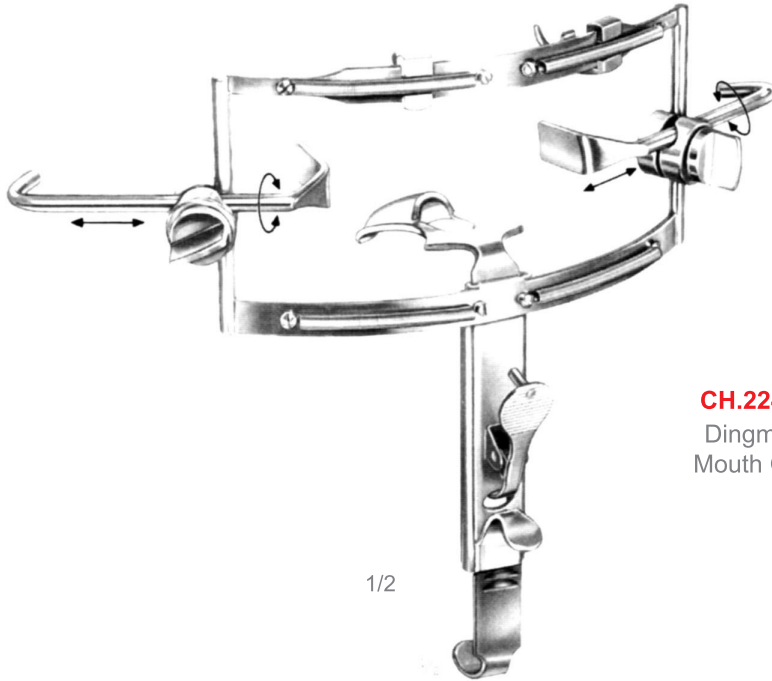

1/2

CH.224.00
Dingmann
Mouth Gags

CH.224.00
14,5 cm - 5 3/4"

Complete with frame, 3 tongue
depressors, and 2 adjustable
lateral blades

CH.224.01
13,5 cm - 5 1/4"
65 x 25 mm
Tongue Depressor

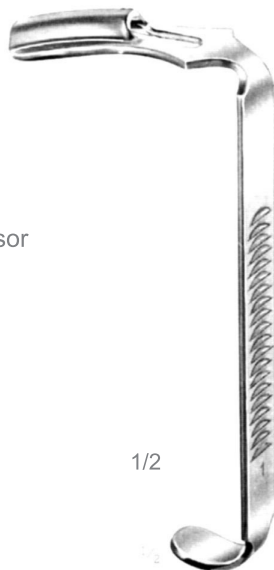

1/2

CH.224.01
Dingmann
Mouth Gags

CH.224.02
13,5 cm - 5 1/4"
70 x 29 mm
Tongue Depressor



1/2

CH.224.02
Dingmann
Mouth Gags

CH.224.03
13,5 cm - 5 1/4"
80 x 32 mm
Tongue Depressor



1/2

CH.224.03
Dingmann
Mouth Gags

CH

CH.231.11 11,0 cm - 4 1/4"
CH.231.13 13,0 cm - 5"
CH.231.15 15,0 cm - 6"

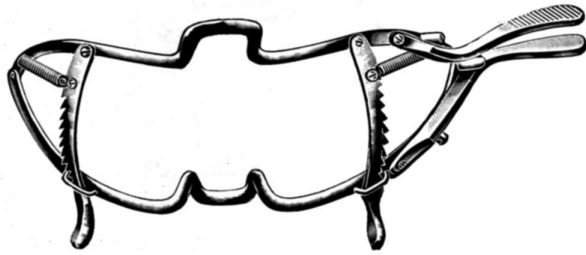

CH.231.11/15
Whitehead
Mouth Gags

CH.233.13 13,0 cm - 5"



CH.233.13
Whitehead
Mouth Gags

CH.237.09 9,0 cm - 3 1/2"
CH.237.11 11,0 cm - 4 1/2"
CH.237.13 13,0 cm - 5"
CH.237.15 15,0 cm - 6"

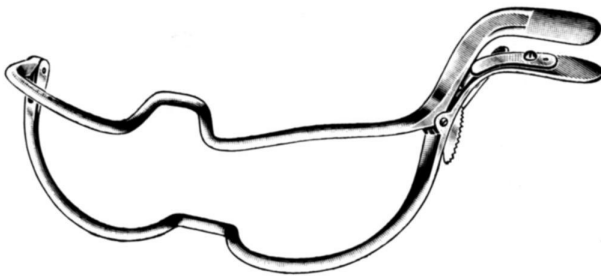

CH.237.09/15
Jennings
Mouth Gags

CH.239.09 9,0 cm - 3 1/2"
CH.239.11 11,0 cm - 4 1/2"
CH.239.13 13,0 cm - 5"
CH.239.15 15,0 cm - 6"



CH.239.09/15
Seemann-Seiffert
Mouth Gags

Cheek Retractors

WANGENHALTER - SEPARADORES PARA MEJILLA

Kolpen

ORAL, MAXILLO-FACIAL SURGERY
MUND-, KIEFER- UND GESICHTSCHIRURGIE
CIRUGÍA ORAL Y MAXILLO-FACIAL

CH

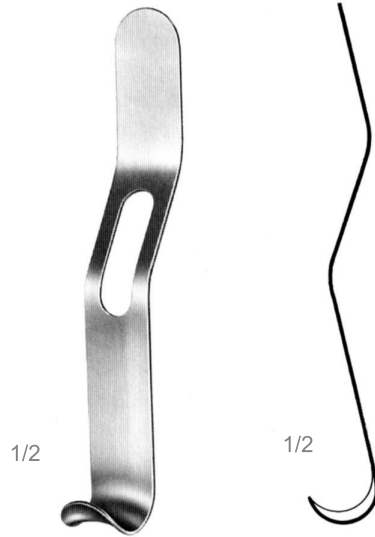

CH.265.00 14,5 cm - 5 3/4"
Fenestrated

CH.265.00
Cheek Retractors

CH



CH.240.00/13

Oringer
Cheek-lip retractor

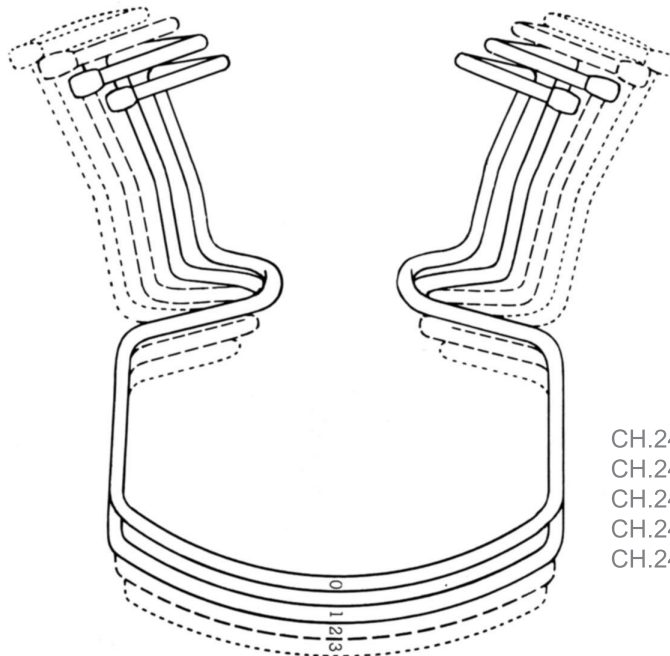

- CH.240.01 = Fig. 0 for children
- CH.240.00 = Fig. 1
- CH.240.02 = Fig. 2
- CH.240.03 = Fig. 3
- CH.240.13 = Set - Fig. 1-3

Cheek and Lip Retractors, Tongue Depressors

WANGEN- UND LIPPENHALTER, ZUNGENDRÜCKER -
SEPARADORES PARA LABIOS Y MEJILLAS, ABAJA-LINGUAS

Kolpen

ORAL, MAXILLO-FACIAL SURGERY
MUND-, KIEFER- UND GESICHTSCHIRURGIE
CIRUGÍA ORAL Y MAXILLO-FACIAL

CH

CH.243.11 11,0 cm - 4 1/2"



CH.243.11

Martin-Simplex
Cheek and Lip Retractors
Tongue Depressors



CH.247.14
14,0 cm - 5 1/2"

CH.247.16
16,0 cm - 6 1/4"

CH.247.18
18,0 cm - 7"

CH.247.14/18

Stemberg
Cheek and Lip Retractors
Tongue Depressors



CH.249.12
12,0 cm - 4 3/4"

CH.249.14
14,0 cm - 5 1/2"

CH.249.16
16,0 cm - 6 1/4"

CH.249.12/16

Stemberg
Cheek and Lip Retractors
Tongue Depressors

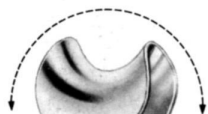

CH.255.19
19,0 cm - 7 1/2"

1/2

CH.255.19

Mod. Martin
Cheek and Lip Retractors
Tongue Depressors



CH.257.21
21,0 cm - 8 1/4"

CH.257.21

Mod. Martin
Cheek and Lip Retractors
Tongue Depressors



CH.261.13
13,0 cm - 5"

1/2

CH.261.13

Bishop
Cheek and Lip Retractors
Tongue Depressors

Kolpen

ORAL, MAXILLO-FACIAL SURGERY
MUND-, KIEFER- UND GESICHTSCHIRURGIE
CIRUGÍA ORAL Y MAXILLO-FACIAL

Cawood-Minnesota Retractor

CAWOOD-MINNESOTA WANGENHALTER
SEPARADOR CAWOOD-MINNESOTA

CH

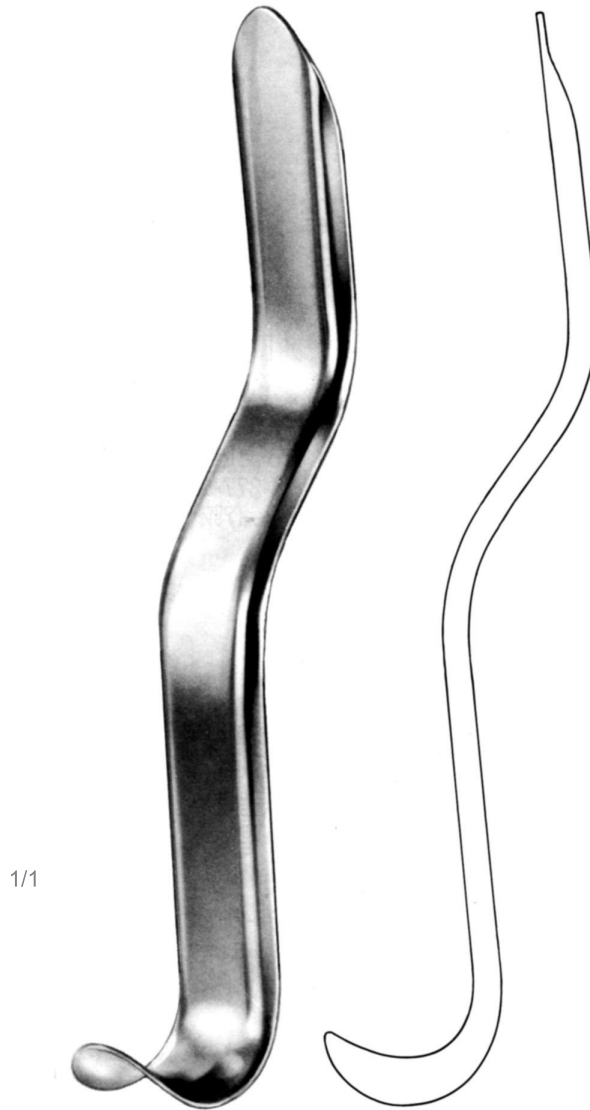

CH.263.15

Cawood
Cawood-Minnesota
Retractor

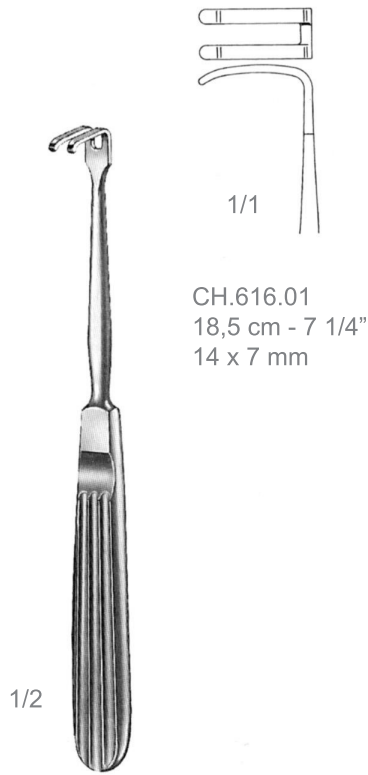

CH.616.01
18,5 cm - 7 1/4"
14 x 7 mm

CH.616.01/02
Retractors, periosteal
elevators

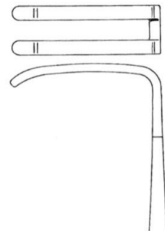
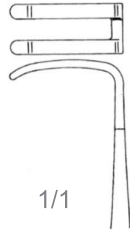

Koberg, Mod.
CH.616.02
18,5 cm - 7 1/4"
20 x 7 mm



CH.618.01
18,0 cm - 7"
3 x 18 mm

CH.618.01
Retractors, periosteal
elevators



CH.618.02
18,0 cm - 7"
3,5 x 23 mm

CH.618.02
Retractors, periosteal
elevators

1/1



Kolpen

ORAL, MAXILLO-FACIAL SURGERY
MUND-, KIEFER- UND GESICHTSCHIRURGIE
CIRUGÍA ORAL Y MAXILLO-FACIAL

Cheek and Lip Retractors, Tongue Depressors

WANGEN- UND LIPPENHALTER, ZUNGENDRÜCKER
SEPARADORES PARA LABIOS Y MEJILLAS, ABAJA-LENGUAS

CH

CH.265.19
19,0 cm - 7 1/2"



CH.265.19

Moritz-Schmidt
Cheek and Lip Retractors,
Tongue Depressors

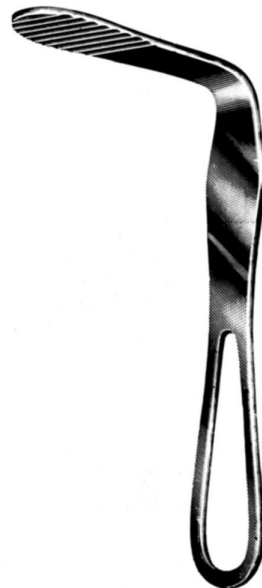

CH.271.15
15,0 cm - 6"

CH.271.15

Hartmann
Cheek and Lip Retractors,
Tongue Depressors



CH.271.15
15,0 cm - 6"

CH.277.14

Tobold
Cheek and Lip Retractors,
Tongue Depressors

Cheek and Lip Retractors, Tongue Depressors

WANGEN- UND LIPPENHALTER, ZUNGENDRÜCKER
SEPARADORES PARA LABIOS Y MEJILLAS, ABAJA-LENGUAS

Kolpen

ORAL, MAXILLO-FACIAL SURGERY
MUND-, KIEFER- UND GESICHTSCHIRURGIE
CIRUGÍA ORAL Y MAXILLO-FACIAL

CH

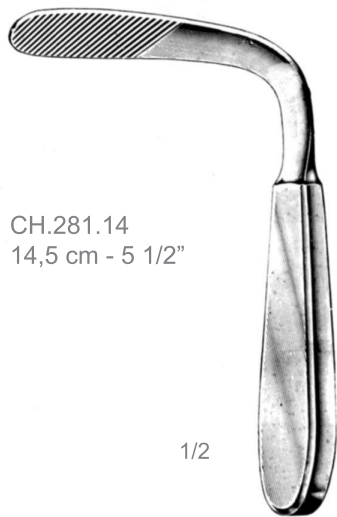

CH.281.14
14,5 cm - 5 1/2"

1/2

CH.281.14
Tobold
Cheek and Lip Retractors,
Tongue Depressors



CH.293.11
11,0 cm - 4 1/2"

1/2

CH.293.11
Andrew
Cheek and Lip Retractors,
Tongue Depressors

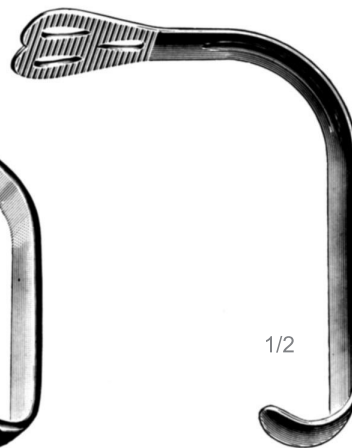

1/2

CH.297.01/02
Wieder
Cheek and Lip Retractors,
Tongue Depressors



1/2

CH.297.01
14,0 cm - 5 1/2"

CH.297.02
15,0 cm - 6"

Kolpen

Tongue Depressors

ORAL, MAXILLO-FACIAL SURGERY
MUND-, KIEFER- UND GESICHTSCHIRURGIE
CIRUGÍA ORAL Y MAXILLO-FACIAL

ZUNGENSPEL - ABAJA-LENGUA

CH

CH.350.16
16,0 cm - 6 1/4"
of wood



1/2

CH.350.16
Tongue
Depressors

CH.352.15
15,0 cm - 6"
of plastic



1/2

CH.352.15
Tongue
Depressors

CH.356.16
16,0 cm - 6 1/4"
of acrylic glass



1/2

CH.356.16
Haas
Tongue
Depressors

CH.361.17
17,0 cm - 6 3/4"
of acrylic glass

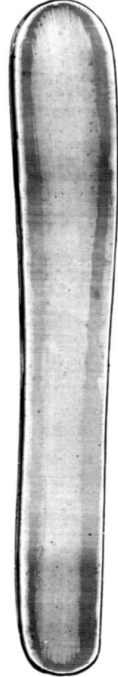

1/2

CH.361.17
Buchwald
Tongue
Depressors

CH.363.18
18,5 cm - 7 1/4"
can be autoclave
of blue nylon



1/2

CH.363.18
Martin-Boilable
Tongue
Depressors

CH.371.14
14,5 cm - 5 3/4"



1/2

CH.371.14
Tongue
Depressors

CH.373.14
14,5 cm - 5 3/4"

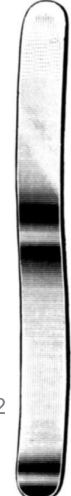

1/2

CH.373.14
Tongue
Depressors

CH.375.13
13,0 cm - 5"

CH.375.16
16,0 cm - 6 1/4"



1/2

CH.375.13/16
Doyen
Tongue
Depressors

CH.379.15
15,0 cm - 6"



1/2

CH.379.15
Kroenig
Tongue
Depressors

CH.382.17
17,0 cm - 6 3/4"



1/2

CH.382.17
Mayo
Tongue
Depressors



1/2

CH.385.19
Bruenings
Tongue
Depressors

CH.385.19
19,0 cm -
7 1/2"



1/2

CH.393.16
Collin
Tongue
Depressors

CH.393.16
16,5 cm -
6 1/2"



1/2

CH.395.16
Mod. Martin
Tongue
Depressors

CH.395.16
16,5 cm -
6 1/2"

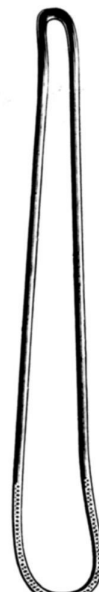

1/2

CH.397.16
Frenzel
Tongue
Depressors

CH.397.16
16,5 cm -
6 1/2"

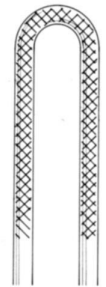

Tongue Holding Forceps

ZUNGENZANGEN - PINZAS PARA TIRA-LENGUA

Kolpen

ORAL, MAXILLO-FACIAL SURGERY
MUND-, KIEFER- UND GESICHTSCHIRURGIE
CIRUGÍA ORAL Y MAXILLO-FACIAL

CH

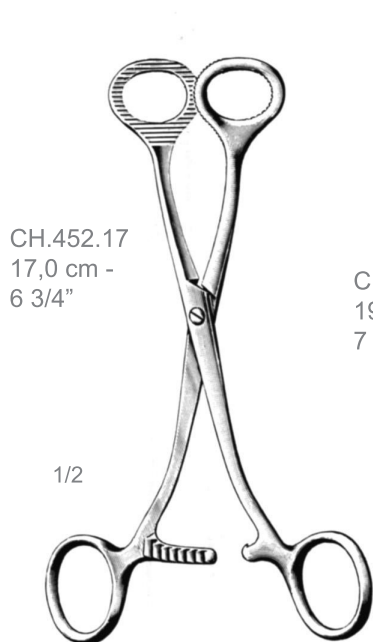

CH.452.17
Collin
Tongue
Holding Forceps

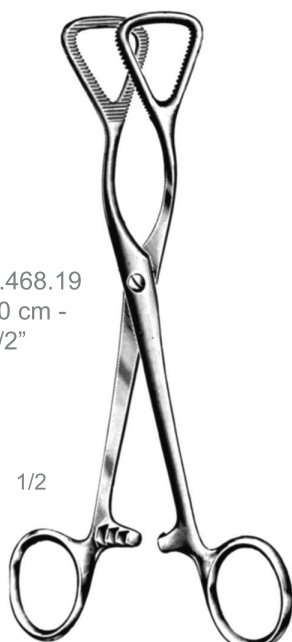

CH.458.19
Guy
Tongue
Holding Forceps

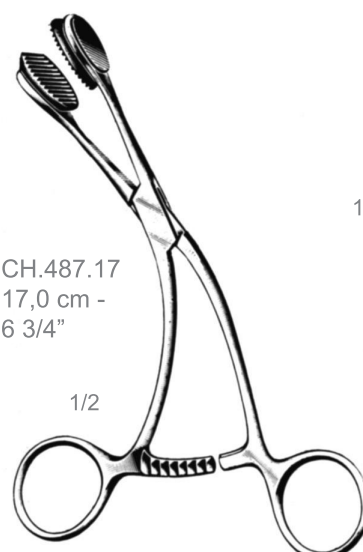

CH.467.17
Young
Tongue
Holding Forceps



CH.468.02
Tongue
Holding Forceps

CH.468.02
Pair

Kolpen

ORAL, MAXILLO-FACIAL SURGERY
MUND-, KIEFER- UND GESICHTSCHIRURGIE
CIRUGÍA ORAL Y MAXILLO-FACIAL

Extra Oral Retractors

EXTRA ORALE RETRAKTOREN - RETRACTORES EXTRA ORALES

CH

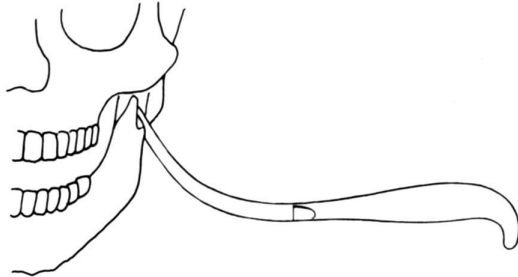

CH.501.24
24,0 cm - 9 1/2"



1/2

CH.501.24
Extra Oral
Retractors

CH.503.27
27,0 cm - 10 1/2"

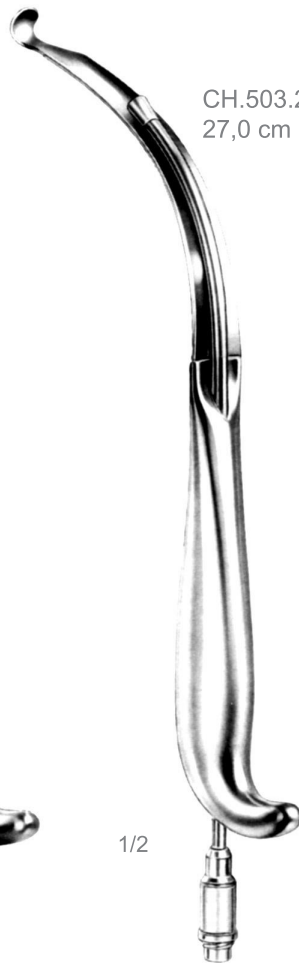

1/2

CH.503.27
Extra Oral
Retractors

1/1

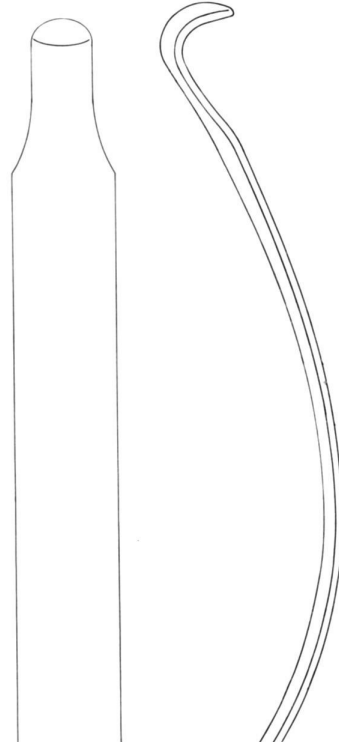

CH.501.24 - without fiber optics
CH.503.27 - with fiber optics

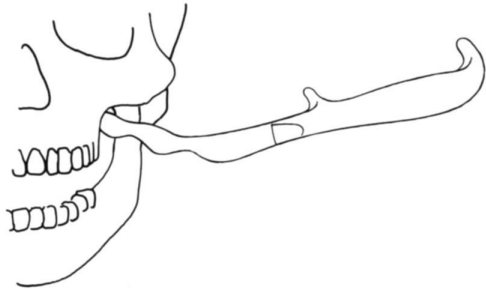

1/2

CH.505.24
Intra Oral
Retractors



1/2

CH.507.27
Intra Oral
Retractors

1/1

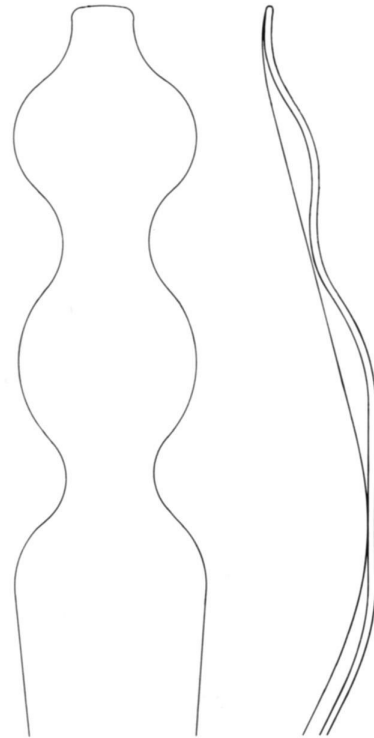

CH.505.24 - without fiber optics for LeFort Osteotomy
CH.507.27 - with fiber optics for LeFort Osteotomy

Kolpen

Intra Oral Retractors

ORAL, MAXILLO-FACIAL SURGERY
MUND-, KIEFER- UND GESICHTSCHIRURGIE
CIRUGÍA ORAL Y MAXILLO-FACIAL

INTRA ORALE RETRAKTOREN - RETRACTORES INTRA ORALES

CH

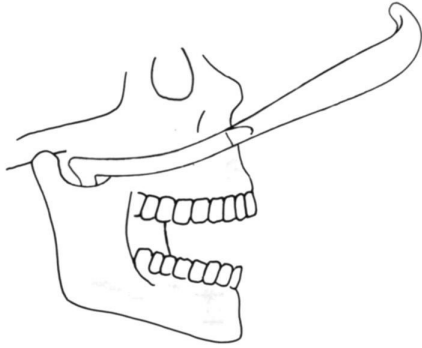

CH.509.21 21,0 cm - 8 1/2" CH.511.21 21,0 cm - 8 1/2"
CH.513.24 24,0 cm - 9 1/2" CH.515.24 24,0 cm - 9 1/2"



1/2

CH.509.21
Intra Oral
Retractors



CH.511.21
Intra Oral
Retractors



CH.513.24
Intra Oral
Retractors



CH.515.24
Intra Oral
Retractors

1/1

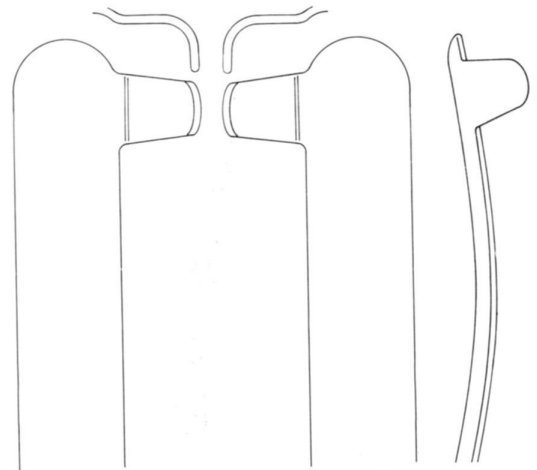

CH.509.21 - without fiber optics, right
CH.511.21 - without fiber optics, left
CH.513.24 - with fiber optics, right
CH.515.24 - with fiber optics, left

Intra Oral Retractors

INTRA ORALE RETRAKTOREN - RETRACTORES INTRA ORALES

Kolpen

ORAL, MAXILLO-FACIAL SURGERY
MUND-, KIEFER- UND GESICHTSCHIRURGIE
CIRUGÍA ORAL Y MAXILLO-FACIAL

CH

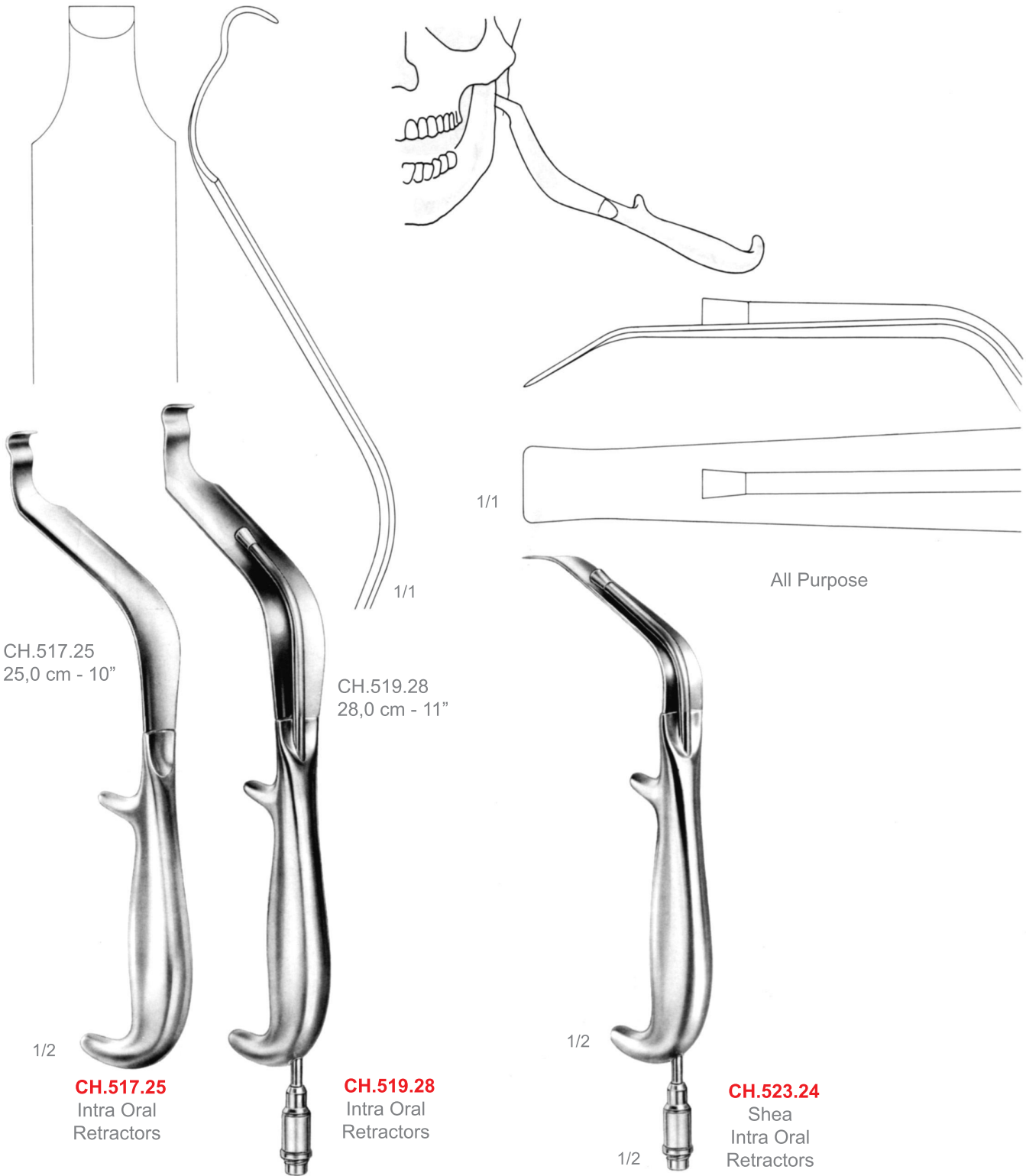

CH.517.25
25,0 cm - 10"

CH.519.28
28,0 cm - 11"

All Purpose

CH.517.25
Intra Oral
Retractors

CH.519.28
Intra Oral
Retractors

CH.523.24
Shea
Intra Oral
Retractors

- CH.517.25 - without fiber optics, L & M for Vertical Osteotomy
- CH.519.25 - with fiber optics, L & M for Vertical Osteotomy
- CH.523.24 - with fiber optic

Kolpen

ORAL, MAXILLO-FACIAL SURGERY
MUND-, KIEFER- UND GESICHTSCHIRURGIE
CIRUGÍA ORAL Y MAXILLO-FACIAL

Ramus retractors

RAMUSHAKEN - SEPARADORES DE RAMA

CH

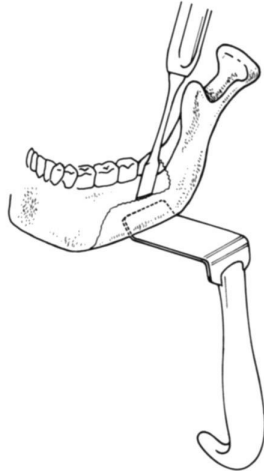

1/2

CH.591.20/35
Ramus
retractors

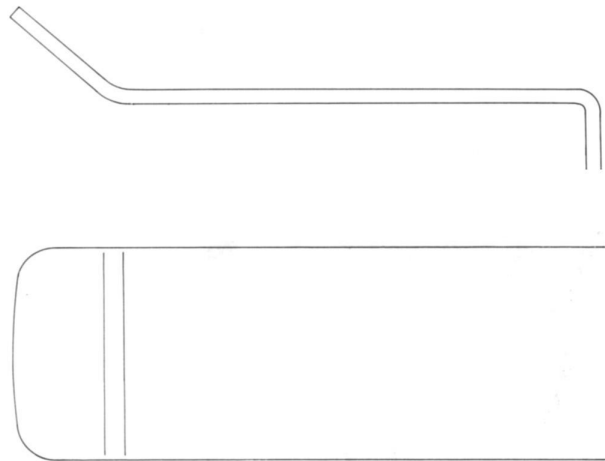

CH.591.20	16,0 cm - 6 1/4"	20 mm
CH.591.25	16,0 cm - 6 1/4"	25 mm
CH.591.30	16,0 cm - 6 1/4"	30 mm
CH.591.35	16,0 cm - 6 1/4"	35 mm

Soft Tissue Retractors

WEICHTEILHAKEN - SEPARADORES

Kolpen

ORAL, MAXILLO-FACIAL SURGERY
MUND-, KIEFER- UND GESICHTSCHIRURGIE
CIRUGÍA ORAL Y MAXILLO-FACIAL

CH

AE.317.01	21,5 cm - 8 1/2"	6 x 25 mm
AE.317.02	21,5 cm - 8 1/2"	8 x 35 mm
AE.317.05	21,5 cm - 8 1/2"	11 x 40 mm
AE.317.06	21,5 cm - 8 1/2"	11 x 55 mm
AE.317.07	21,5 cm - 8 1/2"	14 x 70 mm
AE.317.09	21,5 cm - 8 1/2"	16 x 80 mm

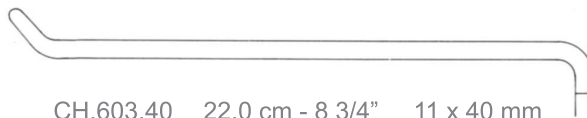
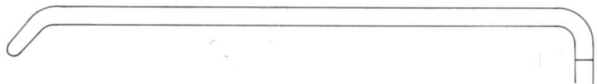

CH.603.40	22,0 cm - 8 3/4"	11 x 40 mm
CH.603.55	22,0 cm - 8 3/4"	11 x 55 mm
CH.603.80	22,0 cm - 8 3/4"	16 x 80 mm



Obwegeser
(Kocher-Langenbeck)
Soft Tissue
Retractors



CH.603.40/80
Obwegeser
Soft Tissue
Retractors

Kolpen

ORAL, MAXILLO-FACIAL SURGERY
MUND-, KIEFER- UND GESICHTSCHIRURGIE
CIRUGÍA ORAL Y MAXILLO-FACIAL

Ramus retractors

RAMUSHAKEN - SEPARADORES DE RAMA

CH

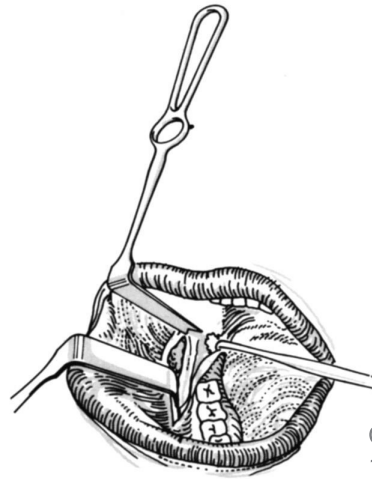

CH.605.22 22,0 cm - 8 3/4"
10 x 42 mm

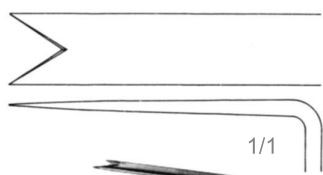

CH.605.22
Obwegeser
Ramus
retractors

CH.607.22 22,0 cm - 8 3/4"
11 x 70 mm

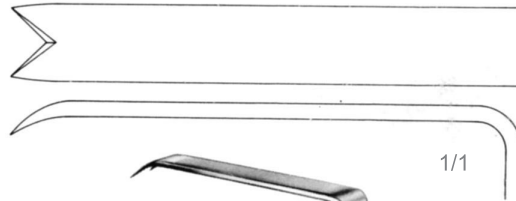

CH.607.22
Obwegeser
Ramus
retractors

Chin retractor and Channelled Retractors

KINNHALTER UND PROGENIEHAKEN -

GANCHO PARA EL MENTON Y SEPARADORES PARA PROGENISMO

Kolpen

ORAL, MAXILLO-FACIAL SURGERY

MUND-, KIEFER- UND GESICHTSCHIRURGIE

CIRUGÍA ORAL Y MAXILLO-FACIAL

CH

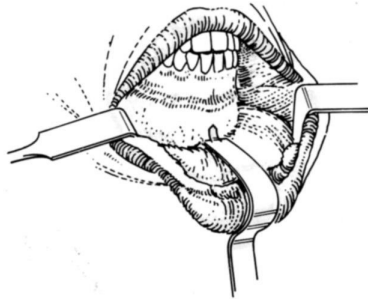

CH.611.16
16,0 cm - 6 1/2"

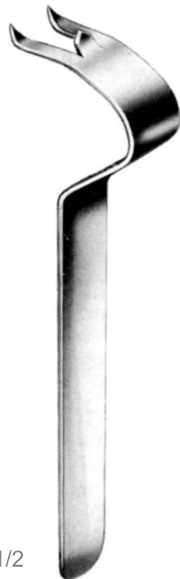

1/2

CH.611.16
Obwegeser
Chin retractor and
Channelled Retractors

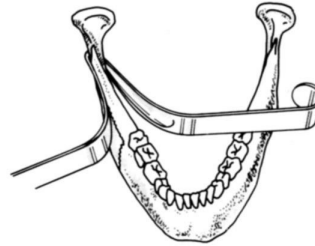

CH.613.08 8 mm
CH.613.10 10 mm
16,0 cm - 6 1/2"



1/2

CH.613.08/10
Obwegeser
Chin retractor and
Channelled Retractors

CH



1/2

CH.630.06/11
Obwegeser
Periosteal
Elevators



CH.630.06 6 mm
CH.630.07 7 mm
CH.630.09 9 mm
CH.630.11 11 mm
17,5 cm - 7 1/4"



1/2

CH.631.05/09
Obwegeser
Periosteal
Elevators

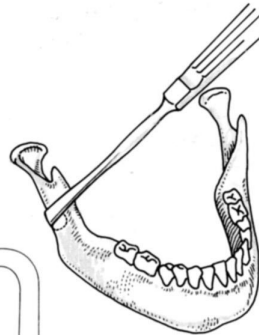

CH.631.05 5 mm
CH.631.07 7 mm
CH.631.09 9 mm
20 cm - 8"

Periosteal Elevators, Osteotomes

RASPATORIEN, OSTEOTOME - PERIOSTÓTOMOS, OSTEÓTOMOS

Kolpen

ORAL, MAXILLLO-FACIAL SURGERY
MUND-, KIEFER- UND GESICHTSCHIRURGIE
CIRUGÍA ORAL Y MAXILLO-FACIAL

CH

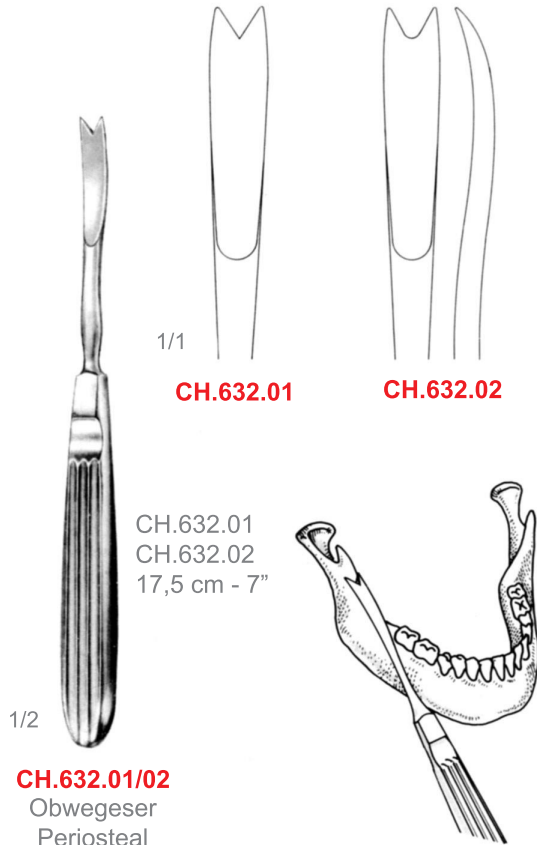

1/1

CH.632.01

CH.632.02

CH.632.01
CH.632.02
17,5 cm - 7"

1/2

CH.632.01/02

Obwegeser
Periosteal
Elevators,
Osteotome



1/1

CH.640.21
21,0 cm - 8 1/2"

1/1

CH.642.21
21,0 cm - 8 1/2"

1/2

CH.640.21

Obwegeser
Periosteal
Elevators,
Osteotome

1/2

CH.642.21

Obwegeser
Periosteal
Elevators,
Osteotome

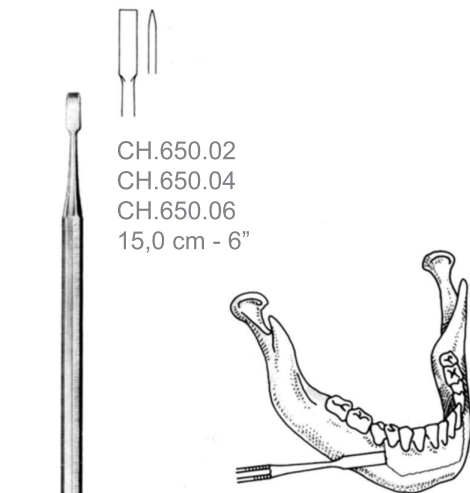

CH.650.02
CH.650.04
CH.650.06
15,0 cm - 6"

1/2

CH.650.02/06

Obwegeser
Periosteal
Elevators,
Osteotome

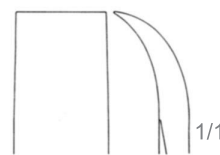

CH.656.24
23,5 cm - 9 1/4"

1/2

CH.656.24

Obwegeser
Periosteal
Elevators,
Osteotome



1/1

CH.660.19 **CH.662.19**

CH.660.19
CH.662.19
18,5 cm - 7 1/4"

1/2

CH.660.19

CH.662.19
Obwegeser
Periosteal
Elevators,
Osteotome

Kolpen

Awls

ORAL, MAXILLO-FACIAL SURGERY
MUND-, KIEFER- UND GESICHTSCHIRURGIE
CIRUGÍA ORAL Y MAXILLO-FACIAL

AHLEN - LEZNAS

CH

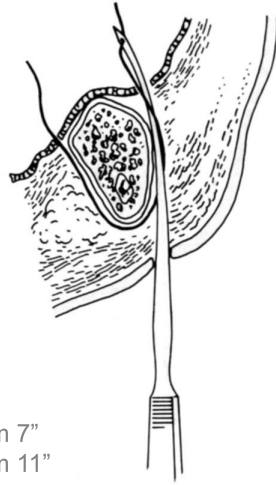

CH.675.18 - 18,0 cm 7"
CH.675.28 - 28,0 cm 11"



CH.675.18/28
Obwegeser
Awls



1/2

CH.677.13
Obwegeser
Awls



1/2

CH.679.23
Obwegeser
Awls



1/1

CH.679.23
23,0 cm 9"



1/2

CH.681.15
Kelsey-Fry
Awls

Awl for the
lower jaw



1/2

CH.681.18
Kelsey-Fry
Awls

Awl for the
upper jaw

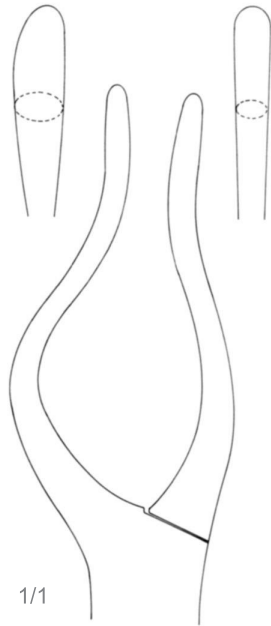

CH.700.01
CH.701.01
Disimpaction
Forceps

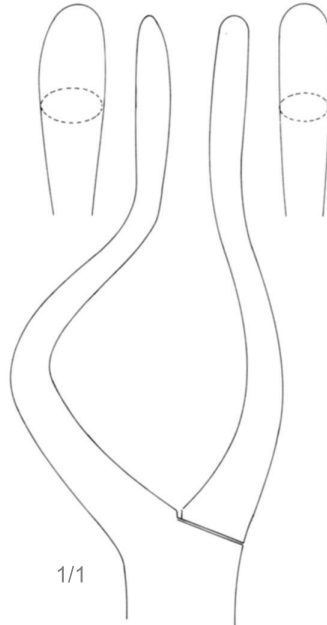

CH.700.02
CH.701.02
Disimpaction
Forceps

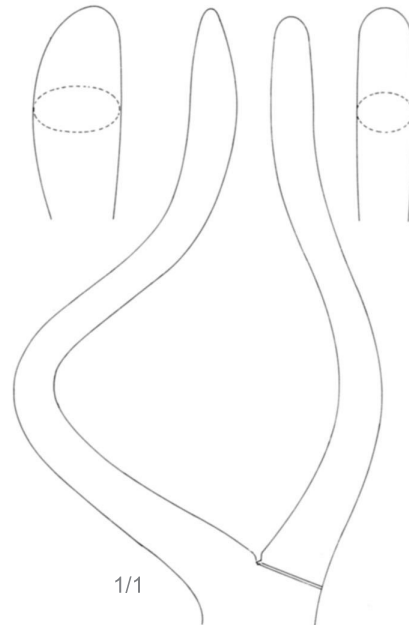

CH.700.03
CH.701.03
Disimpaction
Forceps



left

CH.700.01/03
Rowe
Disimpaction
Forceps



right

CH.701.01/03
Rowe
Disimpaction
Forceps

CH

(L)

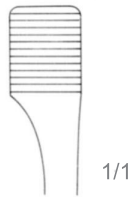

(R)



1/2

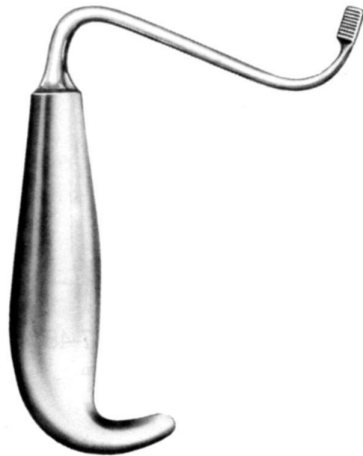

CH.711.01
Tessier
Maxillary
Mobilizers

1/2

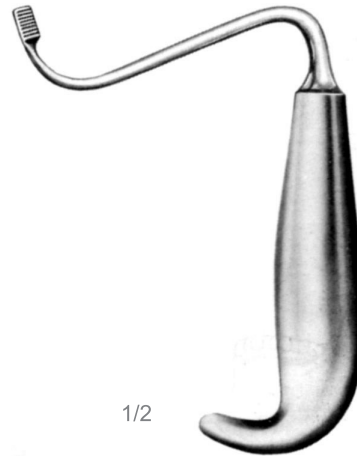

CH.711.02
Tessier
Maxillary
Mobilizers

Temporo-Mandibular Joint Instruments (TJM)

KIEFERGELENK-INSTRUMENTE -
 INSTRUMENTAL PARA LA ARTICULACIÓN MANDIBULAR

Kolpen

ORAL, MAXILLO-FACIAL SURGERY
 MUND-, KIEFER- UND GESICHTSCHIRURGIE
 CIRUGÍA ORAL Y MAXILLO-FACIAL

CH

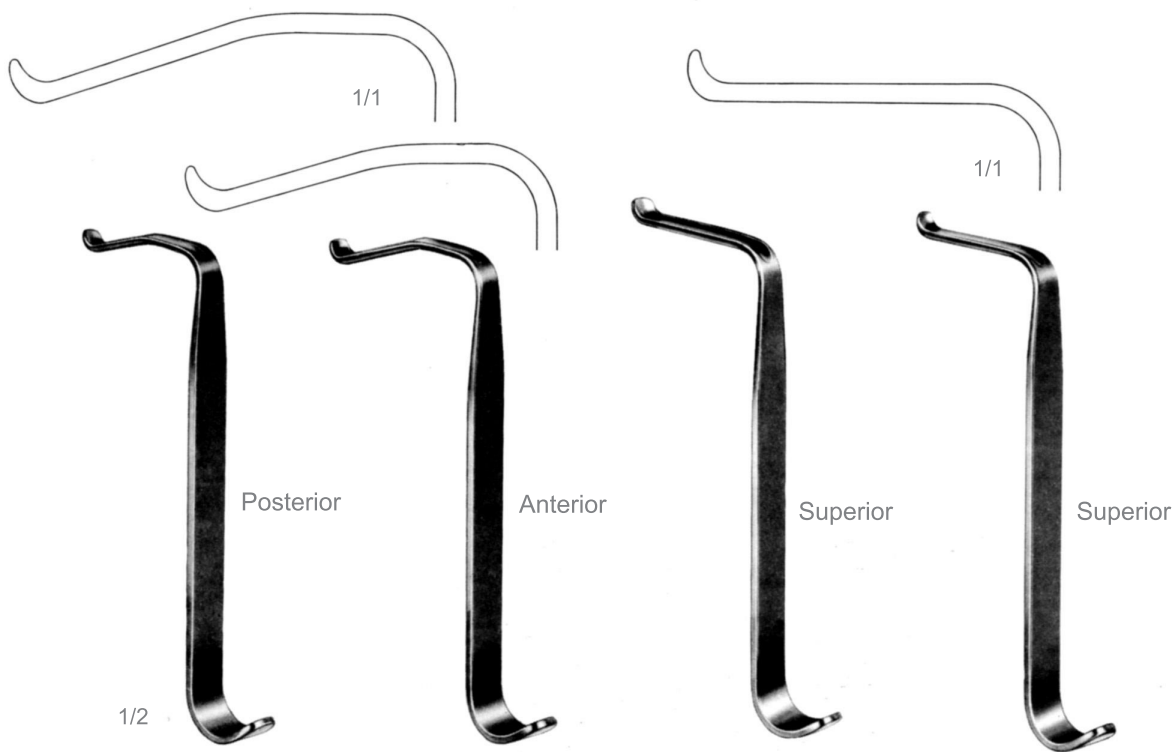

- CH.725.01 6,5 x 50 mm
- CH.725.02 6,5 x 60 mm
- CH.725.03 8,0 x 50 mm
- CH.725.04 6,5 x 50 mm

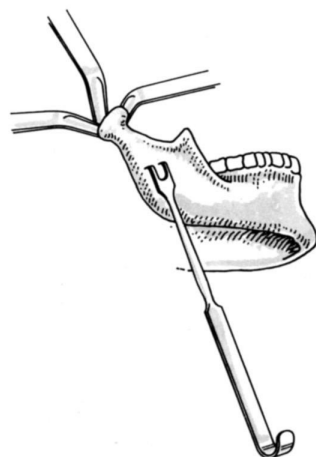

Lateral



CH.726.01
 13,5 cm - 5 1/2"

CH.726.01
 Dunn-Dautrey
 Temporo-Mandibular
 Joint Instruments

1/2



1/1

- CH.727.48 6,0 x 48 mm
- CH.727.56 6,0 x 56 mm
- 15,5 cm - 6"

CH.727.48/56
 Dunn-Dautrey
 Temporo-Mandibular
 Joint Instruments