

Kolpen

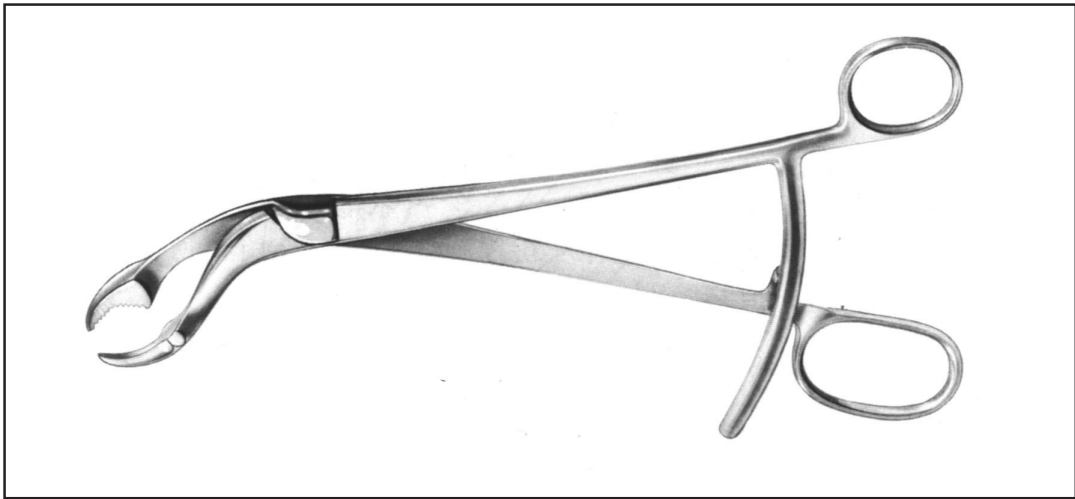

BC

BC

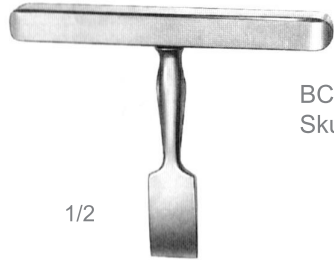

BC.036.00
Skull Braker

BC.036.00
Virchow
Bone Chisels
and Gouges

1/2



1/1

BC.060.02 16,0 cm - 6 1/4" 2 mm
BC.060.03 16,0 cm - 6 1/4" 3 mm
BC.060.04 16,0 cm - 6 1/4" 4 mm

BC.060.02/04
BC.061.02/04
Buckley
Bone Chisels
and Gouges



1/1

BC.061.02 16,0 cm - 6 1/4" 2 mm
BC.061.03 16,0 cm - 6 1/4" 3 mm
BC.061.04 16,0 cm - 6 1/4" 4 mm

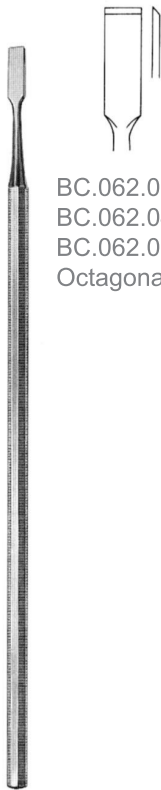

BC.062.03 21,0 cm - 8 1/4" 3 mm
BC.062.04 21,0 cm - 8 1/4" 4 mm
BC.062.05 21,0 cm - 8 1/4" 5 mm
Octagonal handle

1/2

BC.062.03/05
Stout
Bone Chisels
and Gouges



BC.068.04
18,0 cm - 7"
4 mm
Octagonal handle

1/1

1/2

BC.068.04
Bone Chisels
and Gouges



BC.070.04
18,0 cm - 7"
4 mm
Octagonal handle

1/1

1/2

BC.070.04
Bone Chisels
and Gouges



BC.072.04
17,0 cm - 6 3/4"
4 mm

BC.072.04
Bone Chisels
and Gouges



BC.074.04
17,0 cm - 6 3/4"
4 mm

BC.074.04
Bone Chisels
and Gouges

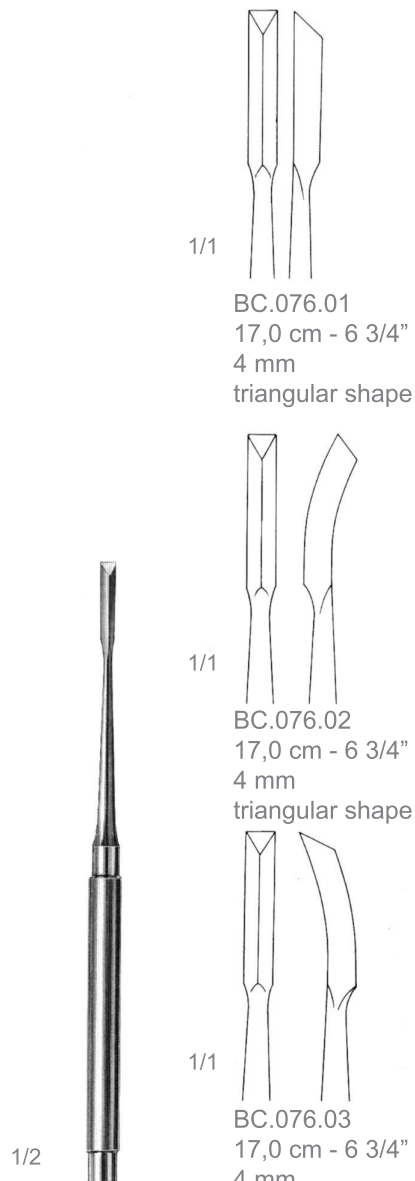

BC.076.01
17,0 cm - 6 3/4"
4 mm
triangular shape

BC.076.02
17,0 cm - 6 3/4"
4 mm
triangular shape

BC.076.03
17,0 cm - 6 3/4"
4 mm
triangular shape

BC.076.01/03
Gardner
Bone Chisels
and Gouges

BC

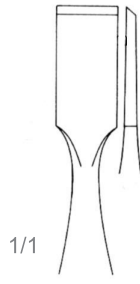

BC.082.01
17,0 cm - 6 3/4"
3 mm

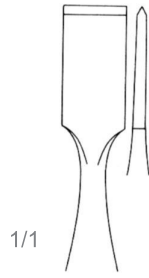

BC.084.01
17,0 cm - 6 3/4"
9 mm

BC.082.01
BC.084.01
O.S.U.
Bone Chisels
and Gouges

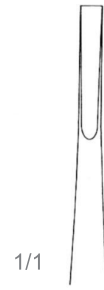

BC.080.03
16,5 cm - 6 1/2"
3 mm



BC.080.05
16,5 cm - 6 1/2"
5 mm

BC.080.03/05
Snyder-O.S.U.
Bone Chisels
and Gouges



BC.100.08 13,5 cm - 5 1/4" 8 mm
BC.100.10 13,5 cm - 5 1/4" 10 mm
BC.100.12 13,5 cm - 5 1/4" 12 mm
BC.100.14 13,5 cm - 5 1/4" 14 mm
BC.100.16 13,5 cm - 5 1/4" 16 mm

1/2

BC.100.08/16
Bone Chisels
and Gouges

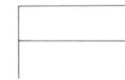

BC.101.08 13,5 cm - 5 1/4" 8 mm
BC.101.10 13,5 cm - 5 1/4" 10 mm
BC.101.12 13,5 cm - 5 1/4" 12 mm
BC.101.14 13,5 cm - 5 1/4" 14 mm
BC.101.16 13,5 cm - 5 1/4" 16 mm

1/2

BC.101.08/16
Bone Chisels
and Gouges



BC.102.08	13,5 cm - 5 1/4"	8 mm
BC.102.10	13,5 cm - 5 1/4"	10 mm
BC.102.12	13,5 cm - 5 1/4"	12 mm
BC.102.14	13,5 cm - 5 1/4"	14 mm
BC.102.16	13,5 cm - 5 1/4"	16 mm

1/2

BC.102.08/16
Bone Chisels
and Gouges

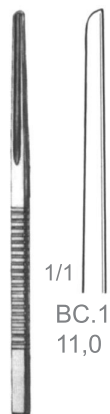

1/1
BC.103.01
11,0 cm - 4 1/2"

1/2

BC.103.01
Buck-Gramcko
Bone Chisels
and Gouges



1/1
BC.103.02
11,0 cm - 4 1/2"

1/2

BC.103.02
Buck-Gramcko
Bone Chisels
and Gouges

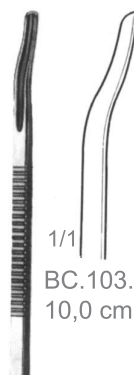

1/1
BC.103.03
10,0 cm - 4"

1/2

BC.103.03
Buck-Gramcko
Bone Chisels
and Gouges

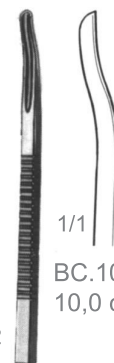

1/1
BC.103.04
10,0 cm - 4"

1/2

BC.103.04
Buck-Gramcko
Bone Chisels
and Gouges

BC



1/2



BC.105.02	13,5 cm - 5 1/4"	2 mm
BC.105.03	13,5 cm - 5 1/4"	3 mm
BC.105.04	13,5 cm - 5 1/4"	4 mm
BC.105.05	13,5 cm - 5 1/4"	5 mm
BC.105.06	13,5 cm - 5 1/4"	6 mm

BC.106.02	17,0 cm - 6 3/4"	2 mm
BC.106.03	17,0 cm - 6 3/4"	3 mm
BC.106.04	17,0 cm - 6 3/4"	4 mm
BC.106.05	17,0 cm - 6 3/4"	5 mm
BC.106.06	17,0 cm - 6 3/4"	6 mm

BC.105.02/06
BC.106.02/06

Partsch
Bone Chisels
and Gouges



1/2



BC.109.02	13,5 cm - 5 1/4"	2 mm
BC.109.03	13,5 cm - 5 1/4"	3 mm
BC.109.04	13,5 cm - 5 1/4"	4 mm
BC.109.05	13,5 cm - 5 1/4"	5 mm
BC.109.06	13,5 cm - 5 1/4"	6 mm

BC.110.02	17,0 cm - 6 3/4"	2 mm
BC.110.03	17,0 cm - 6 3/4"	3 mm
BC.110.04	17,0 cm - 6 3/4"	4 mm
BC.110.05	17,0 cm - 6 3/4"	5 mm
BC.110.06	17,0 cm - 6 3/4"	6 mm

BC.109.02/06
BC.110.02/06

Partsch
Bone Chisels
and Gouges



1/2



BC.118.04	18,0 cm - 7"	4 mm
BC.118.06	18,0 cm - 7"	6 mm
BC.118.08	18,0 cm - 7"	8 mm
BC.118.10	18,0 cm - 7"	10 mm
BC.118.12	18,0 cm - 7"	12 mm
BC.118.14	18,0 cm - 7"	14 mm

BC.118.04/14
Alexander
Bone Chisels
and Gouges



1/2



BC.119.04	18,0 cm - 7"	4 mm
BC.119.06	18,0 cm - 7"	6 mm
BC.119.08	18,0 cm - 7"	8 mm
BC.119.10	18,0 cm - 7"	10 mm
BC.119.12	18,0 cm - 7"	12 mm
BC.119.14	18,0 cm - 7"	14 mm

BC.119.04/14
Alexander
Bone Chisels
and Gouges



BC.123.10	20,0 cm - 8"	10 mm
BC.123.15	20,0 cm - 8"	15 mm
BC.123.20	20,0 cm - 8"	20 mm
BC.123.25	20,0 cm - 8"	25 mm

BC.123.10/25
Stille
Bone Chisels
and Gouges

1/2



BC.124.10	20,0 cm - 8"	10 mm
BC.124.15	20,0 cm - 8"	15 mm
BC.124.20	20,0 cm - 8"	20 mm
BC.124.25	20,0 cm - 8"	25 mm

BC.124.10/25
Stille
Bone Chisels
and Gouges

1/2



BC.127.10	20,0 cm - 8"	10 mm
BC.127.15	20,0 cm - 8"	15 mm
BC.127.20	20,0 cm - 8"	20 mm
BC.127.25	20,0 cm - 8"	25 mm

BC.127.10/25
Stille
Bone Chisels
and Gouges

1/2

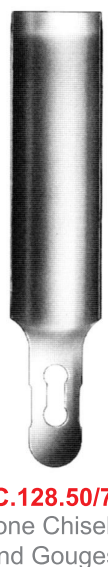

BC.128.50	r = 50 mm
BC.128.60	r = 60 mm
BC.128.70	r = 70 mm

Interchangeable chisel
blades, hollow

BC.128.50/70
Bone Chisels
and Gouges

BC

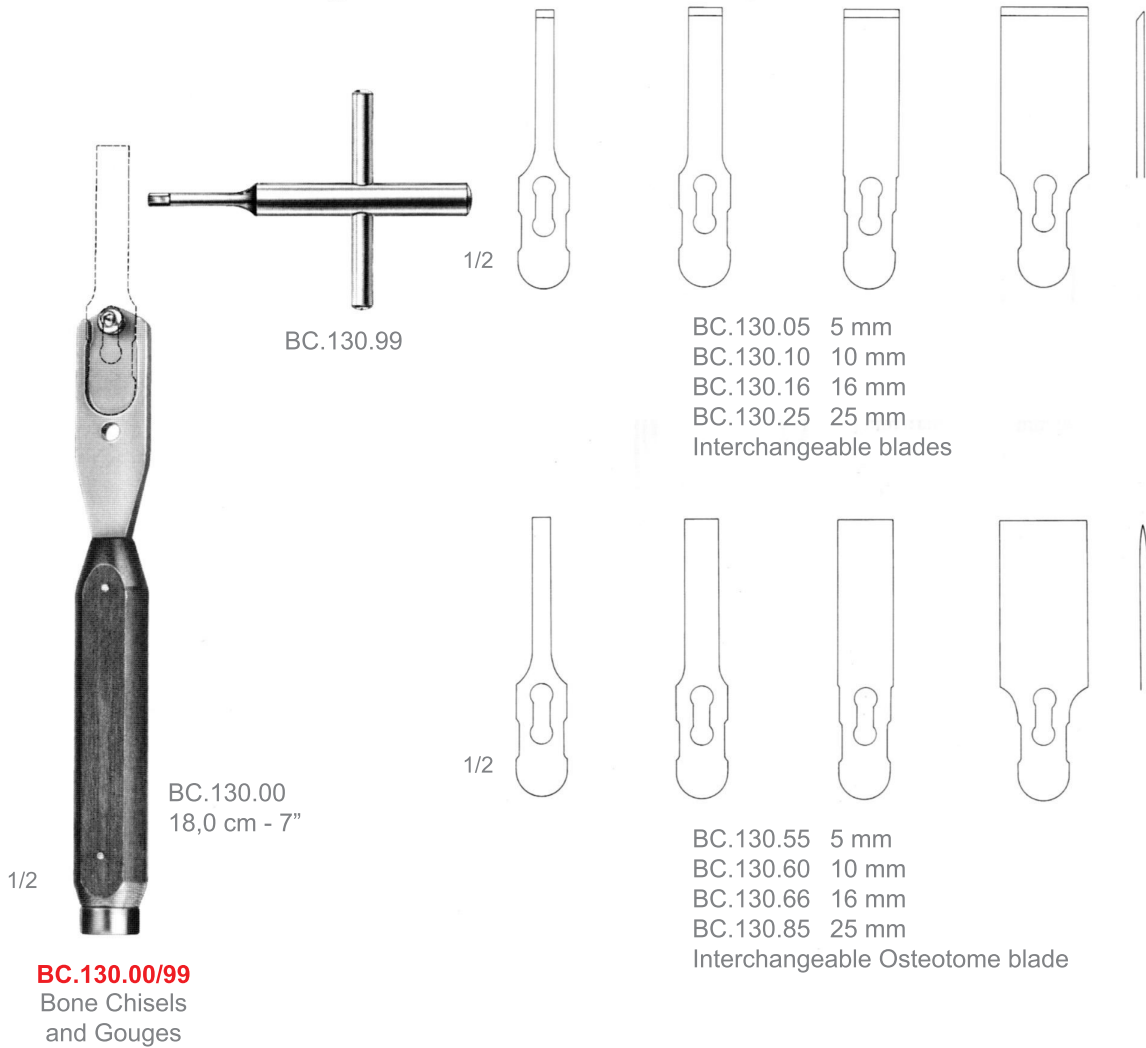

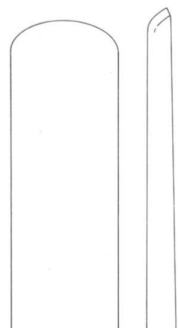

BC.131.05 25,0 cm - 10" 5 mm
BC.131.10 25,0 cm - 10" 10 mm
BC.131.15 25,0 cm - 10" 15 mm
Handle from artificial wood



1/2

BC.131.05/15

Lexer
Spongiosa Chisels
Bone Chisels
and Gouges

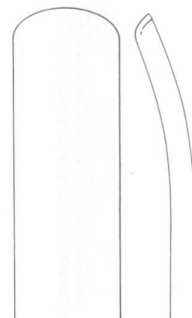

BC.131.55 25,0 cm - 10" 5 mm
BC.131.60 25,0 cm - 10" 10 mm
BC.131.65 25,0 cm - 10" 15 mm
Handle from artificial wood



1/2

BC.131.55/65

Lexer
Spongiosa Chisels
Bone Chisels
and Gouges

BC



1/2

BC.132.04 18,0 cm - 7" 4 mm
BC.132.06 18,0 cm - 7" 6 mm
BC.132.08 18,0 cm - 7" 8 mm
BC.132.10 18,0 cm - 7" 10 mm
BC.132.12 18,0 cm - 7" 12 mm
Handle from artificial wood

BC.132.04/12
Mini-Lexer
Bone Chisels
and Gouges



1/2

BC.133.04 18,0 cm - 7" 4 mm
BC.133.06 18,0 cm - 7" 6 mm
BC.133.08 18,0 cm - 7" 8 mm
BC.133.10 18,0 cm - 7" 10 mm
BC.133.12 18,0 cm - 7" 12 mm
Handle from artificial wood

BC.133.04/12
Mini-Lexer
Bone Chisels
and Gouges

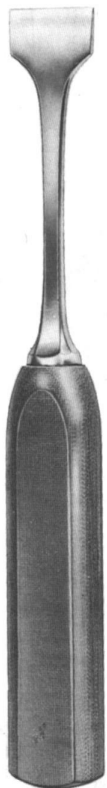

1/2

BC.134.07 22,0 cm - 8 3/4" 7 mm
BC.134.10 22,0 cm - 8 3/4" 10 mm
BC.134.15 22,0 cm - 8 3/4" 15 mm
BC.134.20 22,0 cm - 8 3/4" 20 mm
BC.134.25 22,0 cm - 8 3/4" 25 mm
BC.134.30 22,0 cm - 8 3/4" 30 mm
Handle from artificial wood

BC.134.07/30
Lexer
Bone Chisels
and Gouges



1/2

BC.135.07 22,0 cm - 8 3/4" 7 mm
BC.135.10 22,0 cm - 8 3/4" 10 mm
BC.135.15 22,0 cm - 8 3/4" 15 mm
BC.135.20 22,0 cm - 8 3/4" 20 mm
BC.135.25 22,0 cm - 8 3/4" 25 mm
BC.135.30 22,0 cm - 8 3/4" 30 mm
Handle from artificial wood

BC.135.07/30
Lexer
Bone Chisels
and Gouges

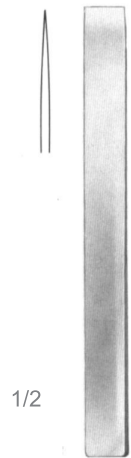

BC.136.03	12,5 cm - 5"	3 mm
BC.136.04	12,5 cm - 5"	4 mm
BC.136.06	12,5 cm - 5"	6 mm
BC.136.08	12,5 cm - 5"	8 mm
BC.136.10	12,5 cm - 5"	10 mm
BC.136.12	12,5 cm - 5"	12 mm
BC.136.15	12,5 cm - 5"	15 mm

BC.136.03/15
Mini-Lambotte
Bone Chisels
and Gouges



BC.136.53	17,0 cm - 6 3/4"	3 mm
BC.136.54	17,0 cm - 6 3/4"	4 mm
BC.136.56	17,0 cm - 6 3/4"	6 mm
BC.136.58	17,0 cm - 6 3/4"	8 mm
BC.136.60	17,0 cm - 6 3/4"	10 mm
BC.136.62	17,0 cm - 6 3/4"	12 mm
BC.136.65	17,0 cm - 6 3/4"	15 mm

BC.136.53/65
Mini-Lambotte
Bone Chisels
and Gouges



BC.138.15	24,0 cm - 9 1/2"	15 mm
BC.138.20	24,0 cm - 9 1/2"	20 mm
BC.138.25	24,0 cm - 9 1/2"	25 mm
BC.138.30	24,0 cm - 9 1/2"	30 mm
BC.138.38	24,0 cm - 9 1/2"	38 mm
BC.138.44	24,0 cm - 9 1/2"	44 mm
BC.138.50	24,0 cm - 9 1/2"	50 mm

BC.138.15/50
Lambotte
Bone Chisels
and Gouges

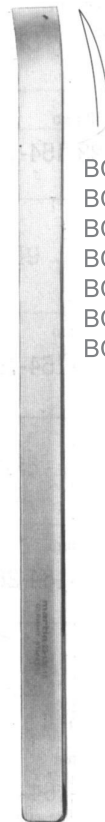

BC.139.15	23,0 cm - 9"	15 mm
BC.139.20	23,0 cm - 9"	20 mm
BC.139.25	23,0 cm - 9"	25 mm
BC.139.30	23,0 cm - 9"	30 mm
BC.139.38	23,0 cm - 9"	38 mm
BC.139.44	23,0 cm - 9"	44 mm
BC.139.50	23,0 cm - 9"	50 mm

BC.139.15/50
Lambotte
Bone Chisels
and Gouges

Kolpen

BONE SURGERY
KNOCHENCHIRURGIE
CIRUGÍA OSEA

Bone Chisels and Gouges

MEIBEL UND OSTEOTOME - CINCELES Y GUBIAS PARA HUESOS

BC

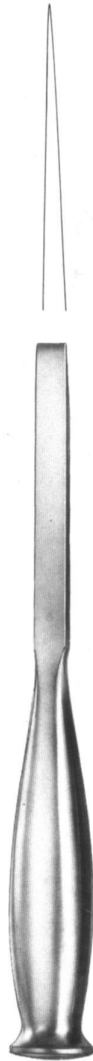

1/2

BC.154.06/32
Smith-Petersen
Bone Chisels
and Gouges

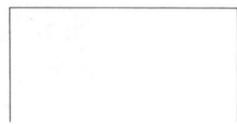

BC.154.06	20,0 cm - 8"	6 mm
BC.154.09	20,0 cm - 8"	9 mm
BC.154.13	20,0 cm - 8"	13 mm
BC.154.16	20,0 cm - 8"	16 mm
BC.154.19	20,0 cm - 8"	19 mm
BC.154.25	20,0 cm - 8"	25 mm
BC.154.32	20,0 cm - 8"	32 mm

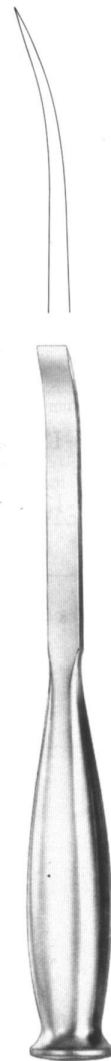

1/2

BC.155.06/32
Smith-Petersen
Bone Chisels
and Gouges

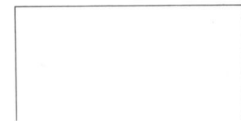

BC.155.06	20,0 cm - 8"	6 mm
BC.155.09	20,0 cm - 8"	9 mm
BC.155.13	20,0 cm - 8"	13 mm
BC.155.16	20,0 cm - 8"	16 mm
BC.155.19	20,0 cm - 8"	19 mm
BC.155.25	20,0 cm - 8"	25 mm
BC.155.32	20,0 cm - 8"	32 mm



BC.156.09 20,0 cm - 8" 9 mm
 BC.156.14 20,0 cm - 8" 14 mm
 BC.156.19 20,0 cm - 8" 19 mm
 BC.156.25 20,0 cm - 8" 25 mm



1/2

BC.156.09/25
Smith-Petersen
Bone Chisels
and Gouges



BC.157.09 20,0 cm - 8" 9 mm
 BC.157.14 20,0 cm - 8" 14 mm
 BC.157.19 20,0 cm - 8" 19 mm
 BC.157.25 20,0 cm - 8" 25 mm

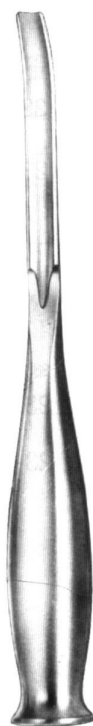

1/2

BC.157.09/25
Smith-Petersen
Bone Chisels
and Gouges

BC



- BC.162.03 17,0 cm - 6 3/4" 3 mm
- BC.162.05 17,0 cm - 6 3/4" 5 mm
- BC.162.06 17,0 cm - 6 3/4" 6 mm
- BC.162.08 17,0 cm - 6 3/4" 8 mm
- BC.162.09 17,0 cm - 6 3/4" 9 mm

BC.162.03/09
Hoke
Bone Chisels
and Gouges



- BC.170.06 24,0 cm - 9 1/2" 6 mm
- BC.170.13 24,0 cm - 9 1/2" 13 mm
- BC.170.19 24,0 cm - 9 1/2" 19 mm
- BC.170.25 24,0 cm - 9 1/2" 25 mm
- BC.170.32 24,0 cm - 9 1/2" 32 mm

1/2

BC.170.06/32
Hibbs
Bone Chisels
and Gouges

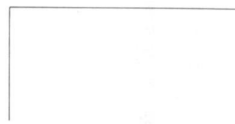

- BC.172.06 24,0 cm - 9 1/2" 6 mm
- BC.172.13 24,0 cm - 9 1/2" 13 mm
- BC.172.19 24,0 cm - 9 1/2" 19 mm
- BC.172.25 24,0 cm - 9 1/2" 25 mm
- BC.172.32 24,0 cm - 9 1/2" 32 mm

1/2

BC.172.06/32
Hibbs
Bone Chisels
and Gouges

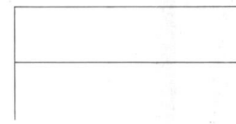

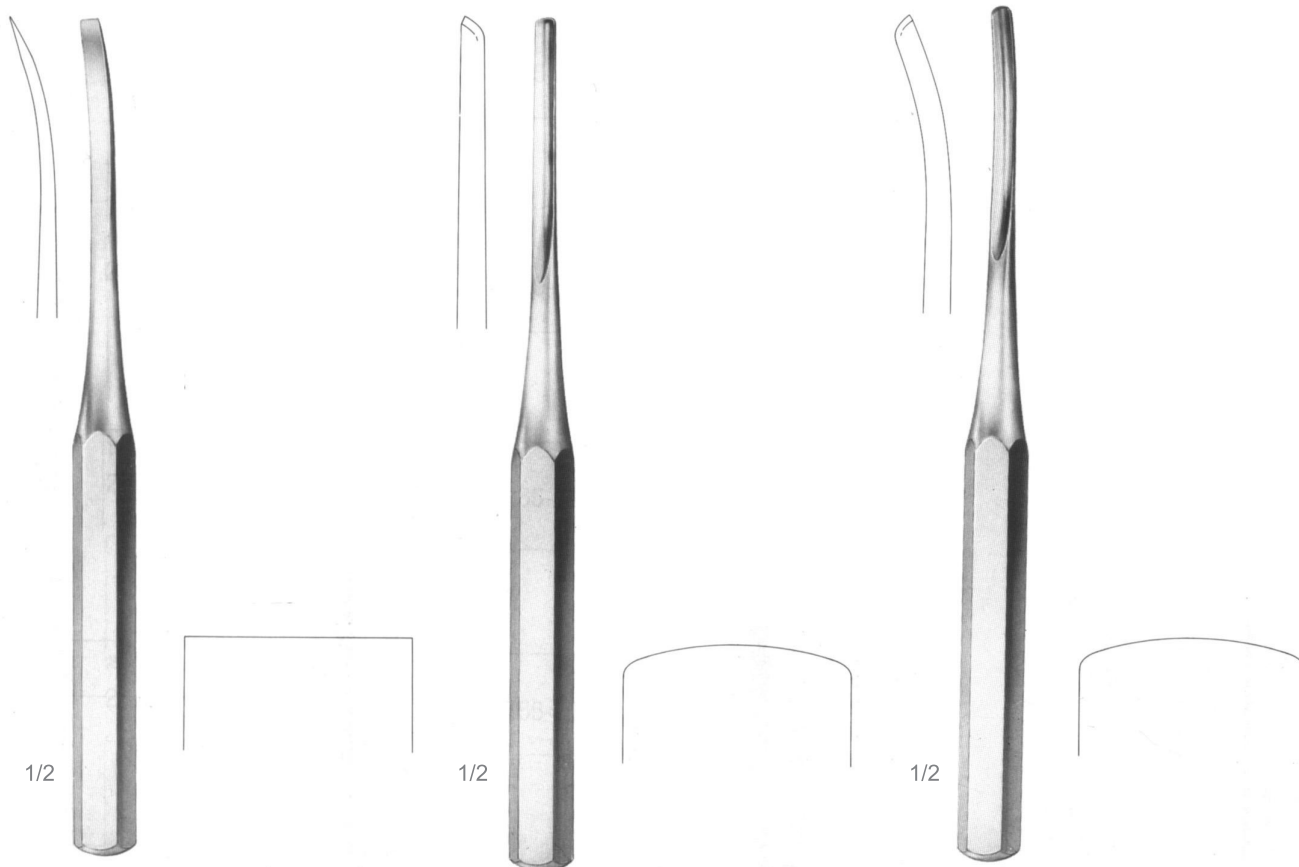

BC.173.06/32

Hibbs
Bone Chisels
and Gouges

BC.176.06/32

Hibbs
Bone Chisels
and Gouges

BC.177.06/32

Hibbs
Bone Chisels
and Gouges

BC.173.06	24,0 cm - 9 1/2"	6 mm
BC.173.13	24,0 cm - 9 1/2"	13 mm
BC.173.19	24,0 cm - 9 1/2"	19 mm
BC.173.25	24,0 cm - 9 1/2"	25 mm
BC.172.32	24,0 cm - 9 1/2"	32 mm

BC.173.06	24,0 cm - 9 1/2"	6 mm
BC.173.13	24,0 cm - 9 1/2"	13 mm
BC.173.19	24,0 cm - 9 1/2"	19 mm
BC.173.25	24,0 cm - 9 1/2"	25 mm
BC.172.32	24,0 cm - 9 1/2"	32 mm

BC.173.06	24,0 cm - 9 1/2"	6 mm
BC.173.13	24,0 cm - 9 1/2"	13 mm
BC.173.19	24,0 cm - 9 1/2"	19 mm
BC.173.25	24,0 cm - 9 1/2"	25 mm
BC.172.32	24,0 cm - 9 1/2"	32 mm

BC



BC.181.30
30,0 cm - 12"

1/2

BC.181.30
Putti
Hemostats



1/2



1/1

BC.183.27
Putti
Hemostats

BC.183.27
27,0 cm - 10 1/2"



BC.198.02	15,5 cm - 6"	2 mm Ø
BC.198.03	15,5 cm - 6"	3 mm Ø
BC.198.04	15,5 cm - 6"	4 mm Ø
BC.198.05	15,5 cm - 6"	5 mm Ø
BC.198.06	15,5 cm - 6"	6 mm Ø
BC.198.08	15,5 cm - 6"	8 mm Ø
BC.198.10	15,5 cm - 6"	10 mm Ø

BC.198.02/10
Hemostats



BC.191.10
18,0 cm - 7"

1/2

BC.191.10
Vickers
Hemostats

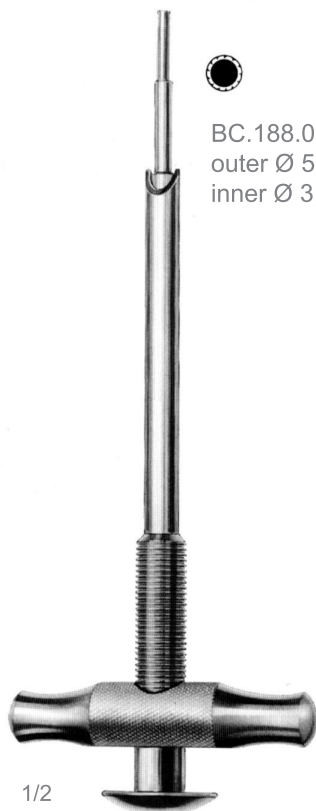

BC.188.00
outer Ø 5,0 mm
inner Ø 3,8 mm

1/2

BC.188.00
Champy-OSU
Bone Biopsy
Instruments

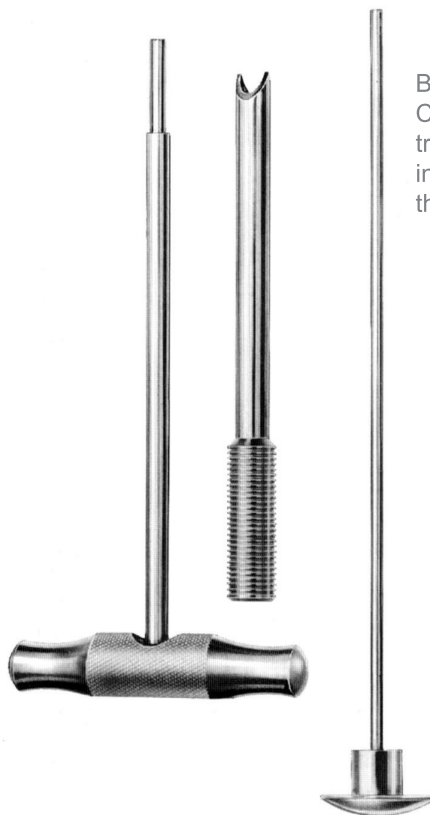

BC.188.00
Consisting of trocar, a toothed
trephine and a plunger for tak-
ing tibial and iliac bone grafts
through a closed technique

BC

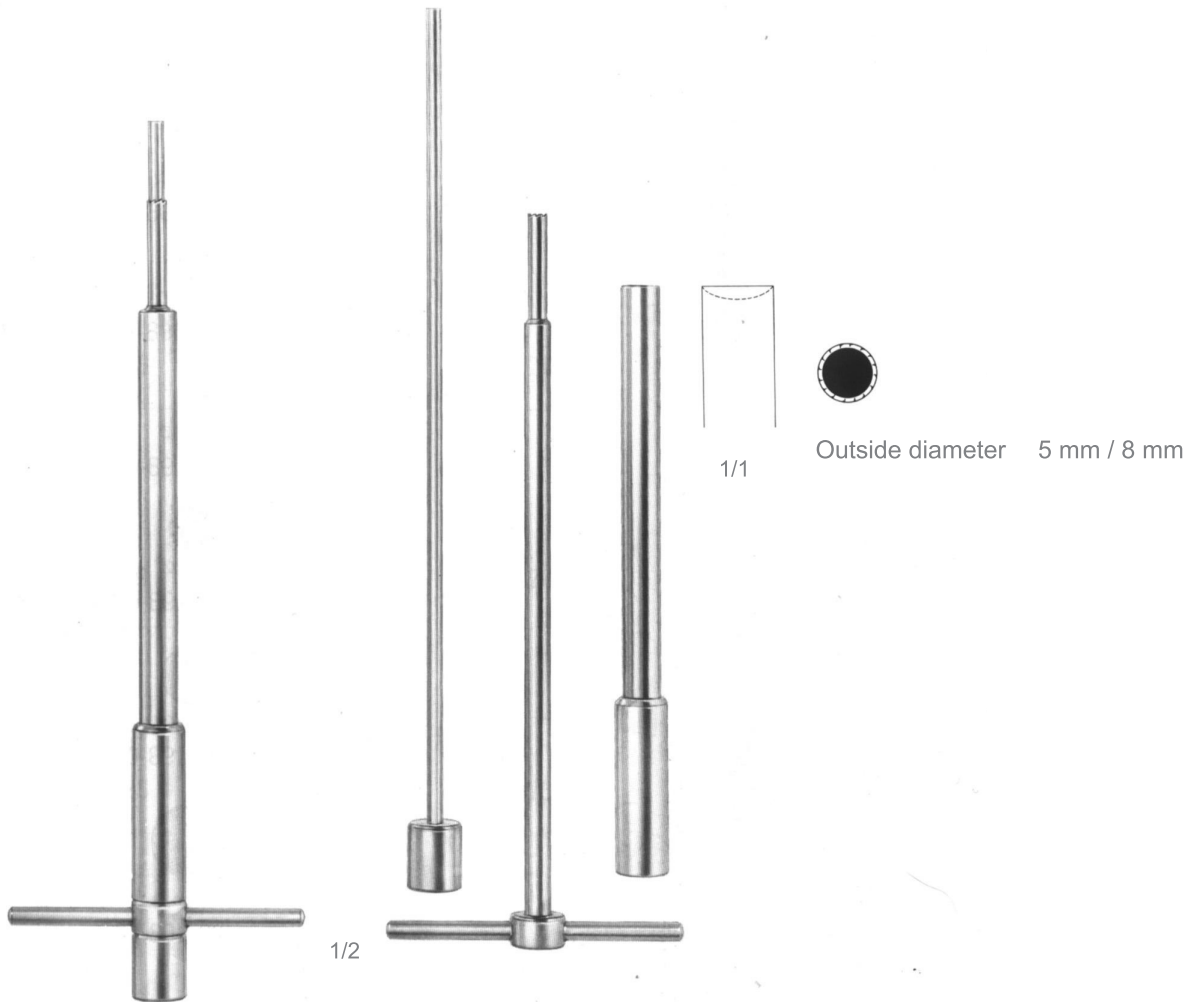

BC.190.01/02
Champy-OSU
Bone Biopsy
Instruments

BC.190.01 Bone Biopsy Trephine for
Iliac Crest, modif. by
Champy, outside diameter 8 mm

BC.190.02 ditto, but outside diameter 5 mm



1/3

BC.190.05
Bone Biopsy
Instruments

BC.188.00
22,5 cm - 8 3/4"
outer Ø 17,0 mm
inner Ø 16,0 mm

Kolpen

Mallets

BONE SURGERY
KNOCHENCHIRURGIE
CIRUGÍA OSEA

HÄMMER - MARTILLOS Y MAZOS

BC

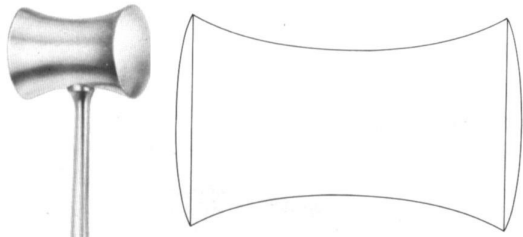

BC.200.01 24,0 cm - 9 1/2" 26 mm Ø
300 g (10 1/2 oz.)

BC.200.02 24,0 cm - 9 1/2" 28 mm Ø
340 g (12 oz.)

BC.200.03 24,0 cm - 9 1/2" 30 mm Ø
400 g (14 oz.)

BC.200.01/03

Williger
Mallets

1/2

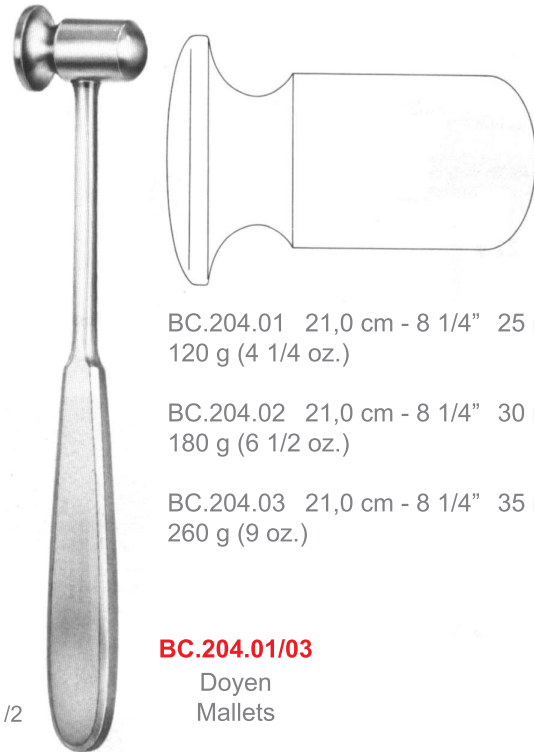

BC.204.01 21,0 cm - 8 1/4" 25 mm Ø
120 g (4 1/4 oz.)

BC.204.02 21,0 cm - 8 1/4" 30 mm Ø
180 g (6 1/2 oz.)

BC.204.03 21,0 cm - 8 1/4" 35 mm Ø
260 g (9 oz.)

BC.204.01/03

Doyen
Mallets

1/2

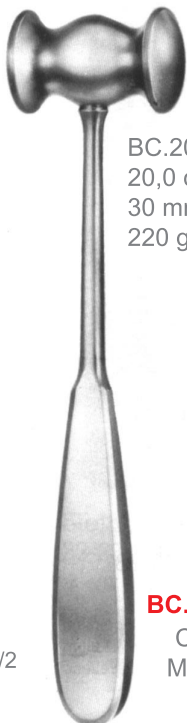

BC.208.20
20,0 cm - 8"
30 mm Ø
220 g (7 3/4 oz.)

BC.208.20

Collin
Mallets

1/2

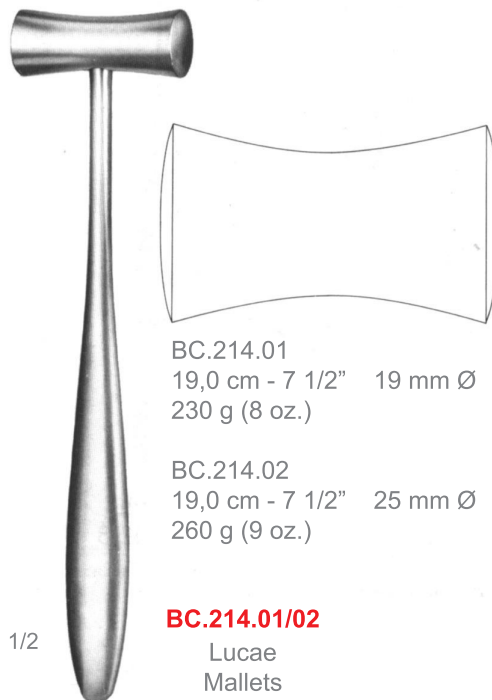

BC.214.01
19,0 cm - 7 1/2" 19 mm Ø
230 g (8 oz.)

BC.214.02
19,0 cm - 7 1/2" 25 mm Ø
260 g (9 oz.)

BC.214.01/02

Lucae
Mallets

1/2



BC.215.19
19,0 cm - 7 1/2"
30 mm Ø
300 g (10 1/2 oz.)
plane/convex

BC.215.19

Cottle
Mallets

1/2

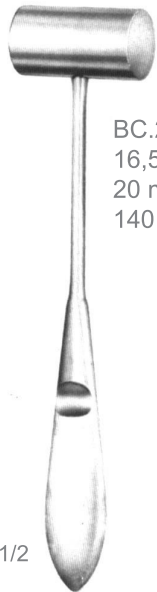

BC.216.01
16,5 cm - 6 1/2"
20 mm Ø
140 g (5 oz.)

1/2

BC.216.01
Mallets



BC.218.22
26,5 cm - 10 1/2"
30 mm Ø
510 g (18 oz.)

1/2

BC.218.22
Mallets

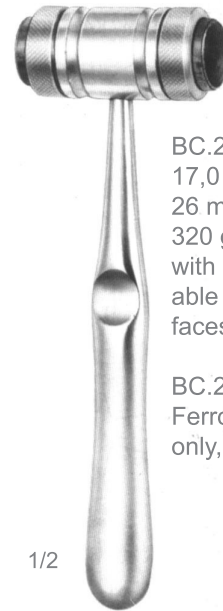

BC.220.17
17,0 cm - 6 3/4"
26 mm Ø
320 g (11 1/4 oz.)
with interchangeable
Ferrozell
faces

1/2

BC.220.17
BC.221.00
Mallets

BC.221.00
Ferrozell Faces
only, pair

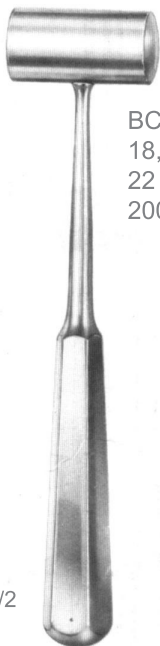

BC.224.18
18,0 cm - 7"
22 mm Ø
200 g (7 oz.)

1/2

BC.224.18
Partsch
Mallets

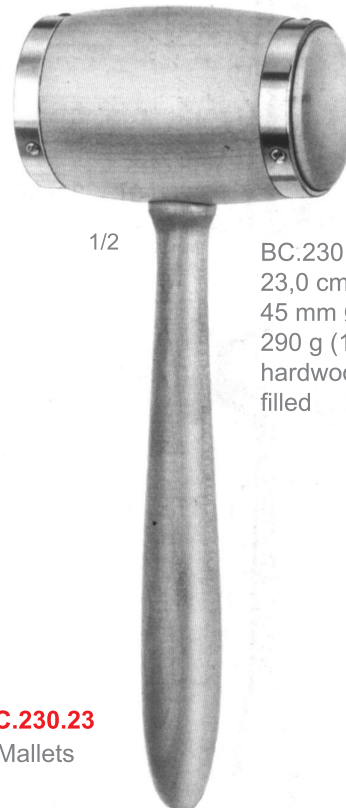

BC.230.23
23,0 cm - 9"
45 mm Ø
290 g (10 oz.)
hardwood, lead
filled

1/2

BC.230.23
Mallets

BC

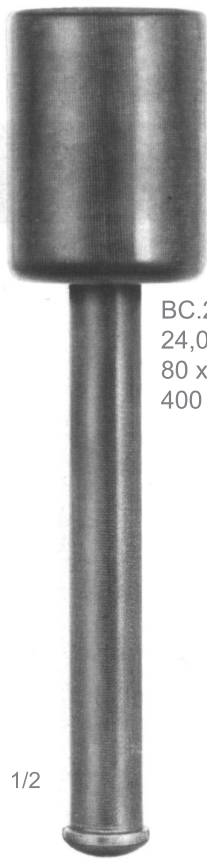

BC.234.24
24,0 cm - 9 1/2"
80 x 60 mm Ø
400 g

1/2

BC.234.24
Steinbach
Mallets

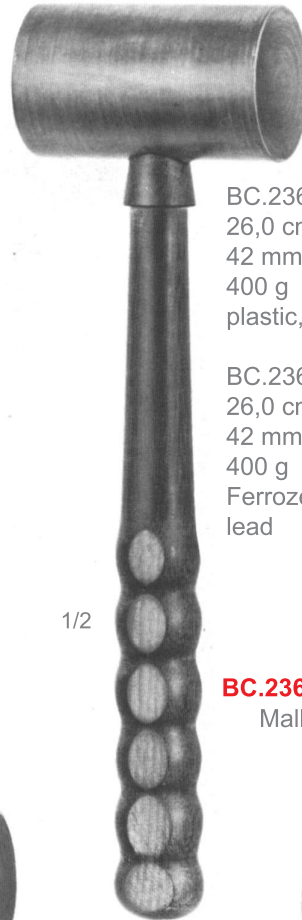

BC.236.01
26,0 cm - 10 1/4"
42 mm Ø
400 g
plastic, lead filled

1/2

BC.236.02
26,0 cm - 10 1/4"
42 mm Ø
400 g
Ferrozel, without
lead

BC.236.01/02
Mallets

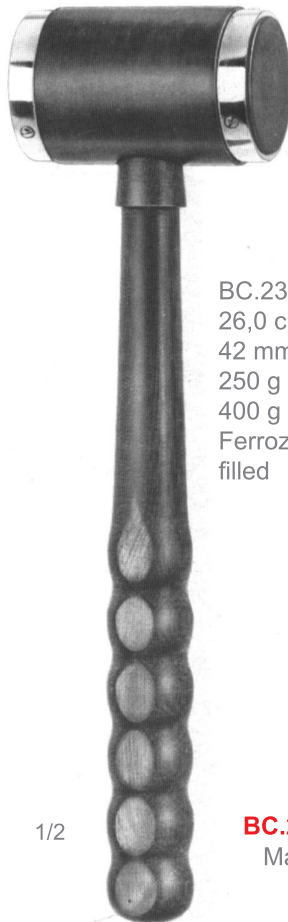

BC.238.26
26,0 cm - 10 1/4"
42 mm Ø
250 g
400 g
Ferrozel, lead
filled

1/2

BC.238.26
Mallets



BC.240.29
26,5 cm - 10 1/2"
repercussion free

1/2

BC.240.29
Mallets

Mallets

HÄMMER - MARTILLOS Y MAZOS

Kolpen

BONE SURGERY
KNOCHENCHIRURGIE
CIRUGÍA OSEA

BC

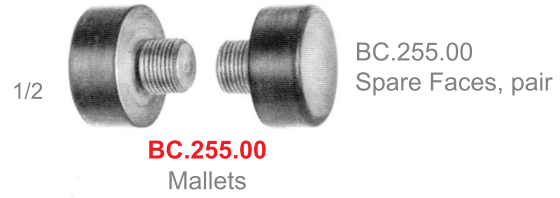

42 mm Ø 30 mm Ø



BC.242.24
Mallets

BC.242.24
26,5 cm - 10 1/2"
42/30 mm Ø
530 g (19 oz.)

steel, solid, with
plastic handle

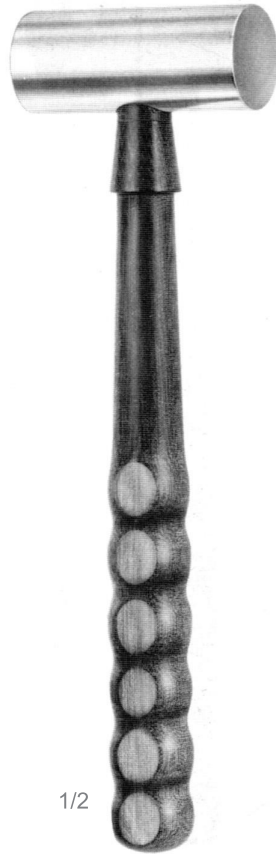

BC.244.24
Mallets

BC.244.24
24,0 cm - 9 1/2"
30 mm Ø
480 g

steel, solid, with
plastic handle

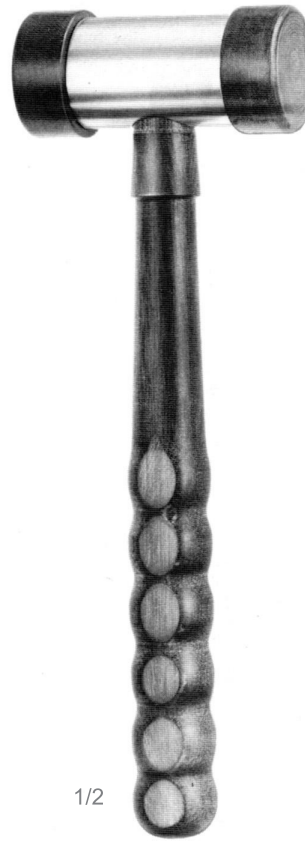

BC.254.22
Mallets

BC.254.22
22,5 cm - 9"
37 mm Ø
370 g

steel, solid, with
Ferozell faces

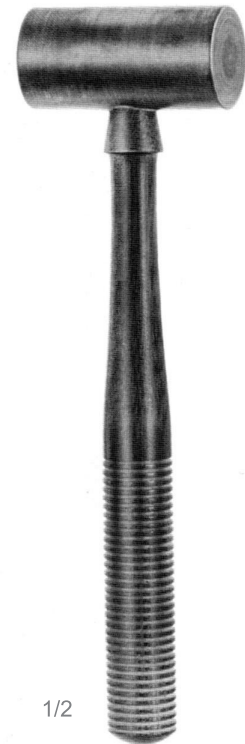

BC.256.18
Mallets

BC.256.18
18,0 cm - 7"
30 mm Ø
125 g (4 oz.)

Ferozell, solid

BC



BC.258.24
24,0 cm - 9 1/2"
steel, solid, with
plastic handle

BC.258.24
Mallets

1/2



BC.260.01
26,5 cm - 10 1/2"
450 g (1 lb.)
steel, solid

BC.260.01
Mallets

1/2



BC.260.02
26,5 cm - 10 1/2"
900 g (2 lb.)
steel, solid

BC.260.02
Mallets

1/2



BC.262.19
19,0 cm - 7 1/2"
25 mm Ø
300 g

nylon disks
plastic handle

BC.262.19
Vickers
Mallets

1/2

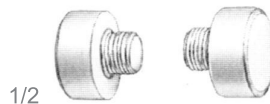

1/2

BC.262.90
Vickers
Mallets

BC.262.90
Spare Facing (pair)
plastic (nylon)



BC.262.19
19,0 cm - 7 1/2"
for ulnar head
prosthesis
plastic handle

BC.264.19
Herbert
Mallets

1/2

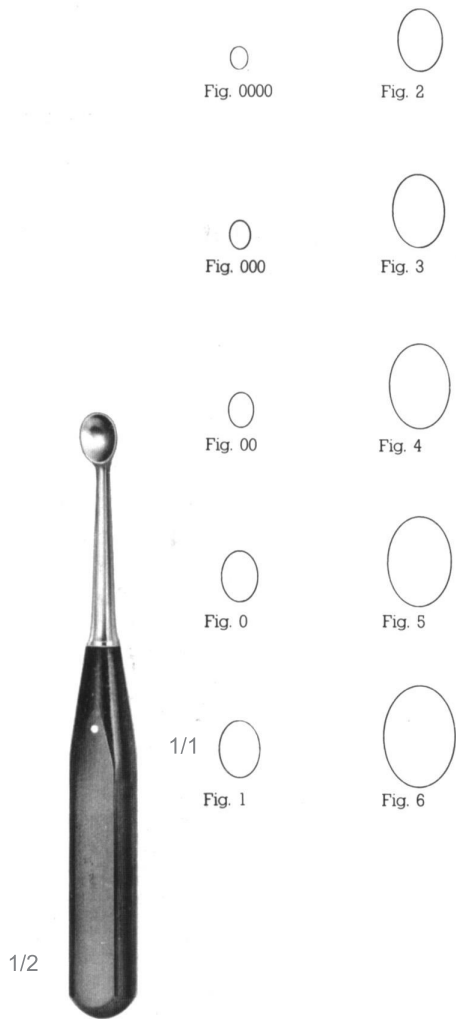

BC.280.06/40
Volkmann
Bone Curettes

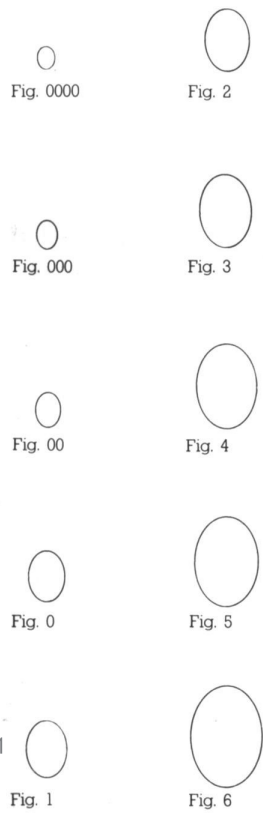
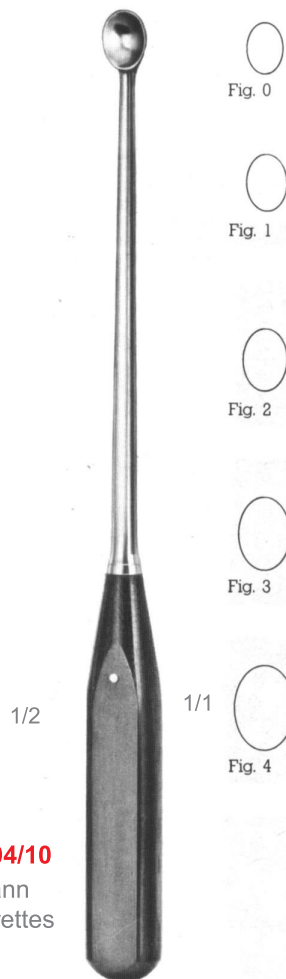

Fig. 0000	BC.280.40
Fig. 000	BC.280.30
Fig. 00	BC.280.20
Fig. 0	BC.280.10
Fig. 1	BC.280.01
Fig. 2	BC.280.02
Fig. 3	BC.280.03
Fig. 4	BC.280.04
Fig. 5	BC.280.05
Fig. 6	BC.280.06

17,0 cm - 6 3/4"
Handle from artificial wood



BC.282.04/10
Volkmann
Bone Curettes

Fig. 0	BC.282.10
Fig. 1	BC.282.01
Fig. 2	BC.282.02
Fig. 3	BC.282.03
Fig. 4	BC.282.04

27,0 cm - 10 3/4"
Handle from artificial wood

BC

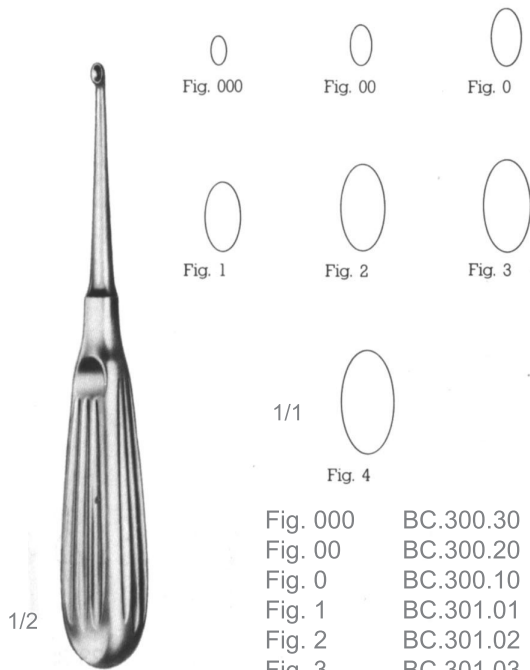

BC.300.10/30
BC.310.01/04
Schede
Bone Curettes

Fig. 000	BC.300.30
Fig. 00	BC.300.20
Fig. 0	BC.300.10
Fig. 1	BC.301.01
Fig. 2	BC.301.02
Fig. 3	BC.301.03
Fig. 4	BC.301.04

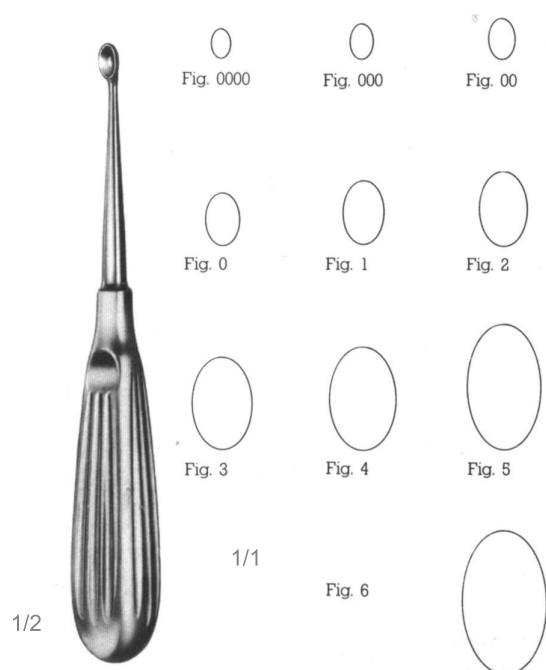

BC.304.10/40
Volkmann
Bone Curettes

Fig. 0000	BC.304.40
Fig. 000	BC.304.30
Fig. 00	BC.304.20
Fig. 0	BC.304.10
Fig. 1	BC.304.01
Fig. 2	BC.304.02
Fig. 3	BC.304.03
Fig. 4	BC.304.04
Fig. 5	BC.304.05
Fig. 6	BC.304.06

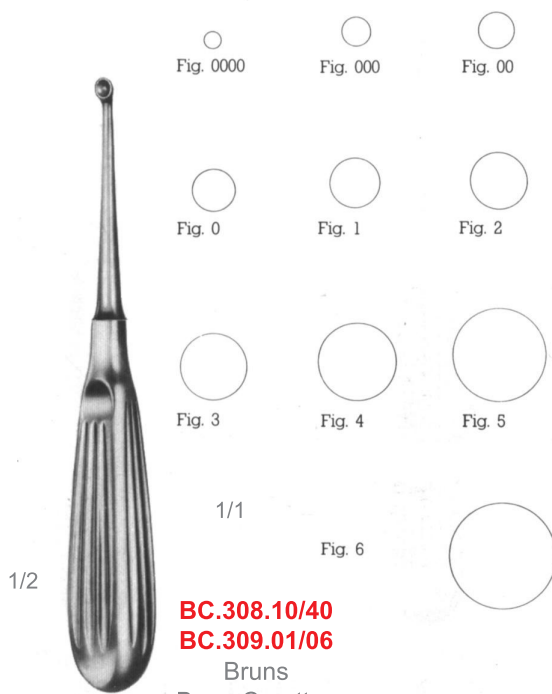

BC.308.10/40
BC.309.01/06
Bruns
Bone Curettes

Fig. 0000	BC.308.40
Fig. 000	BC.308.30
Fig. 00	BC.308.20
Fig. 0	BC.308.10
Fig. 1	BC.309.01
Fig. 2	BC.309.02
Fig. 3	BC.309.03
Fig. 4	BC.309.04
Fig. 5	BC.309.05
Fig. 6	BC.309.06

Bone Currettes

SCHARFE LÖFFEL - CUCHARILLAS CORTANTES

Kolpen

BONE SURGERY
KNOCHENCHIRURGIE
CIRUGÍA OSEA

BC

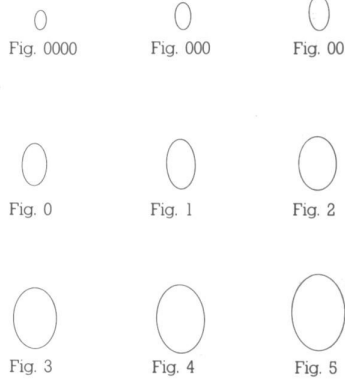
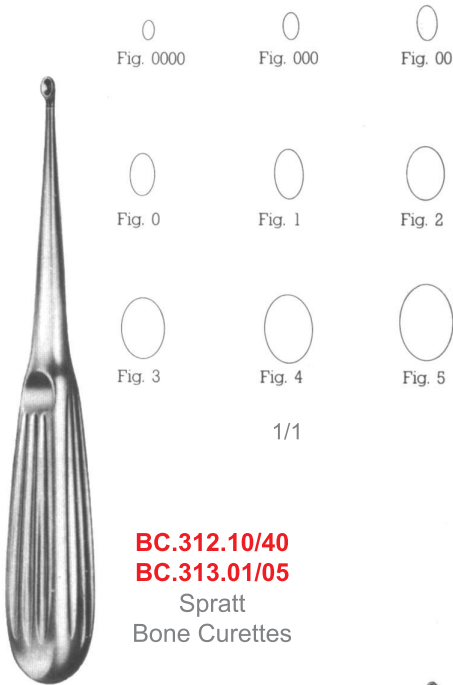
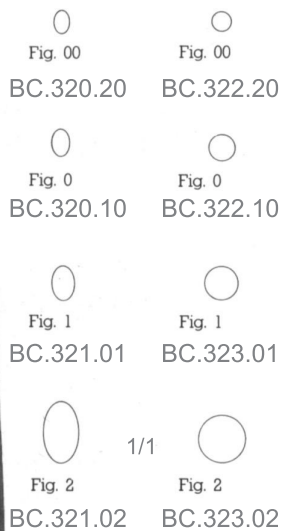
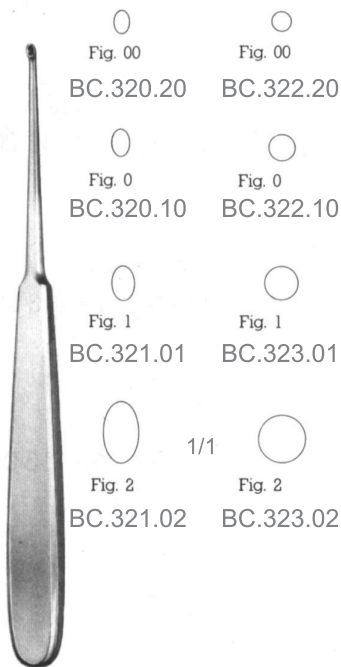

Fig. 0000	BC.312.40
Fig. 000	BC.312.30
Fig. 00	BC.312.20
Fig. 0	BC.312.10
Fig. 1	BC.313.01
Fig. 2	BC.313.02
Fig. 3	BC.313.03
Fig. 4	BC.313.04
Fig. 5	BC.313.05
Fig. 6	BC.313.06

BC.312.10/40
BC.313.01/05
Spratt
Bone Currettes

1/2



BC.320.10/20
BC.321.01/02
BC.322.10/20
BC.323.01/02

Williger
Bone Currettes

1/2

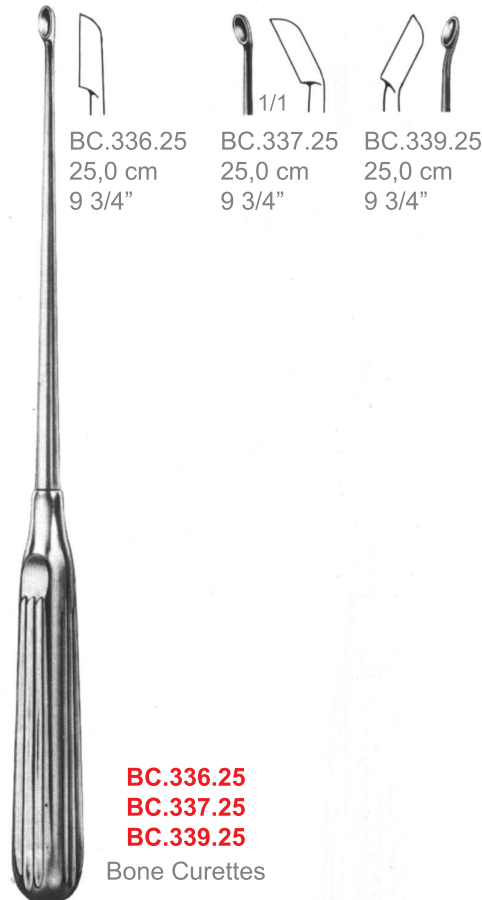

BC.336.25 25,0 cm 9 3/4"
BC.337.25 25,0 cm 9 3/4"
BC.339.25 25,0 cm 9 3/4"

BC.336.25
BC.337.25
BC.339.25
Bone Currettes

1/2

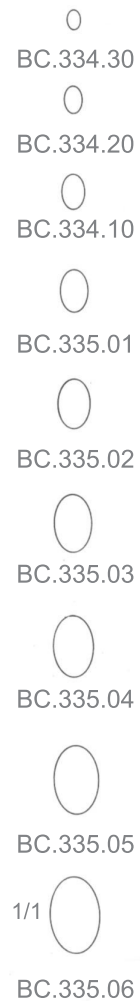
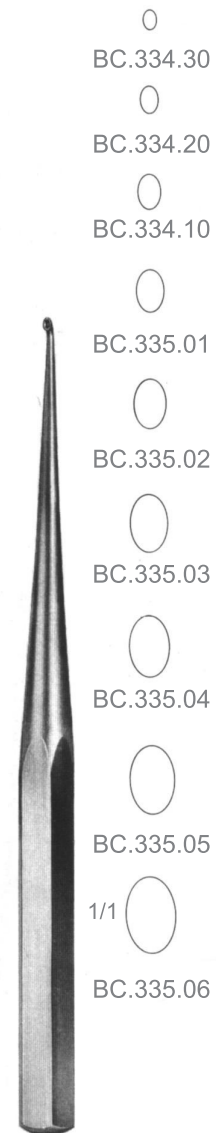

BC.334.10/30
BC.335.01/06
Bruns
Bone Currettes

1/2

BC

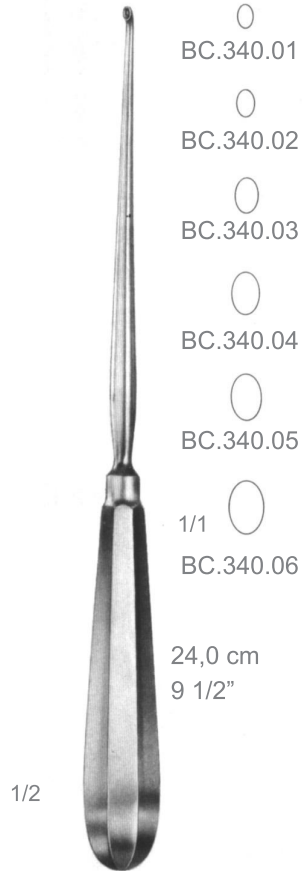

BC.340.01/06
Simon
Bone Curettes



BC.350.01/03
Simon
Bone Curettes

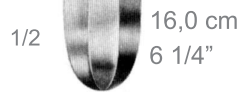
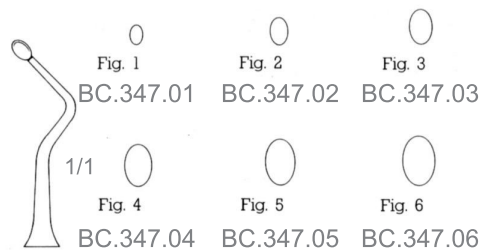
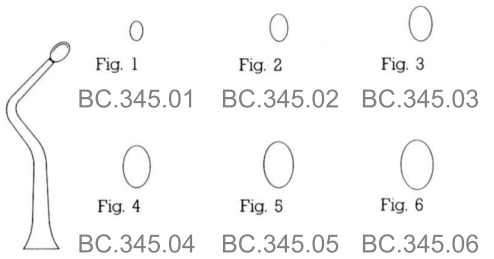
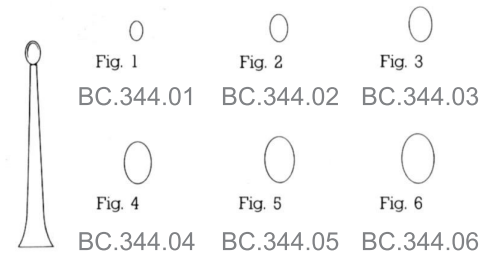

BC.344.01/06
BC.345.01/06
BC.347.01/06
Mod. USA
Bone Curettes

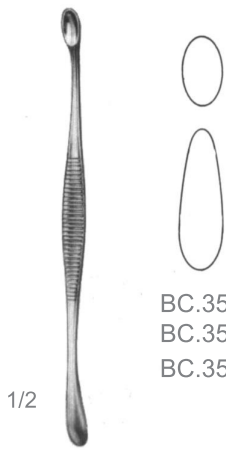

BC.352.13 13,0 cm - 5"
BC.352.14 14,0 cm - 5 1/2"
BC.352.17 17,0 cm - 6 3/4"

1/2

BC.352.13/17
Volkmann
Bone Curettes

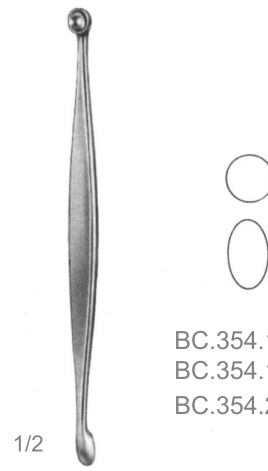

BC.354.13 13,0 cm - 5"
BC.354.16 16,0 cm - 6 1/4"
BC.354.20 20,0 cm - 8"

1/2

BC.354.13/20
Volkmann
Bone Curettes



BC.356.21
21,0 cm - 8 1/4"
oval/round

1/1

1/2

BC.356.21
Bone Curettes

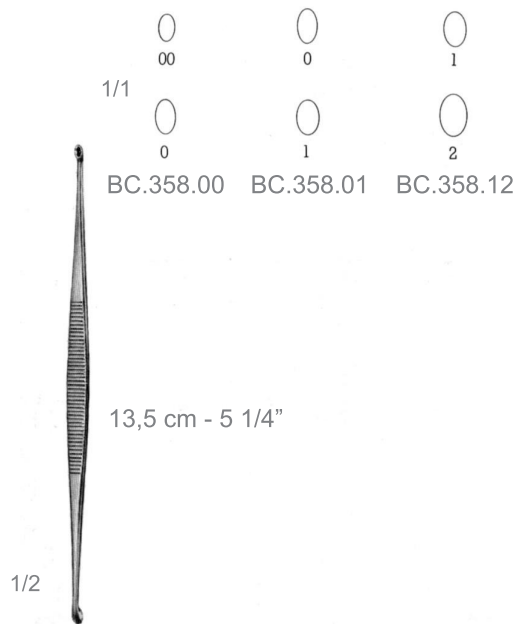

1/1

BC.358.00 BC.358.01 BC.358.12

13,5 cm - 5 1/4"

1/2

BC.358.00/12
Williger
Bone Curettes

BC

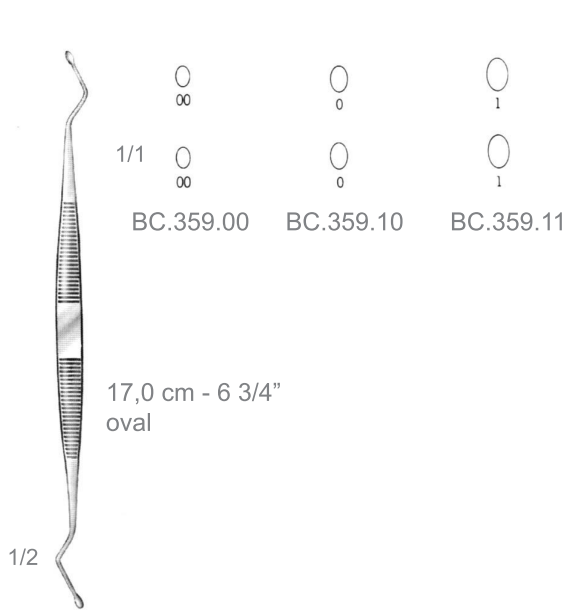

BC.359.00/11
Williger
Bone Curettes

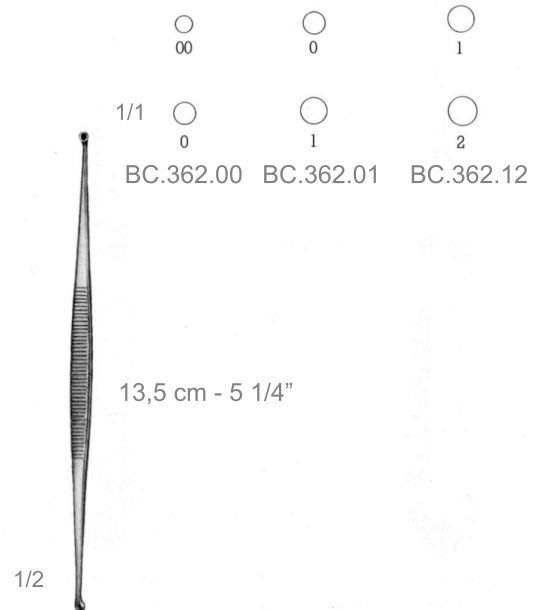

BC.362.00/12
Martini
Bone Curettes

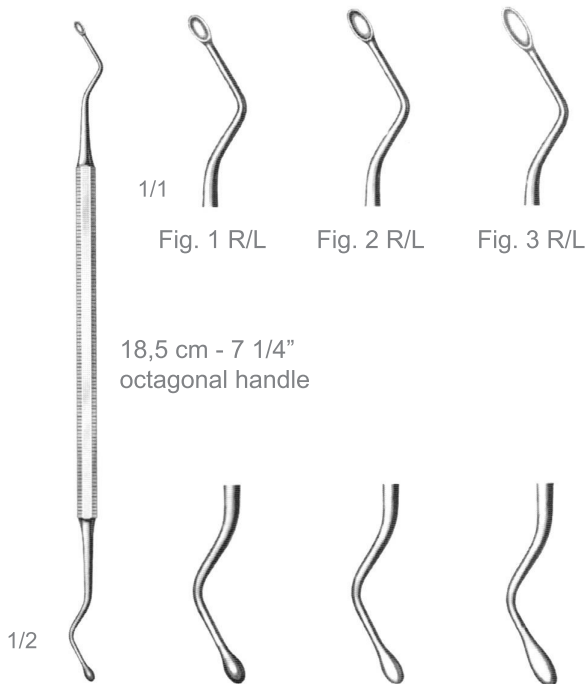

BC.371.11/33
Hemingway-Martin
Bone Curettes

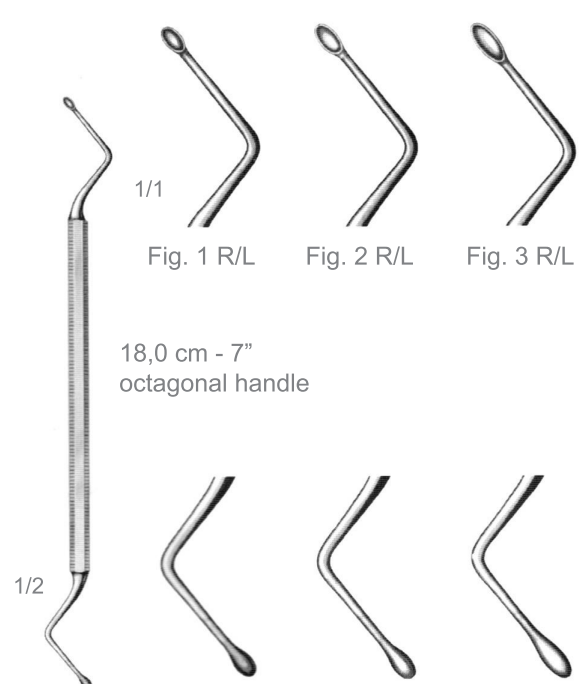

BC.373.11/33
Hemingway
Bone Curettes

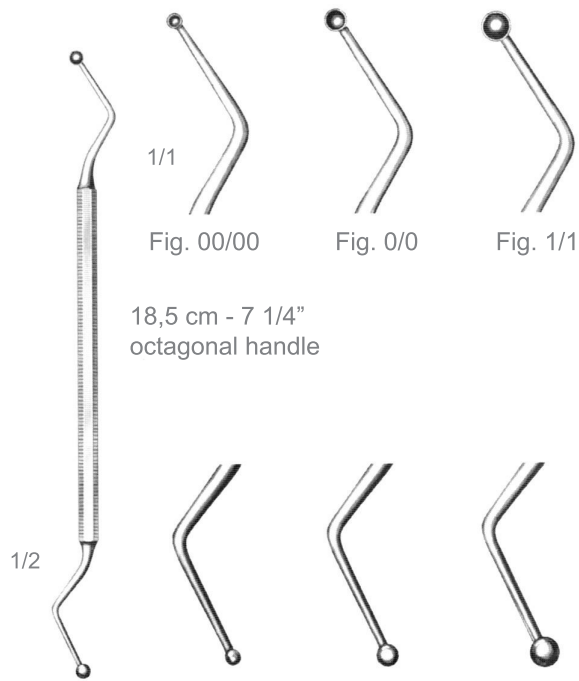

BC.375.00/11
Hemingway
Bone Curettes

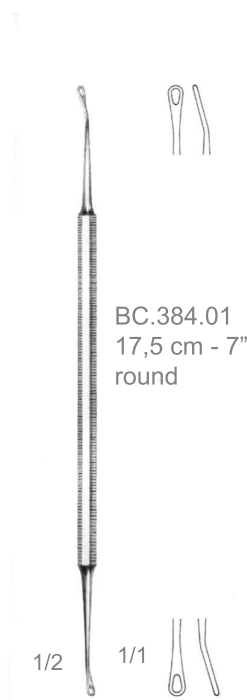

BC.384.01
Bone Curettes

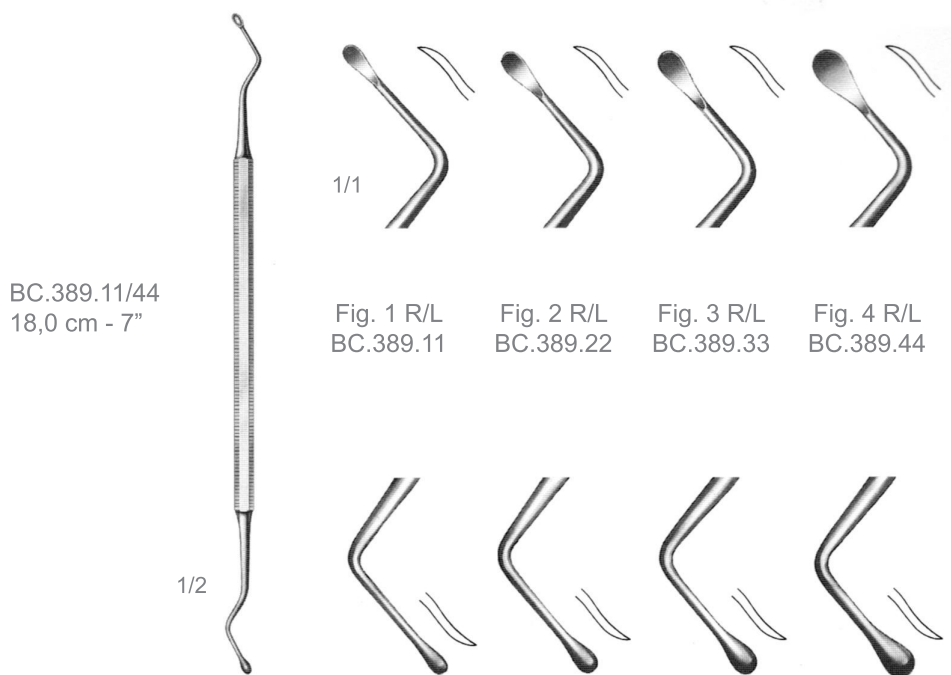

BC.389.11/44
Hemingway-Martin
Bone Curettes

BC

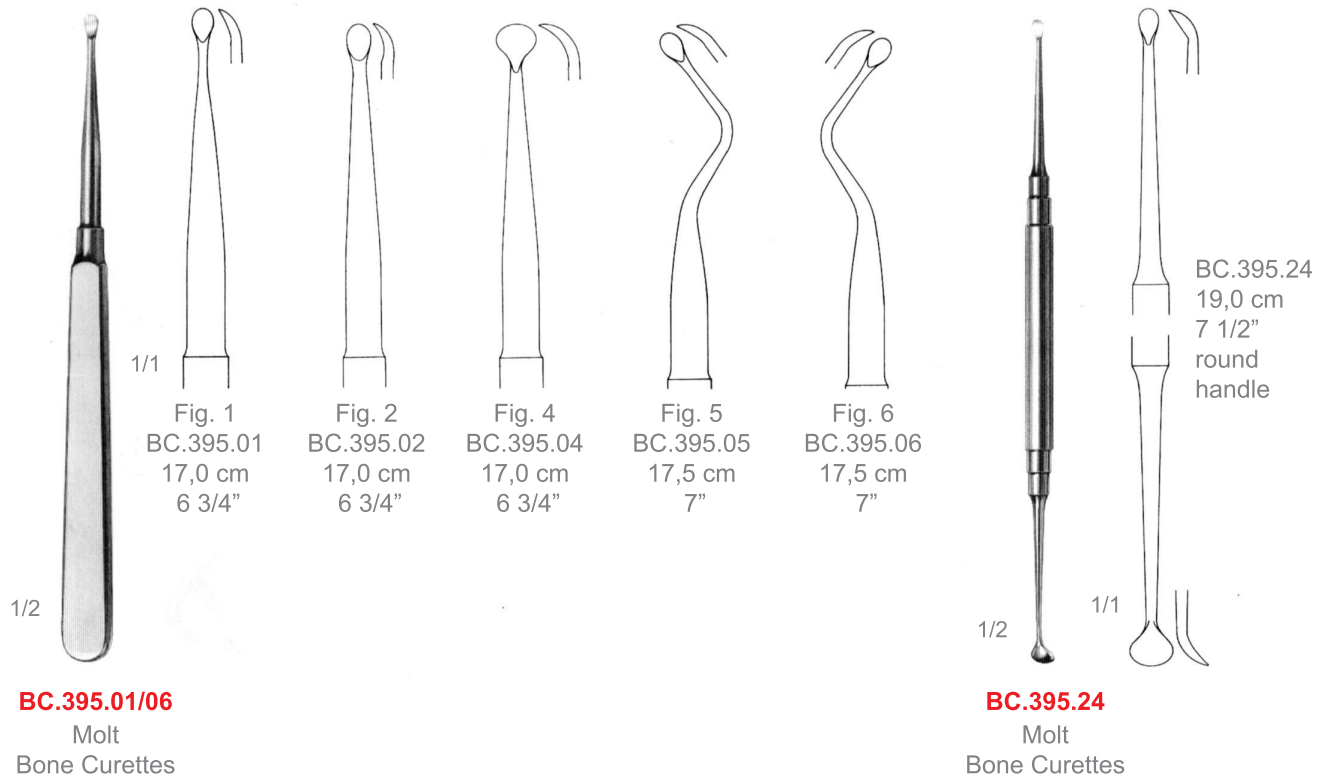
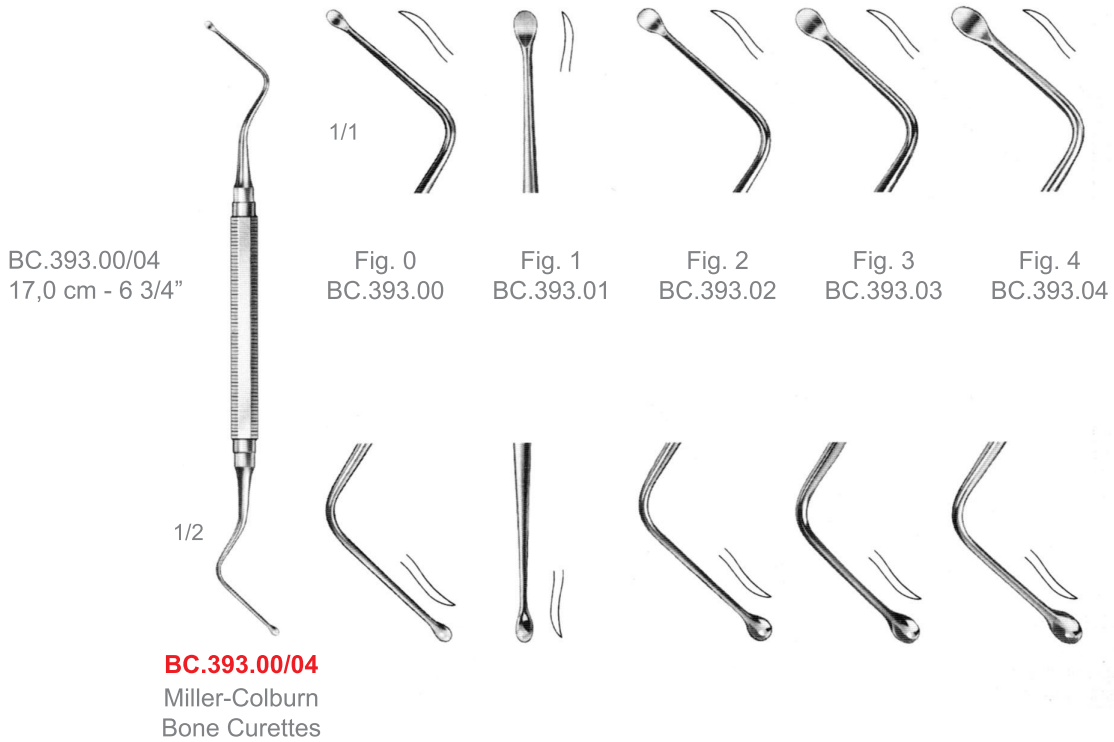

Periosteal Raspatories

RASPATORIEN - LEGRAS-PERIOSTÓTOMOS

Kolpen

BONE SURGERY
KNOCHENCHIRURGIE
CIRUGÍA OSEA

BC



1/2

BC.400.01/04
Martin-Langenbeck
Periosteal Raspatories

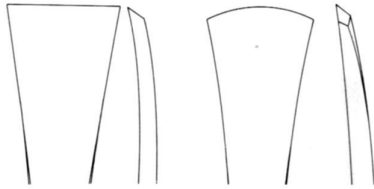

BC.400.01 19,0 cm - 7 1/2"
16 mm
BC.400.02 19,0 cm - 7 1/2"
16 mm

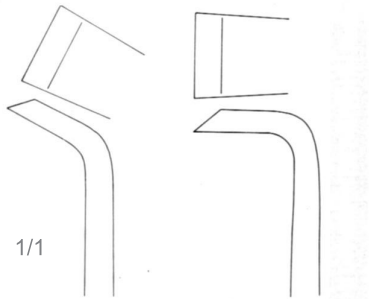

1/1
BC.400.03 19,0 cm - 7 1/2"
12 mm
BC.400.04 18,0 cm - 7"
12 mm



1/2

BC.400.10/12
Martin-Hoen
Periosteal Raspatories

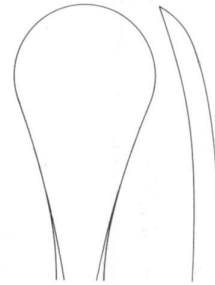

BC.400.10 16,0 cm - 6 1/4"
7 mm
BC.400.11 18,5 cm - 7 1/4"
15 mm
BC.400.12 19,0 cm - 7 1/2"
20 mm



1/2

BC.400.20/26
Martin-Cushing
Periosteal Raspatories

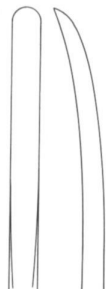

BC.400.20 17,0 cm - 6 3/4"
4 mm
BC.400.21 17,0 cm - 6 3/4"
6 mm
BC.400.25 19,5 cm - 7 3/4"
5 mm
BC.400.26 19,5 cm - 7 3/4"
7 mm



1/2

BC.400.30
Martin-Cushing
Periosteal Raspatories



1/1
BC.400.30 17,0 cm - 6 3/4"
8 mm

BC

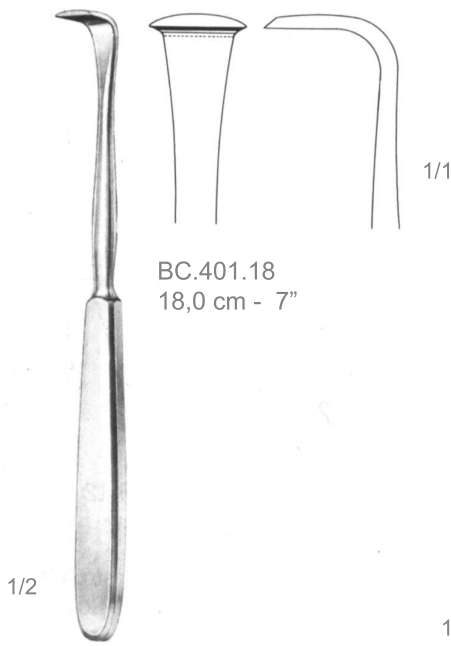

BC.401.18
18,0 cm - 7"

BC.401.18
Lagenbeck
Periosteal Raspatories

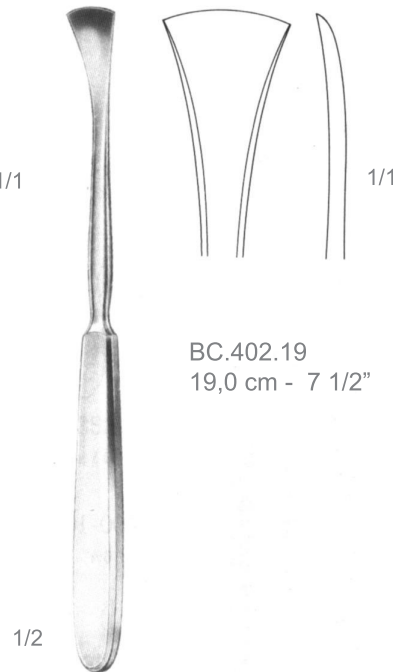

BC.402.19
19,0 cm - 7 1/2"

BC.402.19
Lagenbeck
Periosteal Raspatories

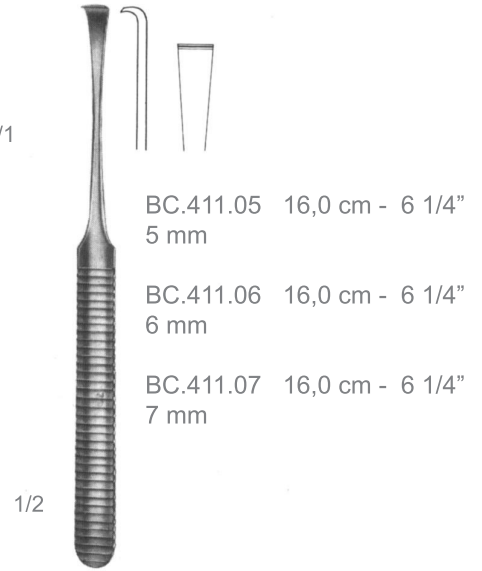

BC.411.05 16,0 cm - 6 1/4"
5 mm

BC.411.06 16,0 cm - 6 1/4"
6 mm

BC.411.07 16,0 cm - 6 1/4"
7 mm

BC.411.05/07
Periosteal Raspatories

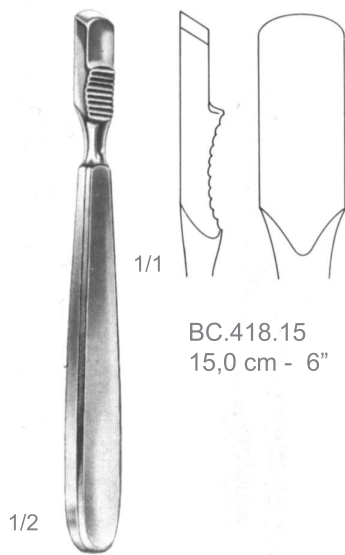

BC.418.15
15,0 cm - 6"

BC.418.15
Farabeuf
Periosteal Raspatories

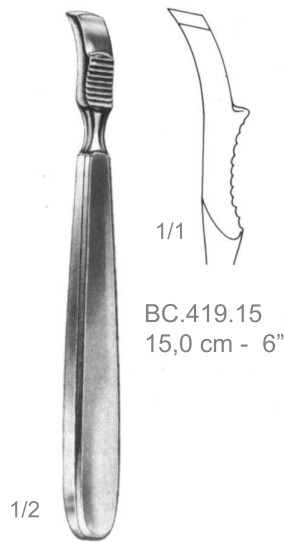

BC.419.15
15,0 cm - 6"

BC.419.15
Farabeuf
Periosteal Raspatories

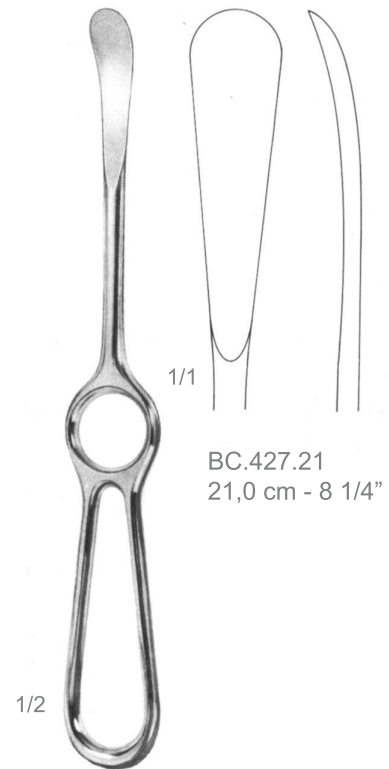

BC.427.21
21,0 cm - 8 1/4"

BC.427.21
Sedillot
Periosteal Raspatories

Periosteal Raspatories

RASPATORIEN - LEGRAS-PERIOSTÓTOMOS

Kolpen

BONE SURGERY
KNOCHENCHIRURGIE
CIRUGÍA OSEA

BC

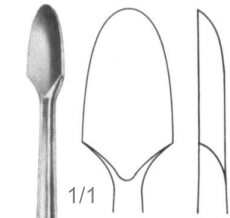

1/1

BC.430.20
20,0 cm - 8"
Handle from
artificial wood

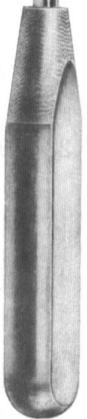

1/2

BC.430.20

Periosteal Raspatories



1/1

BC.431.20
20,0 cm - 8"
Handle from
artificial wood

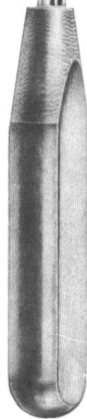

1/2

BC.431.20

Periosteal Raspatories



1/1

BC.437.20
20,0 cm - 8"
Handle from
artificial wood

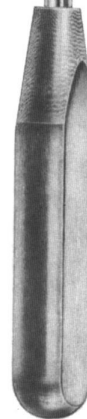

1/2

BC.437.20

Periosteal Raspatories

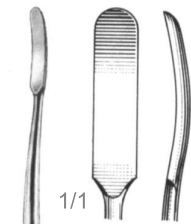

1/1

BC.432.18
18,0 cm - 7"
Handle from
artificial wood



1/2

BC.432.18

Periosteal Raspatories

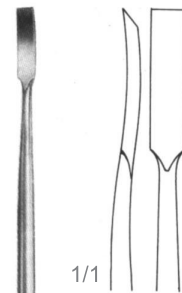

1/1

BC.433.18
18,0 cm - 7"
Handle from
artificial wood



1/2

BC.433.18

Periosteal Raspatories

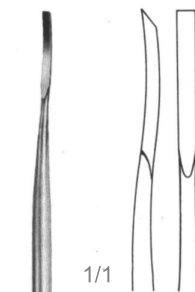

1/1

BC.435.18
18,0 cm - 7"
Handle from
artificial wood



1/2

BC.435.18

Periosteal Raspatories

BC

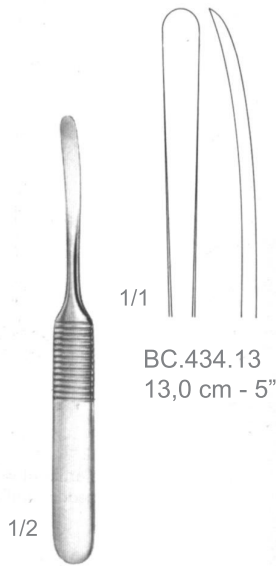

BC.434.13
Williger
Periosteal Raspatories

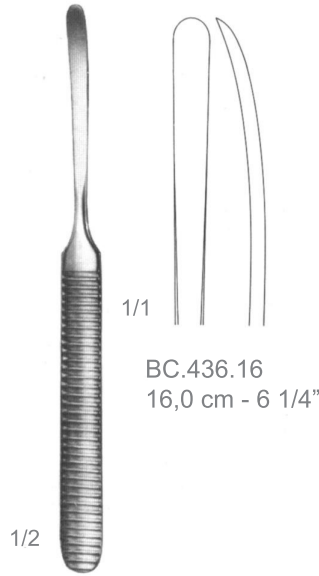

BC.436.16
Williger
Periosteal Raspatories

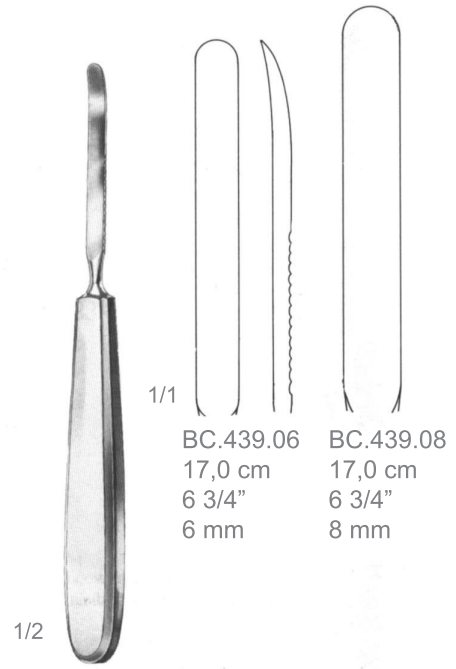

BC.439.06/08
Periosteal Raspatories

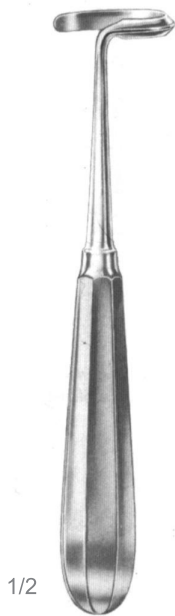

BC.441.17
BC.447.17
Doyen
Periosteal Raspatories

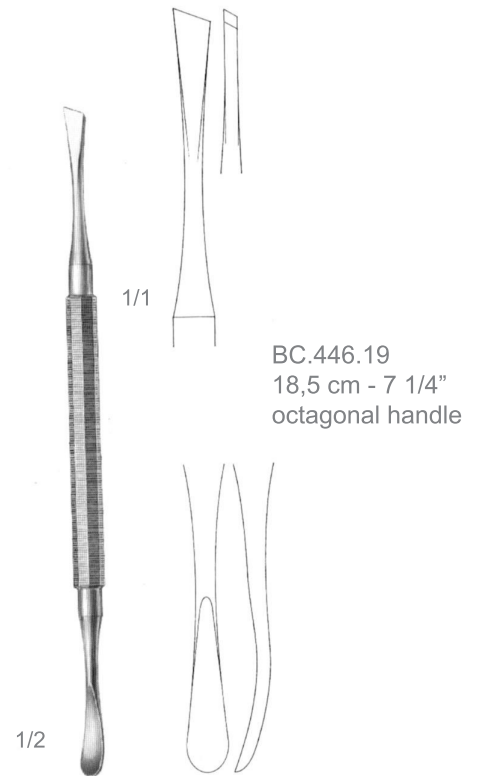
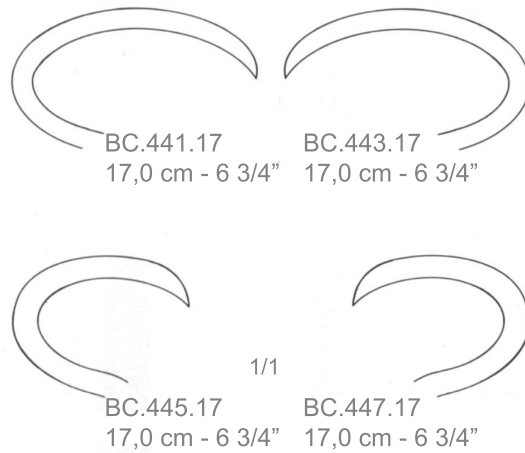

BC.446.19
West
Periosteal Raspatories

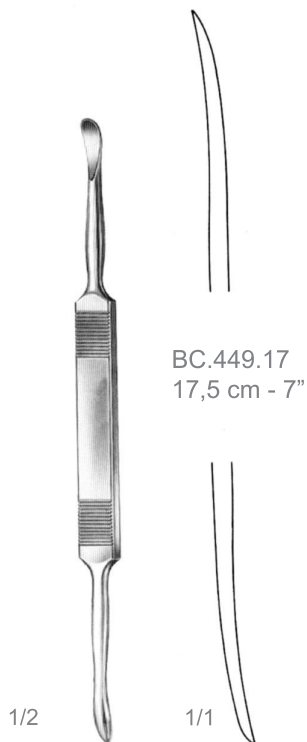

BC.449.17
17,5 cm - 7"

BC.449.17

Ohl
Periosteal Raspatories



BC.461.10 21,0 cm - 8 1/4" 10 mm
BC.461.15 21,0 cm - 8 1/4" 15 mm
BC.461.20 21,0 cm - 8 1/4" 20 mm
BC.461.25 21,0 cm - 8 1/4" 25 mm

BC.461.10/25

Lambotte
Periosteal Raspatories

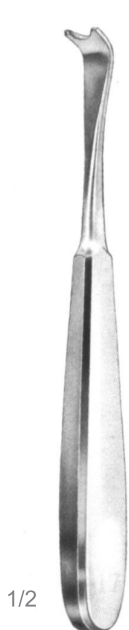

1/2

BC.450.01/05

Semb
Periosteal Raspatories



1/2

BC.450.01 17,5 cm - 7"
BC.450.02 21,0 cm - 8 1/4"



BC.450.03 17,5 cm - 7"
BC.450.04 21,0 cm - 8 1/4"



BC.450.05 20,5 cm - 8"

BC

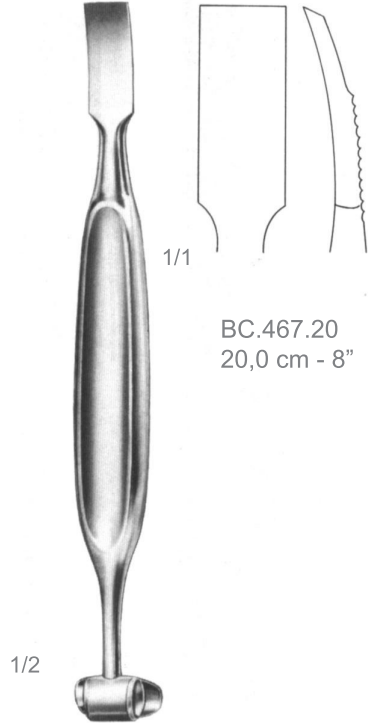

BC.467.20
20,0 cm - 8"

BC.467.20
Alexander
Periosteal Raspatories

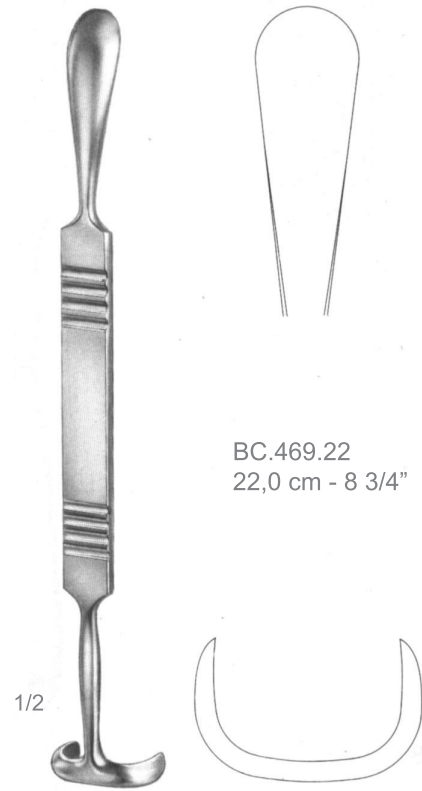

BC.469.22
22,0 cm - 8 3/4"

BC.469.22
Matson
Periosteal Raspatories

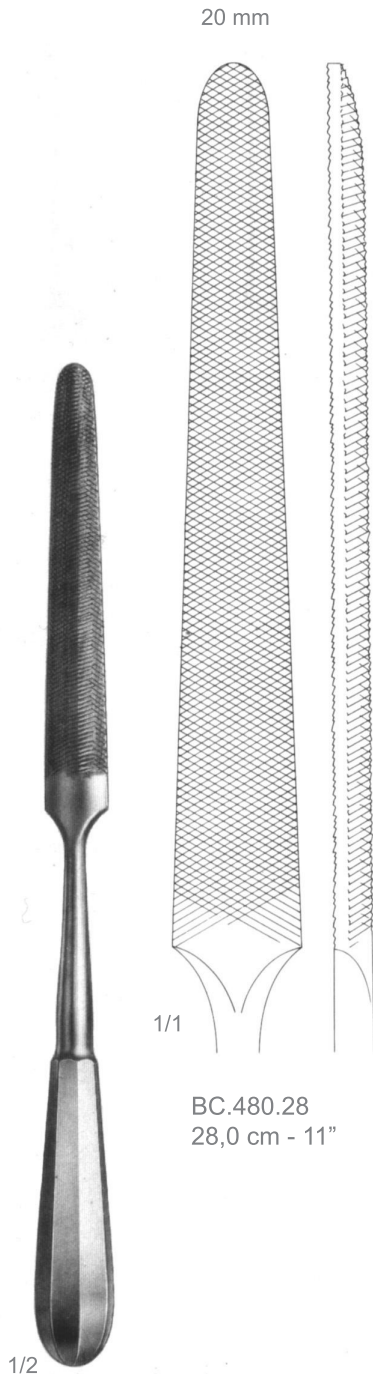

BC.480.28
28,0 cm - 11"

BC.480.28
Bone Files

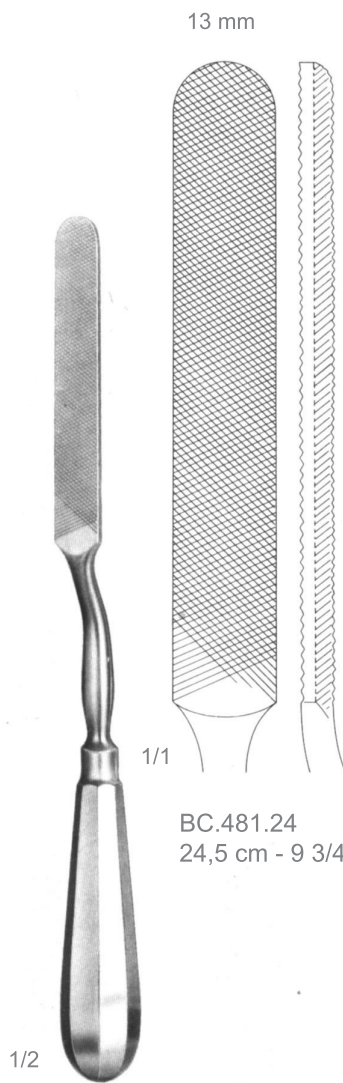

BC.481.24
24,5 cm - 9 3/4"

BC.481.24
Bone Files



BC.482.22
22,0 cm - 8 3/4"

BC.482.22
Bone Files

BC

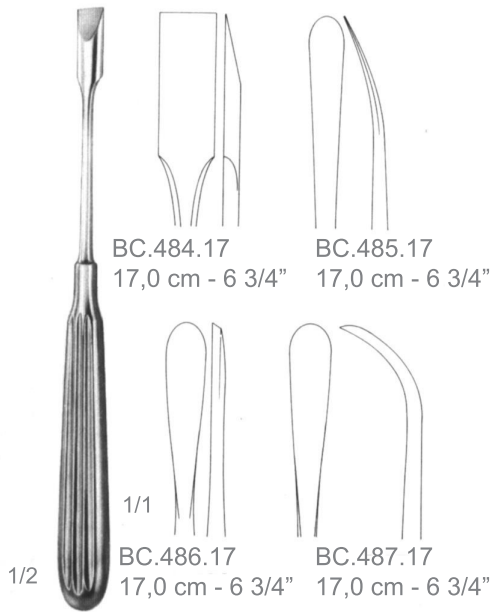

BC.484.17
17,0 cm - 6 3/4"

BC.485.17
17,0 cm - 6 3/4"

1/1
BC.486.17
17,0 cm - 6 3/4"

BC.487.17
17,0 cm - 6 3/4"

BC.484.17
BC.485.17
BC.486.17
BC.487.17
Elevators

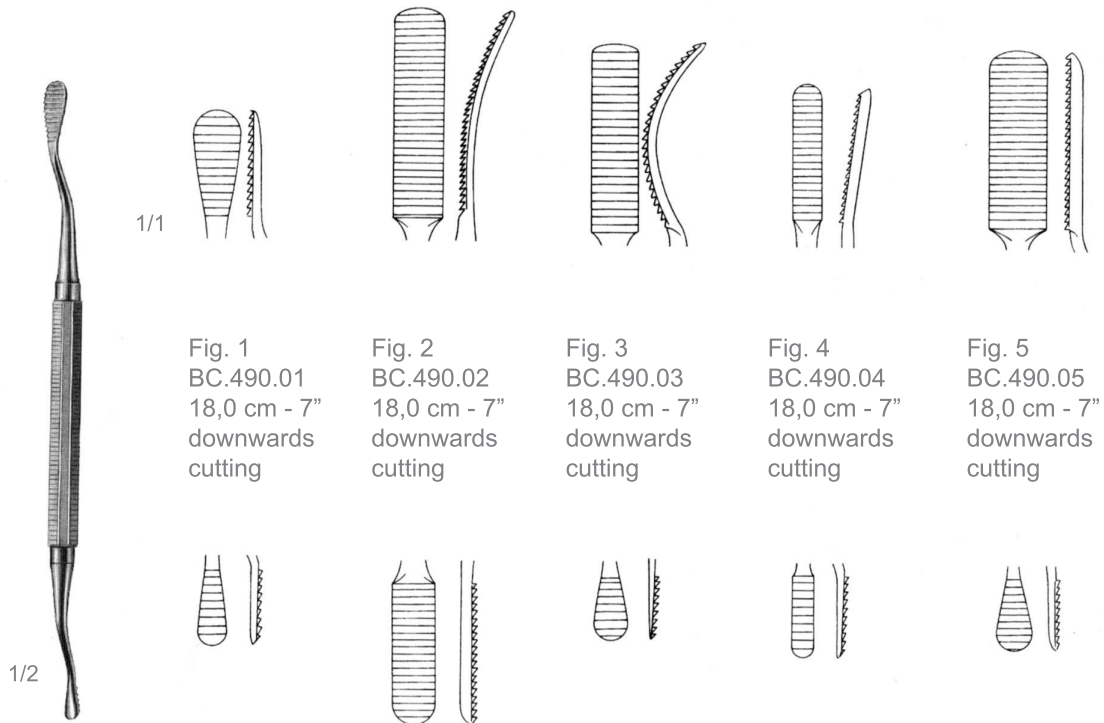

1/1

Fig. 1
BC.490.01
18,0 cm - 7"
downwards
cutting

Fig. 2
BC.490.02
18,0 cm - 7"
downwards
cutting

Fig. 3
BC.490.03
18,0 cm - 7"
downwards
cutting

Fig. 4
BC.490.04
18,0 cm - 7"
downwards
cutting

Fig. 5
BC.490.05
18,0 cm - 7"
downwards
cutting

1/2

BC.490.01/05
Miller-Colburn
Elevators

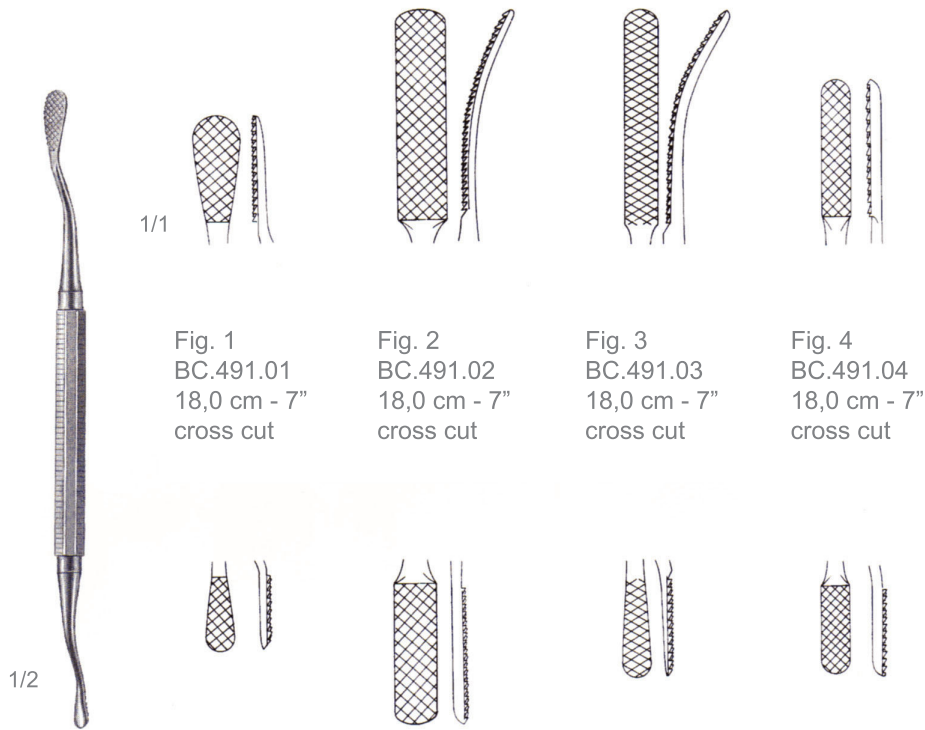

Fig. 1
BC.491.01
18,0 cm - 7"
cross cut

Fig. 2
BC.491.02
18,0 cm - 7"
cross cut

Fig. 3
BC.491.03
18,0 cm - 7"
cross cut

Fig. 4
BC.491.04
18,0 cm - 7"
cross cut

BC.491.01/04
Miller-Colburn
Elevators

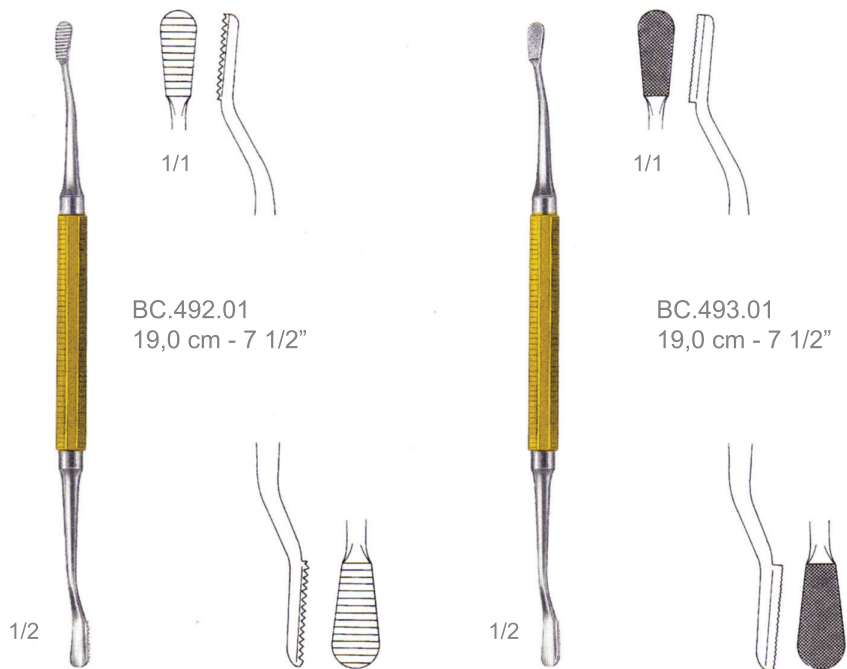

BC.492.01
19,0 cm - 7 1/2"

BC.493.01
19,0 cm - 7 1/2"

BC.492.01
Miller
Elevators

BC.493.01
Miller
Elevators

BC

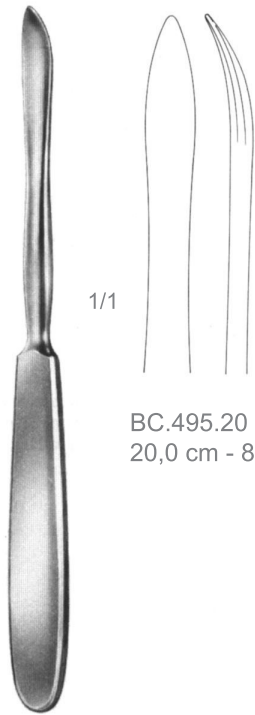

1/1

BC.495.20
20,0 cm - 8"



BC.497.20
20,0 cm - 8"

BC.495.20
BC.497.20
Langenbeck
Elevators



1/2

BC.499.01 17,0 cm - 6 3/4" 5 mm
BC.499.02 17,0 cm - 6 3/4" 7 mm
BC.499.03 20,0 cm - 8" 8 mm
BC.499.04 20,0 cm - 8" 10 mm

BC.499.01/04
Martin-Langenbeck
Elevators

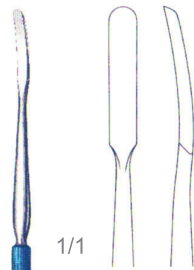

1/1

BC.506.17
17,0 cm - 6 3/4"
handle from
Titanium

1/2

BC.506.17
Vickers
Elevators

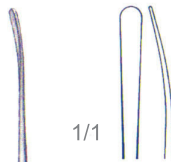

1/1

BC.508.17
17,0 cm - 6 3/4"
handle from
Titanium
Dissector

1/2

BC.508.17
Vickers
Elevators



1/1

BC.510.17
17,0 cm - 6 3/4"

1/2

BC.510.17
Williger
Elevators



1/1

BC.513.16
16,0 cm - 6 1/4"

1/2

BC.513.16
Williger
Elevators

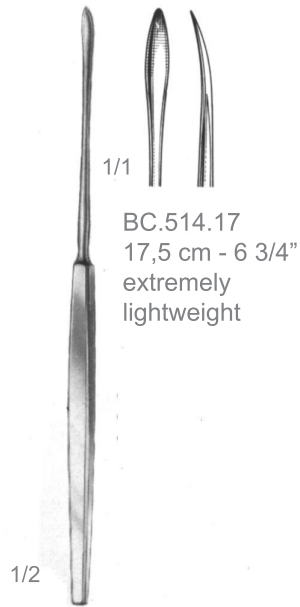

BC.514.17
Elevators

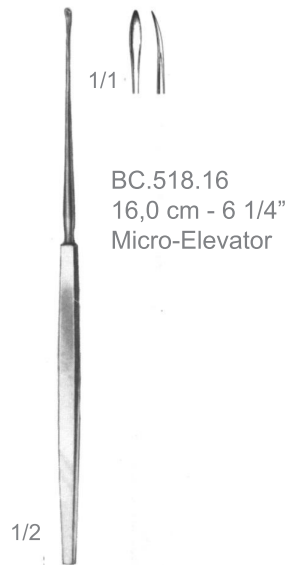

BC.518.16
Elevators

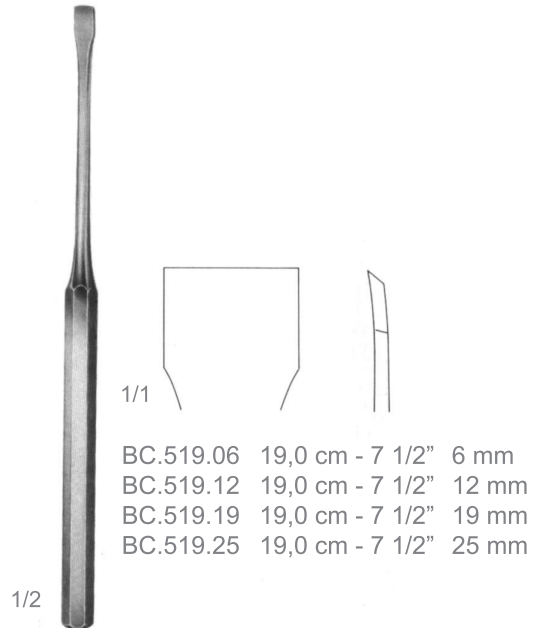

BC.519.06/25
Key
Elevators

BC.519.06	19,0 cm - 7 1/2"	6 mm
BC.519.12	19,0 cm - 7 1/2"	12 mm
BC.519.19	19,0 cm - 7 1/2"	19 mm
BC.519.25	19,0 cm - 7 1/2"	25 mm



BC.523.16
Elevators



BC.525.21
Alderdyce
Elevators



BC.527.19
McDonald
Elevators

BC

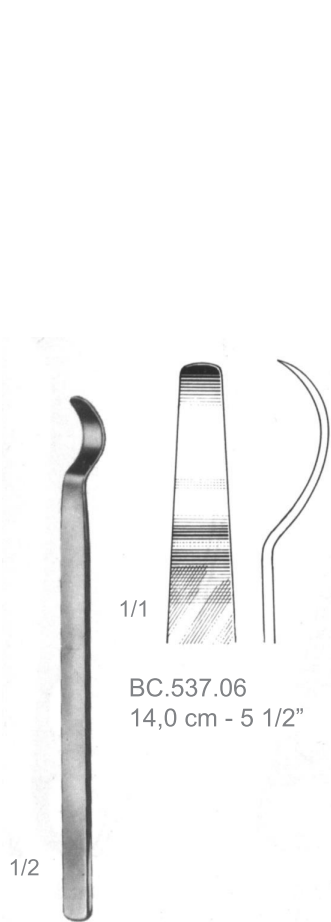

BC.537.06
14,0 cm - 5 1/2"

BC.537.06
Bone Levers



BC.539.06/08
16,0 cm - 6 1/4"

BC.539.06/08
Mini-Hohmann
Bone Levers



BC.539.15
15 mm

BC.539.15
Bone Levers

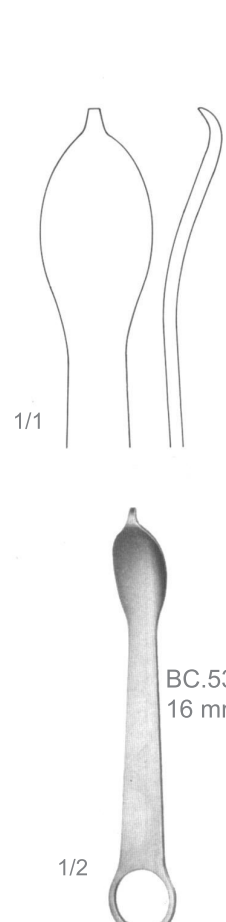

BC.539.16
16 mm

BC.539.16
Bone Levers

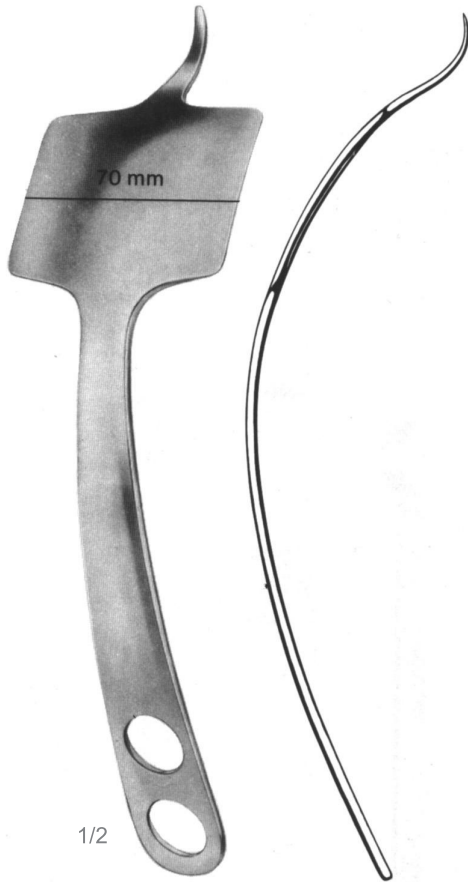

BC.541.08/70

Hohmann
Bone Levers

- BC.541.08 8 mm
- BC.541.18 18 mm
- BC.541.43 43 mm
- BC.541.70 70 mm



BC.543.43

Hohmann
Bone Levers

- BC.543.43 43 mm

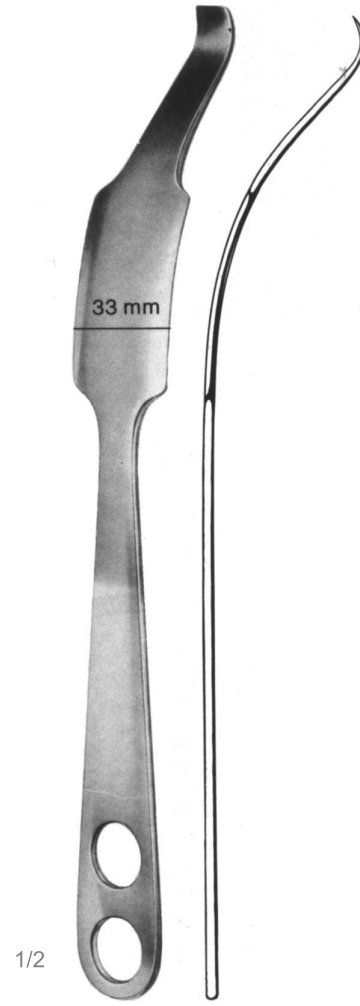

BC.545.22/35

Hohmann
Bone Levers

- BC.545.22 22 mm
- BC.545.35 35 mm

BC



BC.547.24
Hohmann
Bone Levers
BC.547.24 24 mm



BC.549.22
Lange-Hohmann
Bone Levers
BC.549.22 22 mm

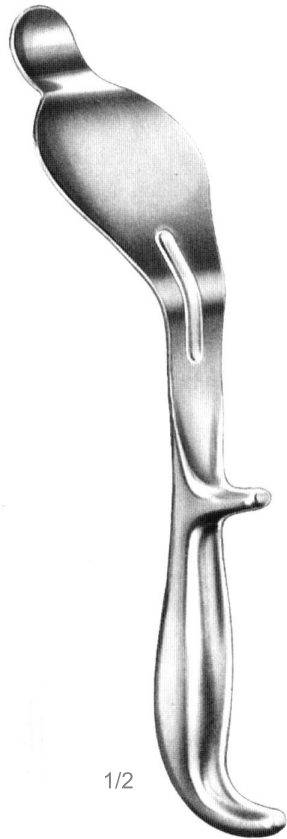

1/2

BC.559.24
BC.561.24
Bennett
Bone Levers

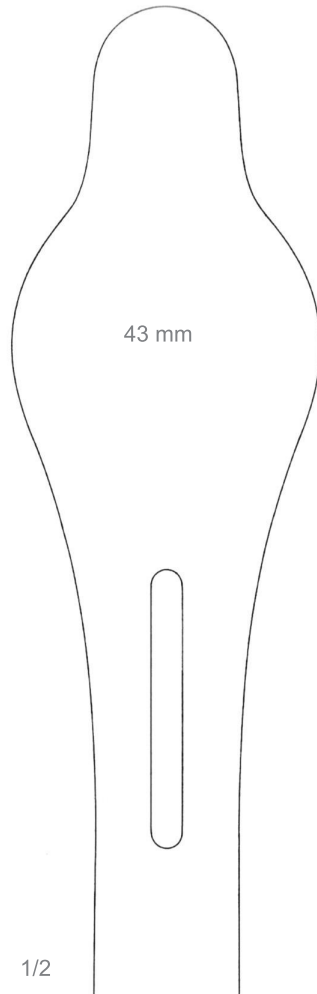

1/2

BC.559.24
24,0 cm - 9 1/2"

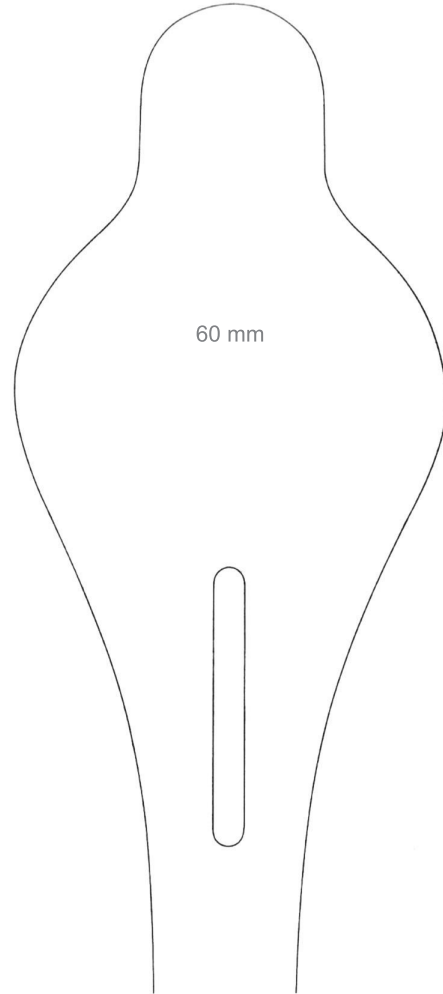

BC.561.24
23,5 cm - 9 1/4"

BC



BC.561.24
24,0 cm - 9 1/2"

1/3

BC.561.24
Bennett
Bone Levers



BC.563.26
26,0 cm - 10 1/4"

1/3

BC.563.26
Blount
Bone Levers



BC.565.23
26,0 cm - 10 1/4"

1/3

BC.565.26
Blount
Bone Levers

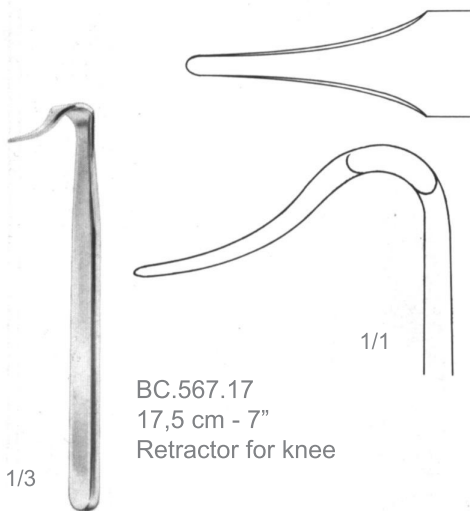

BC.567.17
17,5 cm - 7"
Retractor for knee

1/3

BC.567.17
Blount
Bone Levers

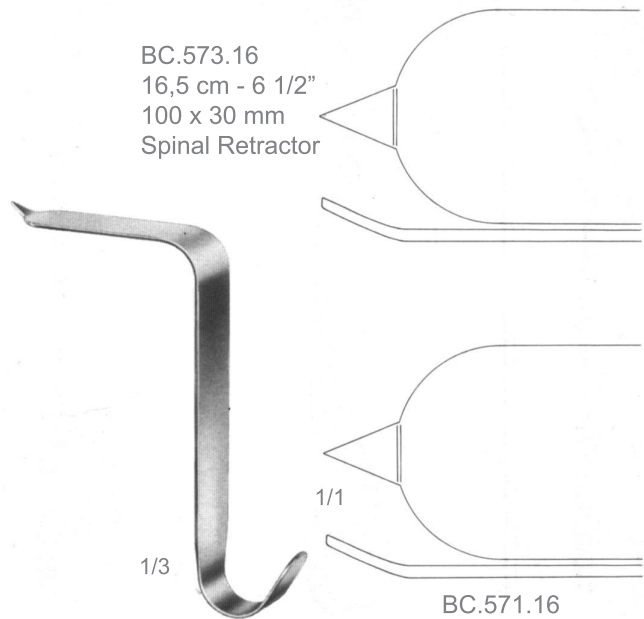

BC.573.16
16,5 cm - 6 1/2"
100 x 30 mm
Spinal Retractor

1/1

1/3

BC.571.16
BC.573.16
Taylor
Bone Levers

BC.571.16
16,5 cm - 6 1/2"
75 x 30 mm
Spinal Retractor

Meniscotomy Knives

MENISKOTOME - BISTURÍES PARA MENISCOS

Kolpen

BONE SURGERY
KNOCHENCHIRURGIE
CIRUGÍA OSEA

BC

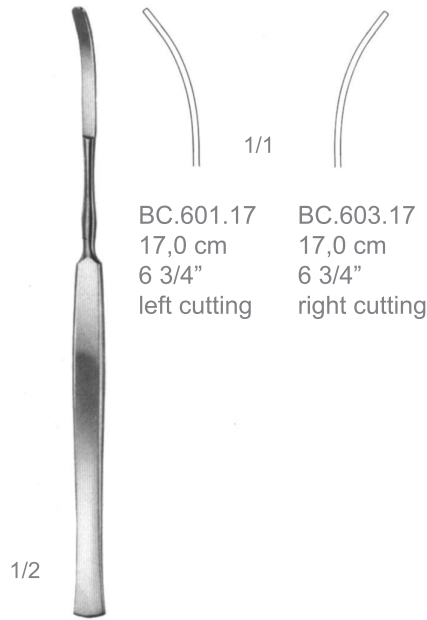

BC.601.17
BC.603.17

Mod. Schweden
Meniscotomy Knives

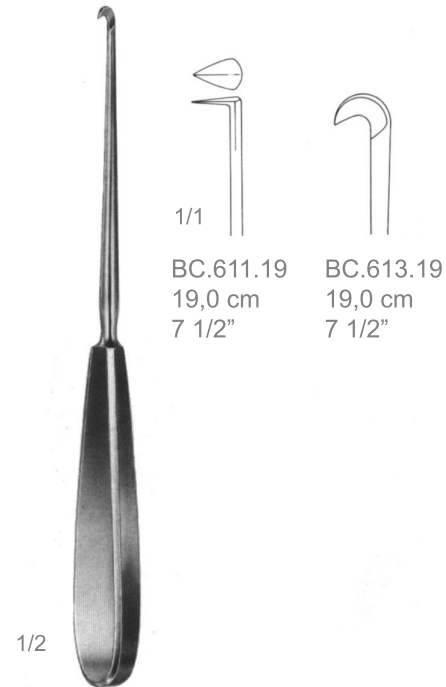

BC.611.19
BC.613.19

Bircher
Meniscotomy Knives

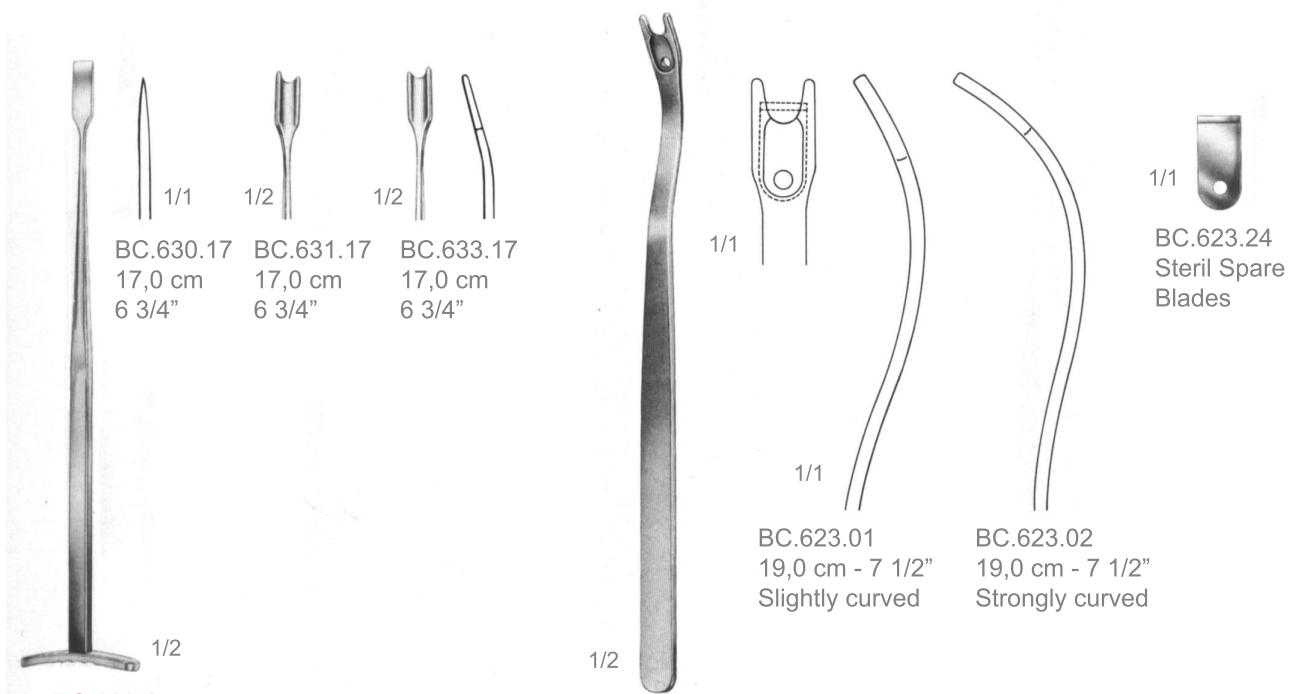

BC.630.17
BC.633.17

Smillie
Meniscotomy Knives

BC.623.01/24

Stryker-Scholl
Meniscotomy Knives

Kolpen

Meniscotomy Knives

BONE SURGERY
KNOCHENCHIRURGIE
CIRUGÍA OSEA

MENISKOTOME - BISTURÍES PARA MENISCOS

BC

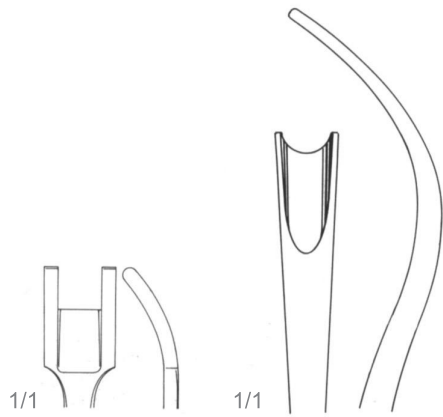

BC.637.25
Lowe-Breck
Meniscotomy
Knives

BC.637.25
25,0 cm - 10"

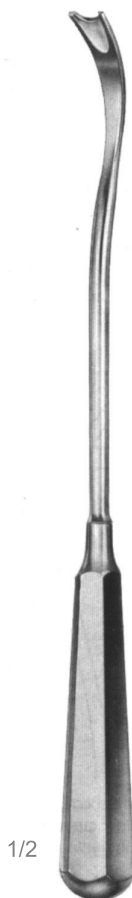
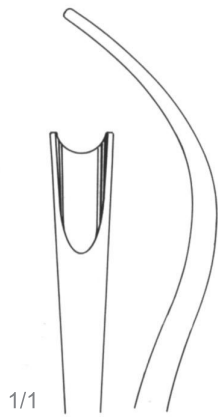

BC.639.25
Downing
Meniscotomy
Knives

BC.639.25
25,0 cm - 10"

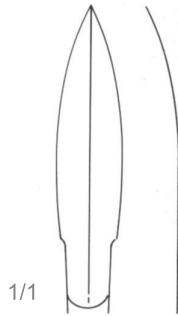

BC.641.18
Meniscotomy
Knives

BC.641.18
18,0 cm - 7"

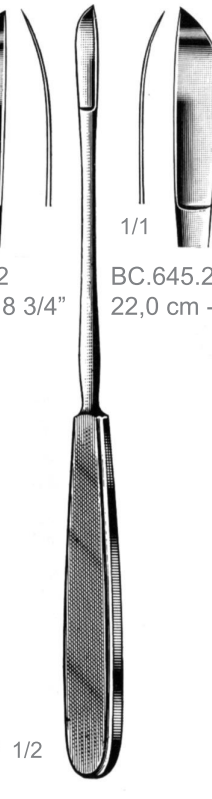
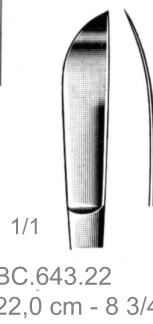

BC.643.22
BC.645.22
Neff
Meniscotomy
Knives

BC.643.22
22,0 cm - 8 3/4"

BC.645.22
22,0 cm - 8 3/4"



BC.650.22
Salenius
Meniscotomy
Knives

BC.650.22
22,0 cm - 8 3/4"

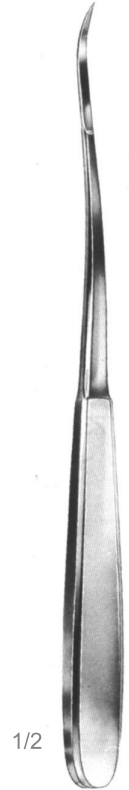

BC.651.22
Salenius
Meniscotomy
Knives

BC.651.22
22,0 cm - 8 3/4"

Tendon Stripper, Tendon Tunnel Instrument

SEHNENSTRIPPER, DURCHZUGINSTRUMENTE - SEPARADORES PARA TENDONES, INSTRUMENTOS PARA EL TÚNEL DEL TENDÓN

Kolpen

BONE SURGERY
KNOCHENCHIRURGIE
CIRUGÍA OSEA

BC

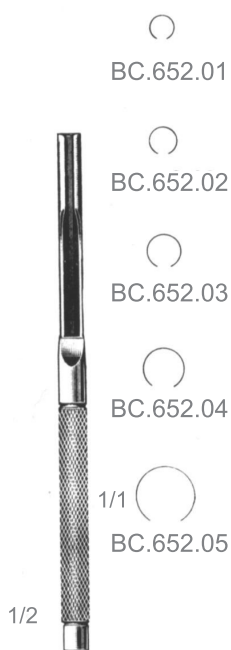

BC.652.01/05
Bunnell
Tendon Stripper

BC.652.01/05
15,0 cm - 6"

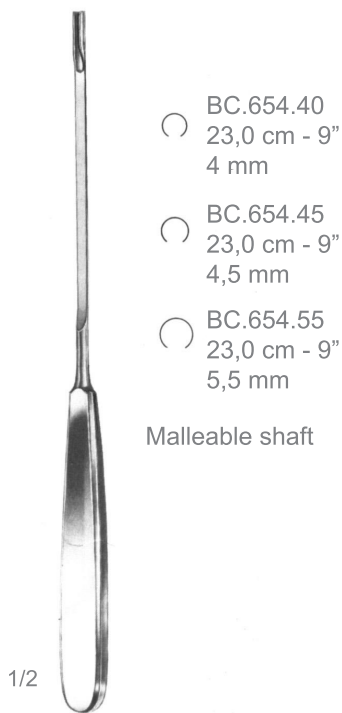

BC.654.40/55
Tendon Stripper

Malleable shaft

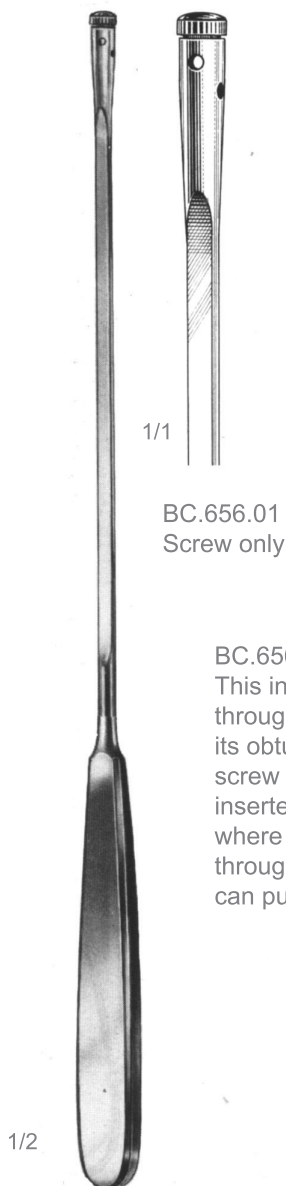

BC.656.00/01
Tendon Stripper

BC.656.00
33,5 cm

BC.656.01
Screw only

BC.656.00
This instrument is passed through the tendon tunnel with its obturating screw. Then the screw is removed and the tendon inserted into the front opening where it is fixed by some stitches through the wall holes so that it can be pulled through the tunnel.

BC



BC.660.31
Fischer
Tendon Stripper



BC.662.29
Tendon Stripper

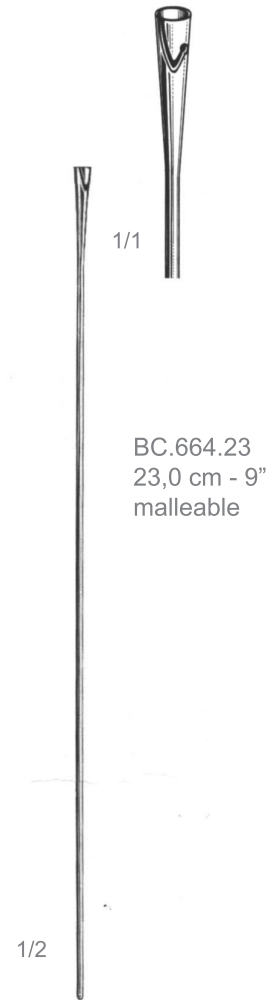

BC.664.23
Bunnel
Tendon Stripper

Tendon Seizing Instruments

SEHNENFABINSTRUMENTE - INSTRUMENTOS PARA COGER TENDONES

Kolpen

BONE SURGERY
KNOCHENCHIRURGIE
CIRUGÍA OSEA

BC

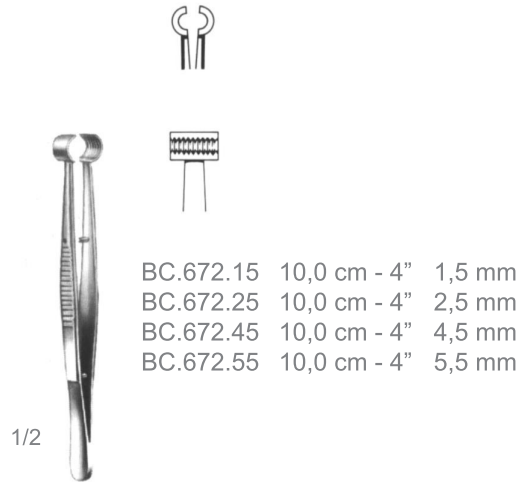

- | | | |
|-----------|--------------|--------|
| BC.672.15 | 10,0 cm - 4" | 1,5 mm |
| BC.672.25 | 10,0 cm - 4" | 2,5 mm |
| BC.672.45 | 10,0 cm - 4" | 4,5 mm |
| BC.672.55 | 10,0 cm - 4" | 5,5 mm |

BC.672.15/55
Tendon Seizing
Instruments

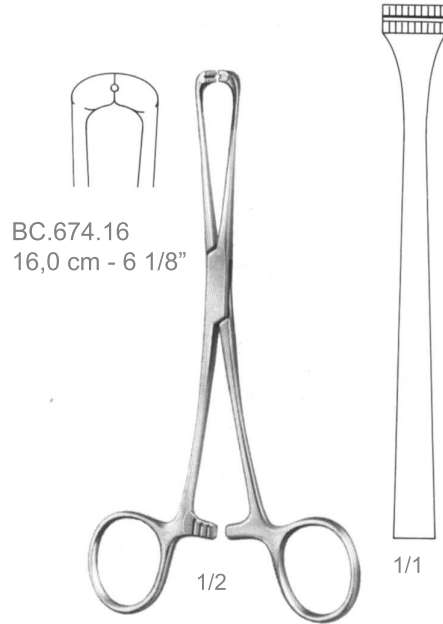

- BC.674.16
16,0 cm - 6 1/8"

BC.674.16
Steinmann
Tendon Seizing
Instruments



- | | |
|-----------|------------------|
| BC.676.15 | 15,0 cm - 6" |
| BC.676.19 | 19,0 cm - 7 1/2" |
| BC.676.24 | 24,0 cm - 9 1/2" |

BC.676.15/24
Brand
Tendon Seizing
Instruments

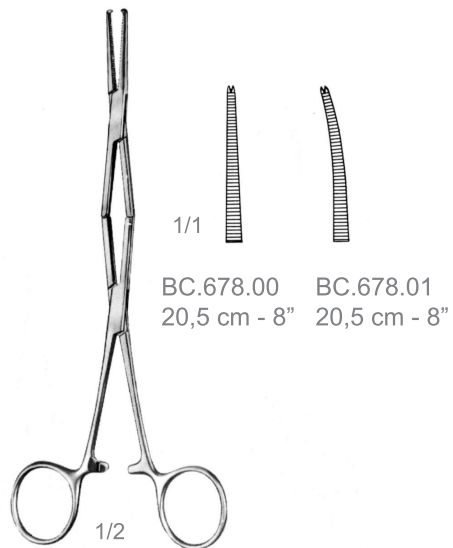

- | | |
|--------------|--------------|
| BC.678.00 | BC.678.01 |
| 20,5 cm - 8" | 20,5 cm - 8" |

BC.678.00/01
Tendon Seizing
Instruments

BC

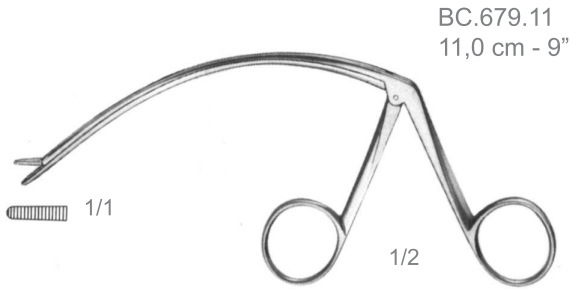

BC.679.11
11,0 cm - 9"

BC.679.11
Caroll
Tendon Seizing
Instruments



BC.680.13
13,0 cm - 5"

BC.680.13
Tendon Seizing
Instruments



BC.681.20
20,0 cm - 8"

BC.681.20
Kleinert-Kutz
Tendon Seizing
Instruments

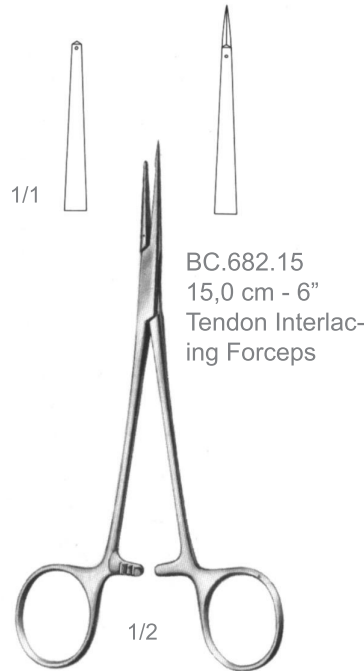

BC.682.15
15,0 cm - 6"
Tendon Interlac-
ing Forceps

BC.682.15
Tendon Seizing
Instruments

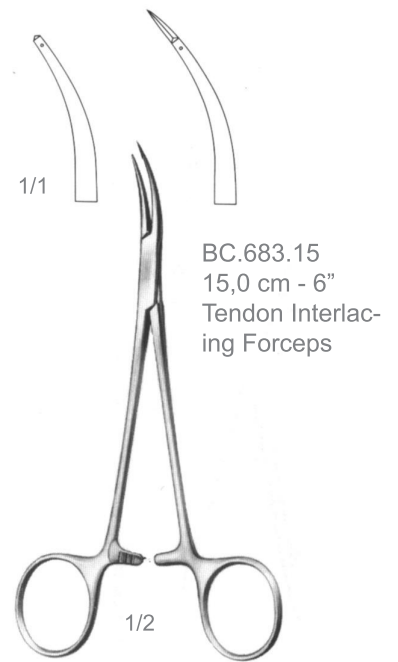

BC.683.15
15,0 cm - 6"
Tendon Interlac-
ing Forceps

BC.683.15
Tendon Seizing
Instruments

Bone Holding Forceps

KNOCHENHALTEZANGEN - PINZAS PARA HUESOS

Kolpen

BONE SURGERY
KNOCHENCHIRURGIE
CIRUGÍA OSEA

BC

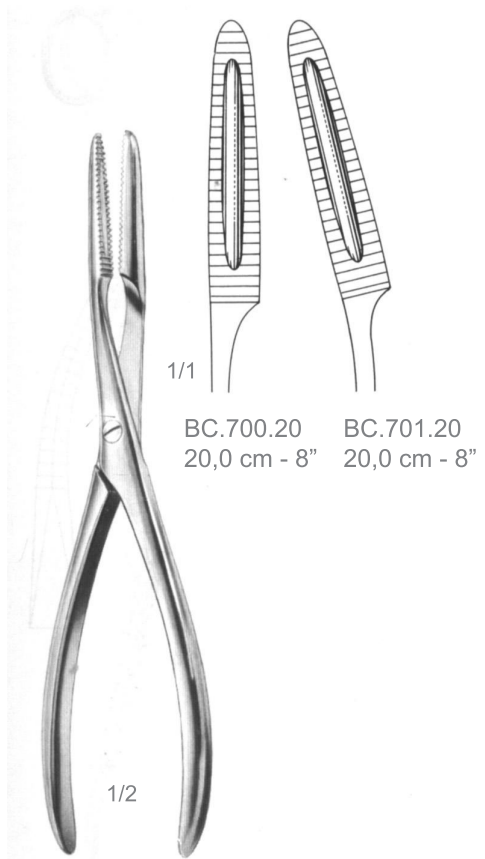

BC.700.20 20,0 cm - 8"
BC.701.20 20,0 cm - 8"

BC.700.20
BC.701.20
Bone Holding
Forceps

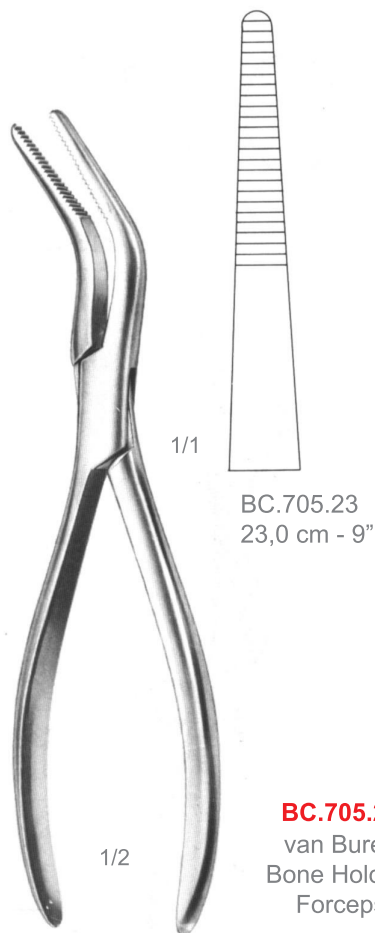

BC.705.23
23,0 cm - 9"

BC.705.23
van Buren
Bone Holding
Forceps

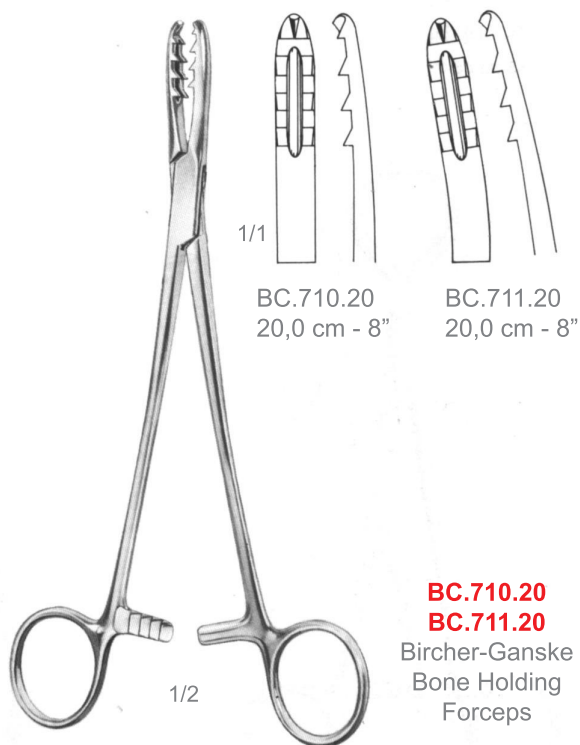

BC.710.20 20,0 cm - 8"
BC.711.20 20,0 cm - 8"

BC.710.20
BC.711.20
Bircher-Ganske
Bone Holding
Forceps

BC

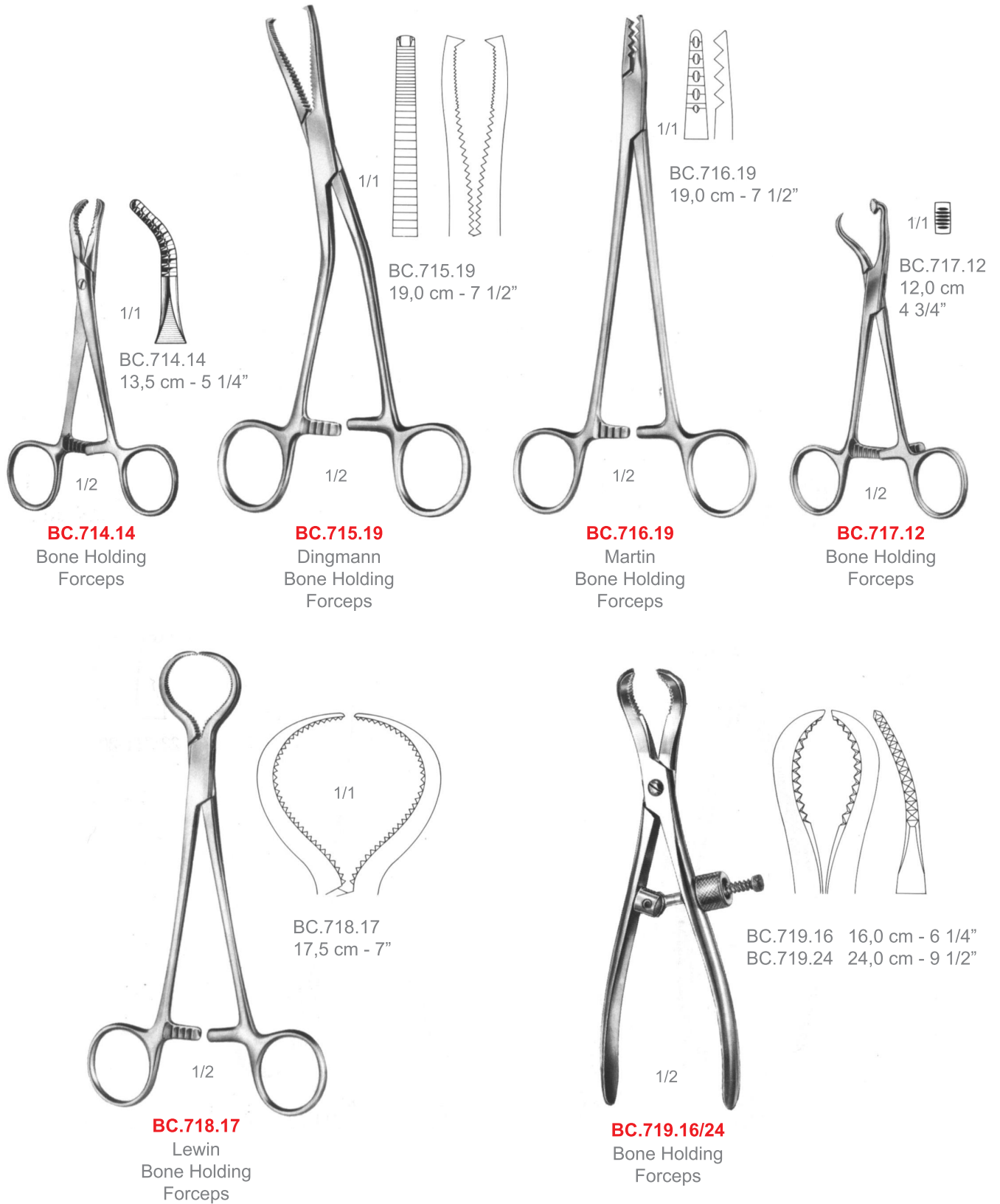

Bone Holding Forceps

KNOCHENHALTEZANGEN - PINZAS PARA HUESOS

Kolpen

BONE SURGERY
KNOCHENCHIRURGIE
CIRUGÍA OSEA

BC



BC.720.14
14,0 cm - 5 1/2"

BC.720.14
Bone Holding
Forceps

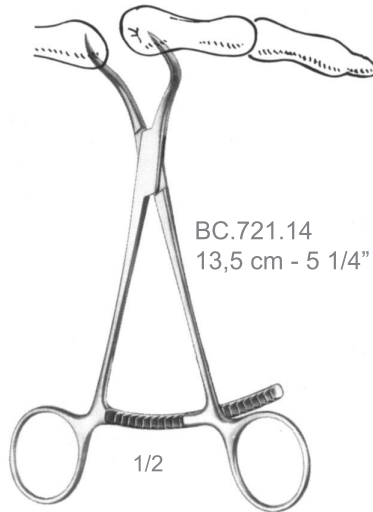

BC.721.14
13,5 cm - 5 1/4"

BC.721.14
Bone Holding
Forceps

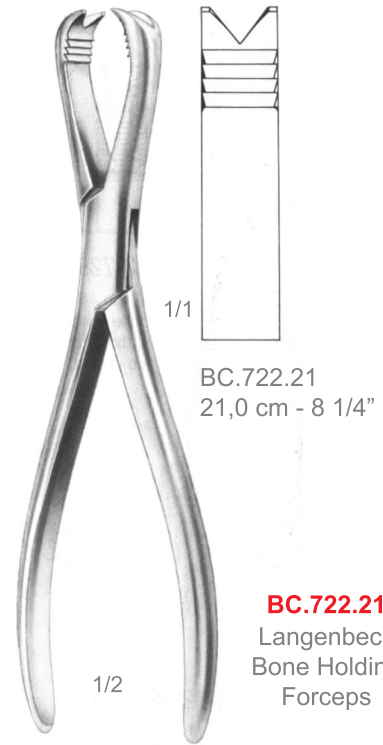

BC.722.21
21,0 cm - 8 1/4"

BC.722.21
Langenbeck
Bone Holding
Forceps



BC.724.21
21,0 cm - 8 1/4"

BC.724.21
Fergusson
Bone Holding
Forceps



BC.726.18
18,0 cm - 7"

BC.726.18
Frosch
Bone Holding
Forceps

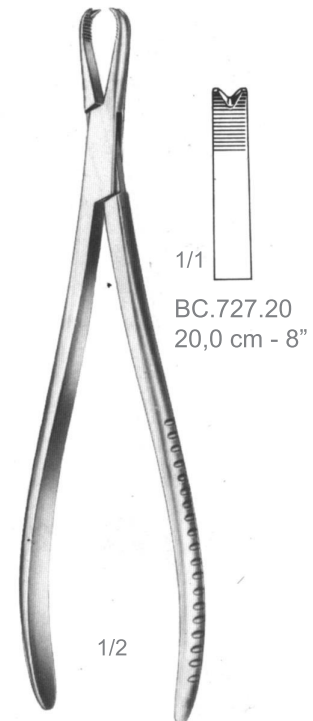

BC.727.20
20,0 cm - 8"

BC.727.20
Bone Holding
Forceps

BC

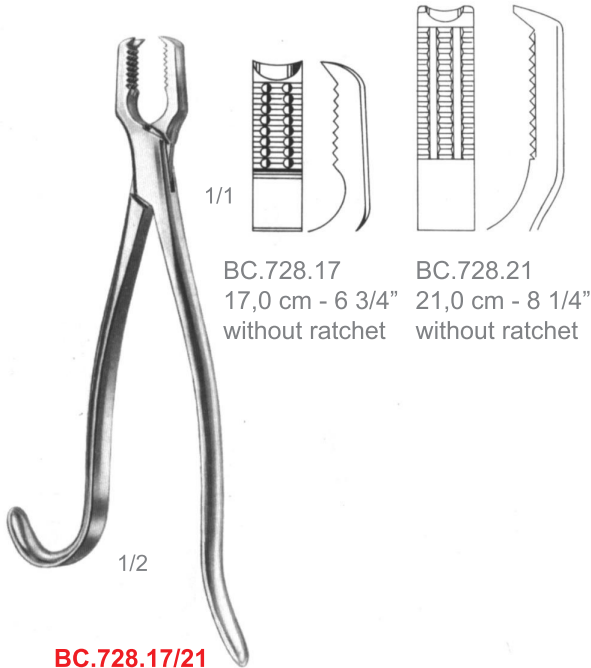

BC.728.17
17,0 cm - 6 3/4"
without ratchet

BC.728.21
21,0 cm - 8 1/4"
without ratchet

BC.728.17/21
Kern
Bone Holding
Forceps



BC.730.17
17,0 cm - 6 3/4"
with ratchet

BC.730.21
21,0 cm - 8 1/4"
with ratchet

BC.730.17/21
Kern
Bone Holding
Forceps

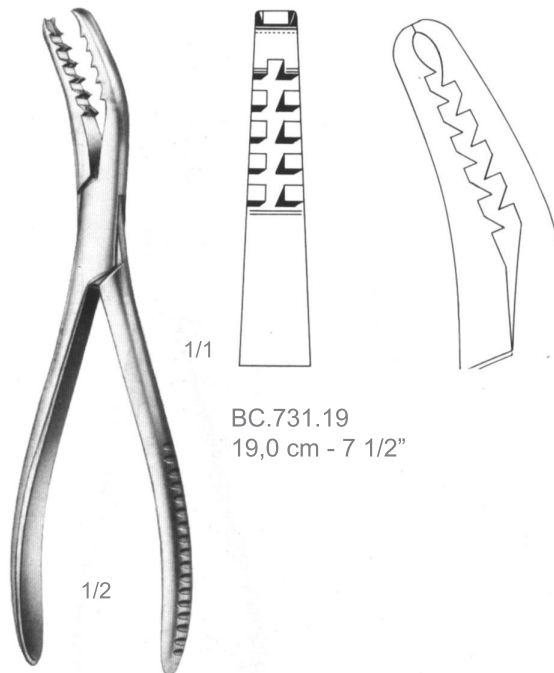

BC.731.19
19,0 cm - 7 1/2"

BC.731.19
Semb
Bone Holding
Forceps



BC.732.23
23,0 cm - 9"

BC.732.26
26,0 cm - 10 1/4"

adjustable

BC.732.23/26

Farabeuf
Bone Holding
Forceps

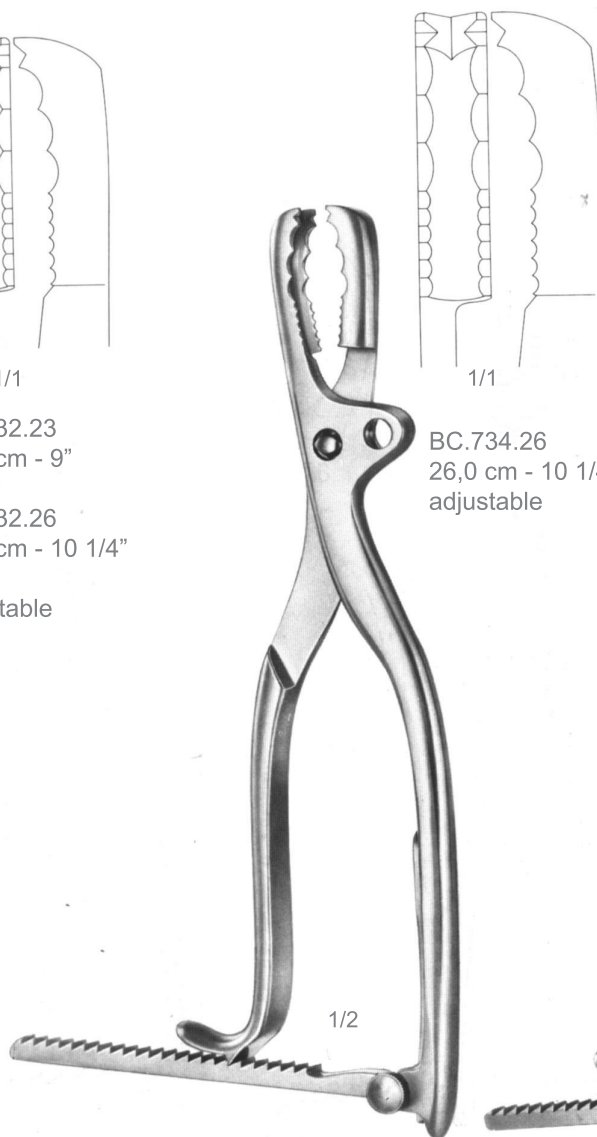

BC.734.26
26,0 cm - 10 1/4"
adjustable

1/2

BC.734.26

Farabeuf-Lambotte
Bone Holding
Forceps



BC.738.27
27,0 cm - 10 1/2"
adjustable

1/2

BC.738.27

Tuffier
Bone Holding
Forceps

BC

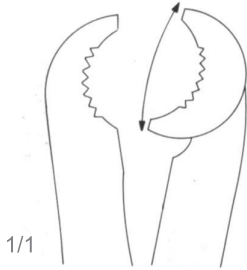

1/1

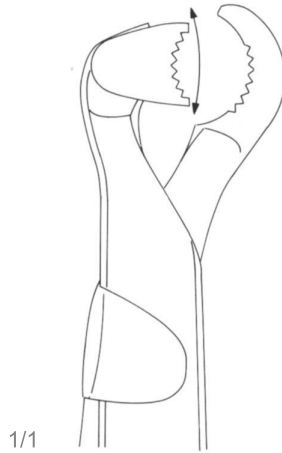

1/1

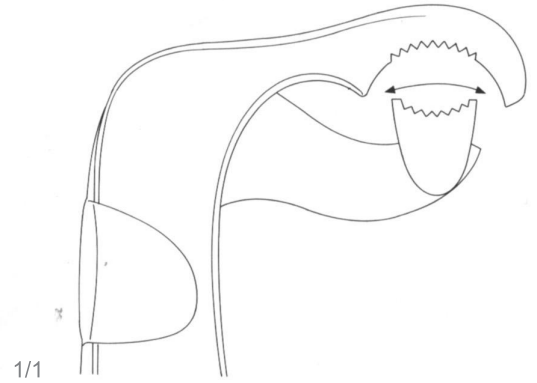

1/1



BC.740.22/30

Lambotte
Bone Holding
Forceps

BC.740.22 22,0 cm - 8 3/4"
BC.740.27 27,0 cm - 10 1/2"
BC.740.30 30,0 cm - 12"



BC.742.22/33

Lambotte
Bone Holding
Forceps

BC.742.22 22,0 cm - 8 3/4"
BC.742.26 26,0 cm - 10 1/4"
BC.742.33 33,0 cm - 13"



BC.745.19/26

Lambotte
Bone Holding
Forceps

BC.745.19 19,0 cm - 7 1/2"
BC.745.23 23,0 cm - 9"
BC.745.26 26,0 cm - 10 1/4"

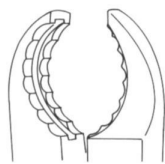
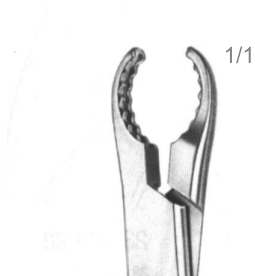
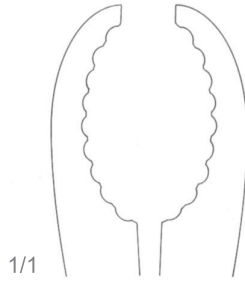
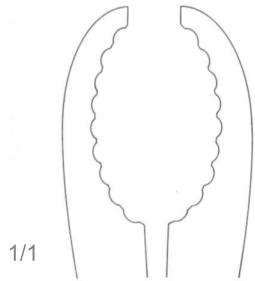

BC.746.23 23,0 cm - 9"
BC.746.25 25,0 cm - 10"
BC.746.28 28,0 cm - 11"

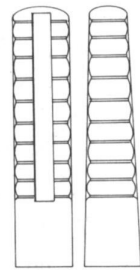
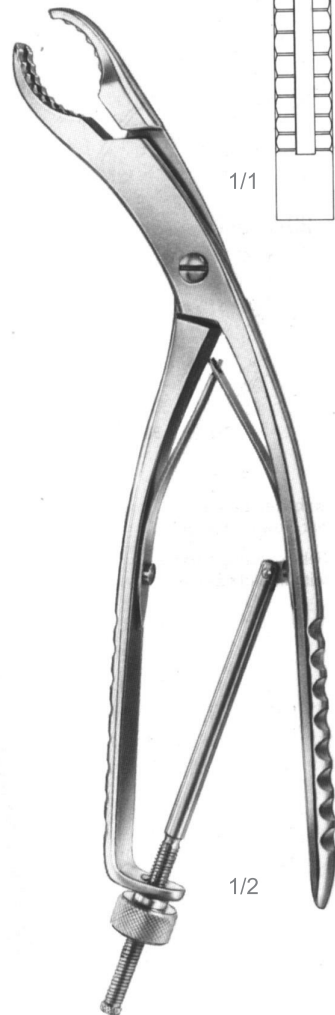

BC.746.23/28
Ulrich
Bone Holding
Forceps

BC.747.28
Ulrich
Bone Holding
Forceps

BC



BC.750.33/45
BC.752.33/45
Lane
Bone Holding
Forceps

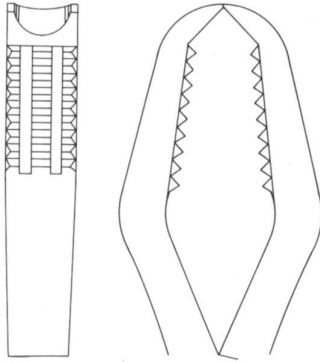

- | | | |
|-----------|-------------------|-----------------|
| BC.750.33 | 33,0 cm - 13" | without ratchet |
| BC.750.45 | 45,0 cm - 17" | without ratchet |
| BC.752.33 | 33,0 cm - 13" | with ratchet |
| BC.752.45 | 45,0 cm - 17 3/4" | with ratchet |

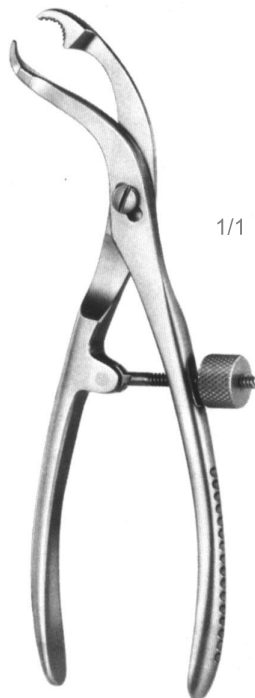

BC.749.15/28
Bone Holding
Forceps

1/1



2,5 mm



- | | | |
|-----------|-------------------|--------|
| BC.749.15 | 15,0 cm - 6" | 2,5 mm |
| BC.749.19 | 19,0 cm - 7 1/2" | 6,5 mm |
| BC.749.24 | 24,0 cm - 9 1/2" | 9,5 mm |
| BC.749.26 | 26,0 cm - 10 1/4" | 10 mm |
| BC.749.28 | 28,0 cm - 11" | 11 mm |

Self-centering forceps
with thread fixation

Bone Holding Forceps, Retractors

KNOCHENHALTEZANGEN, RETRAKTOREN -
PINZAS PARA HUESOS, RETRACTORES

Kolpen

BONE SURGERY
KNOCHENCHIRURGIE
CIRUGÍA OSEA

BC

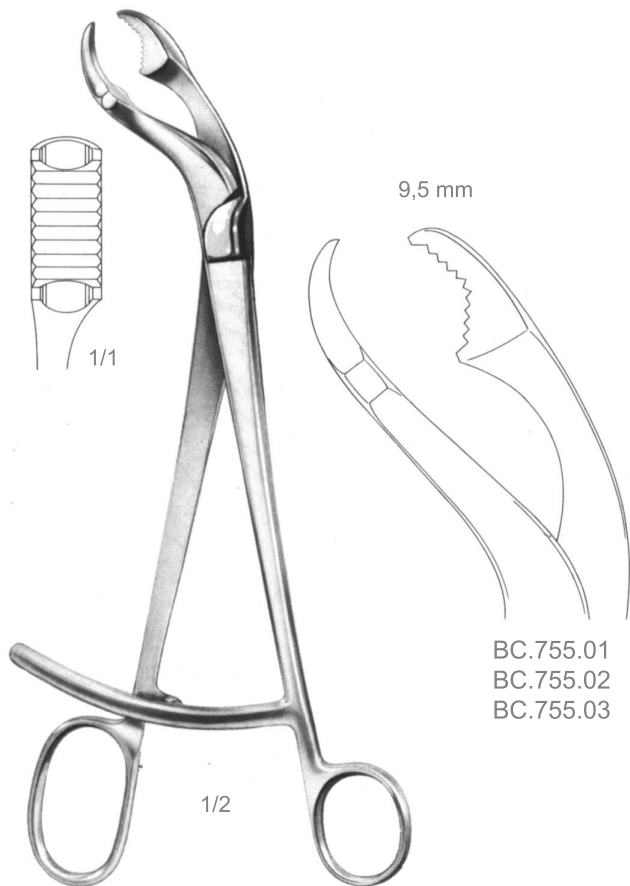

BC.755.01	25,0 cm - 10"	9,5 mm
BC.755.02	26,0 cm - 10 1/2"	10,5 mm
BC.755.03	27,0 cm - 11"	12 mm

BC.755.01/03

Verbrugge
Bone Holding Forceps,
Retractors

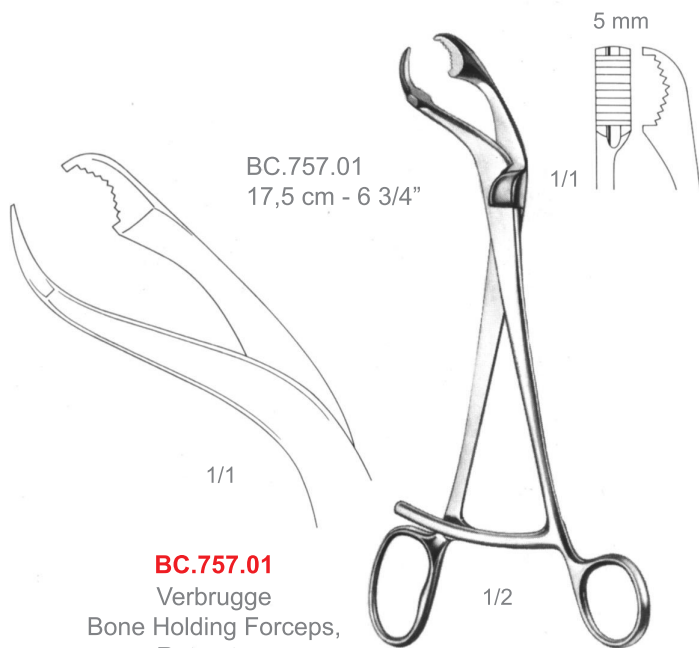

BC.757.01
17,5 cm - 6 3/4"

BC.757.01

Verbrugge
Bone Holding Forceps,
Retractors

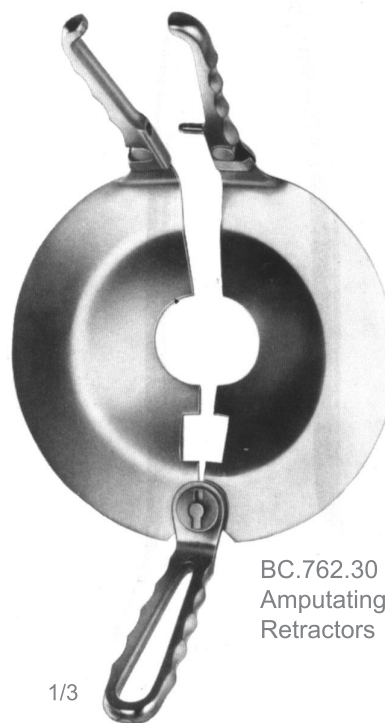

BC.762.30
Amputating
Retractors

BC.762.30

Percy
Bone Holding Forceps,
Retractors

BC



1/1
BC.777.01
17,0 cm
6 3/4"
2 mm

BC.777.01/02
Stellbrink
Bone Rongeur Forceps



1/1
BC.777.02
17,0 cm
6 3/4"
2 mm



1/1
BC.799.12
12,0 cm
5"

BC.799.12
Mini-Friedman
Bone Rongeur Forceps

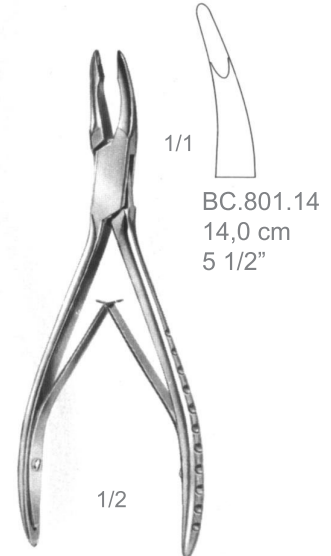

1/1
BC.801.14
14,0 cm
5 1/2"

BC.801.14
Friedman
Bone Rongeur Forceps



1/1
BC.805.14
14,0 cm
5 1/2"

BC.805.14
Cleveland
Bone Rongeur Forceps



1/1
BC.807.17
17,0 cm
6 3/4"

BC.807.17
Cleveland
Bone Rongeur Forceps



1/1
BC.811.13
13,5 cm
5 1/4"

BC.811.13
Universal
Bone Rongeur Forceps

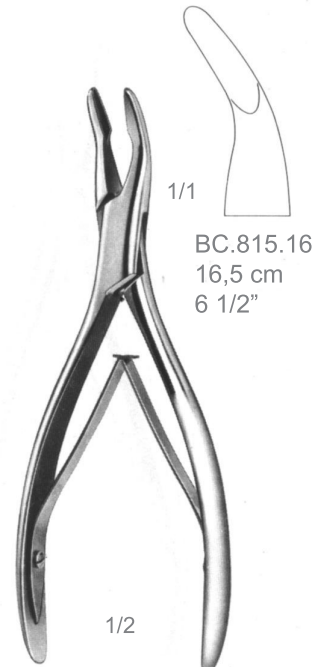

1/1
BC.815.16
16,5 cm
6 1/2"

BC.815.16
Mead
Bone Rongeur Forceps

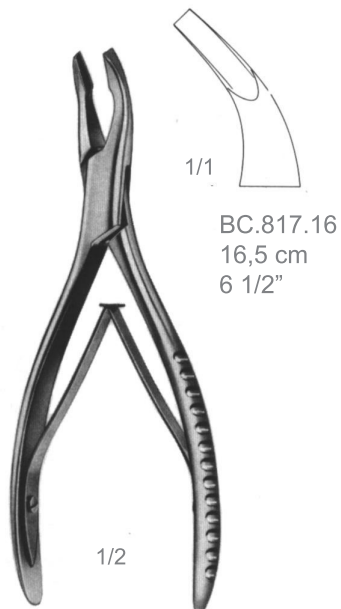

BC.817.16
16,5 cm
6 1/2"

BC.817.16
Mead
Bone Rongeur Forceps

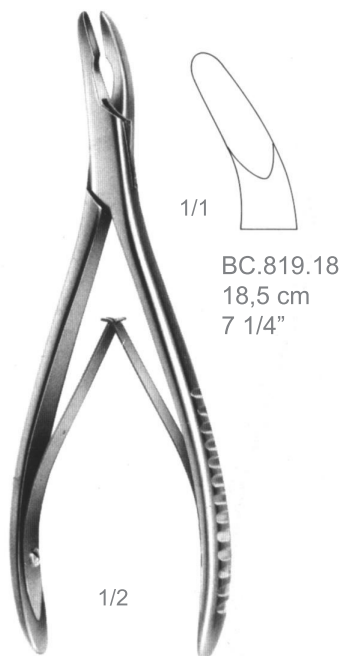

BC.819.18
18,5 cm
7 1/4"

BC.819.18
Hartmann
Bone Rongeur Forceps



BC.826.18
BC.829.18
Jansen
Bone Rongeur Forceps

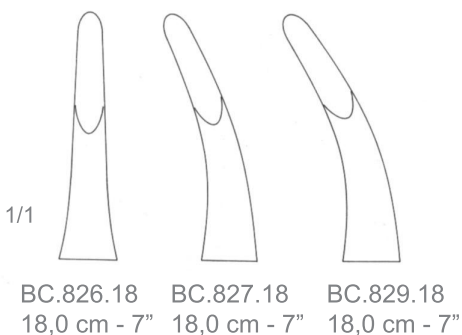

BC.826.18 18,0 cm - 7"
BC.827.18 18,0 cm - 7"
BC.829.18 18,0 cm - 7"

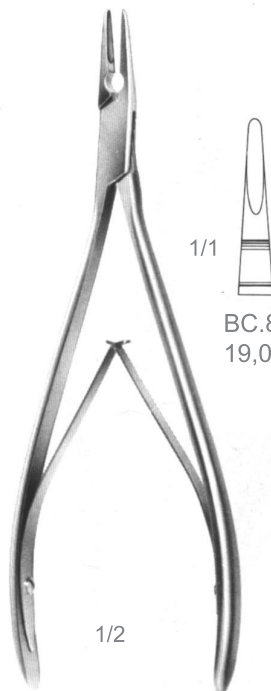

BC.832.19
Lempert
Bone Rongeur Forceps

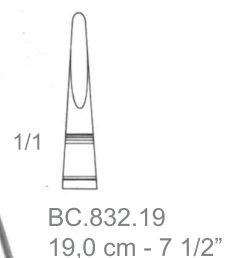

BC.832.19
19,0 cm - 7 1/2"

BC

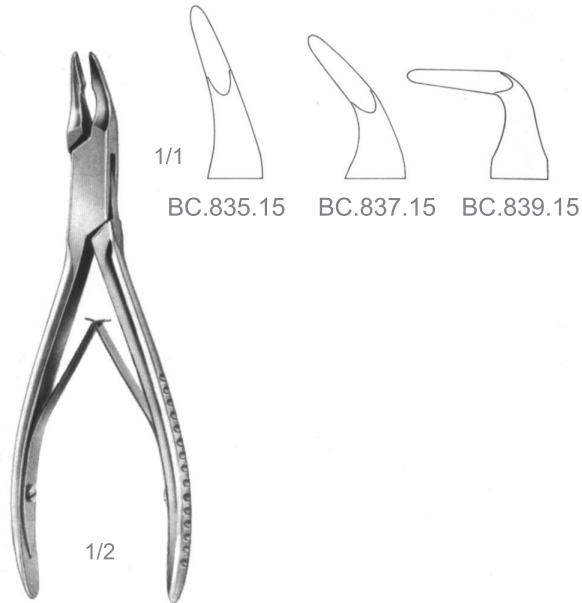

BC.835.15
BC.839.15
Blumenthal
Bone Rongeur Forceps

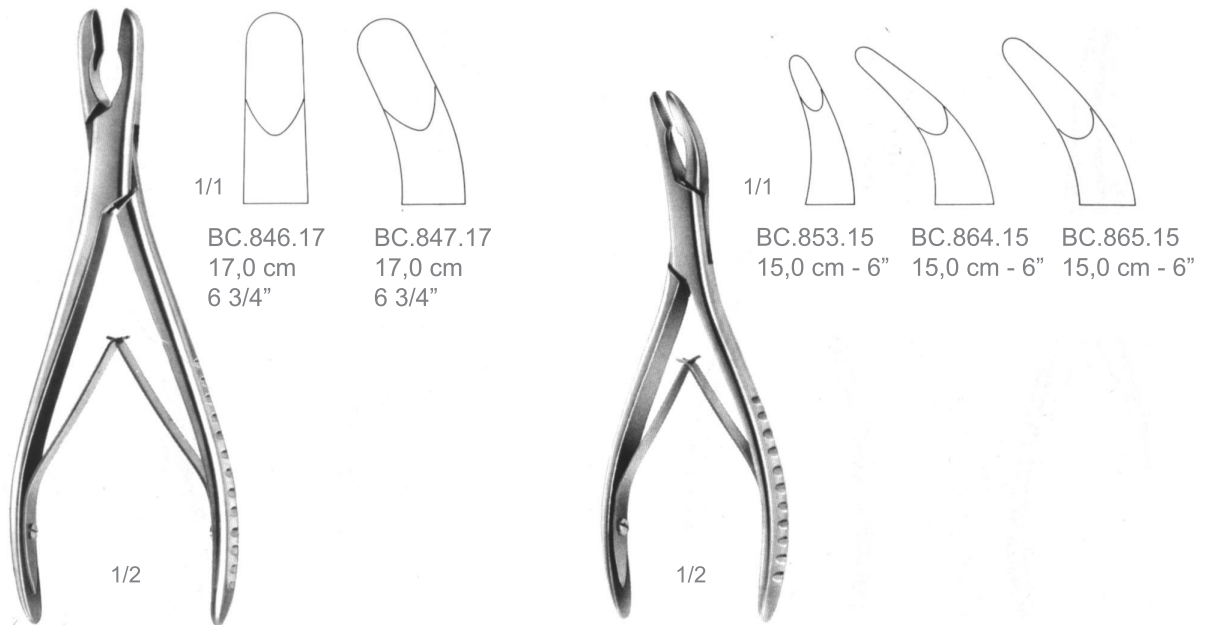

BC.846.17
BC.847.17
Luer
Bone Rongeur Forceps

BC.853.15
BC.865.15
Luer
Bone Rongeur Forceps

Bone Rongeur Forceps

HOLMEIBELZANGEN - PINZAS-GUBIAS

Kolpen

BONE SURGERY
KNOCHENCHIRURGIE
CIRUGÍA OSEA

BC

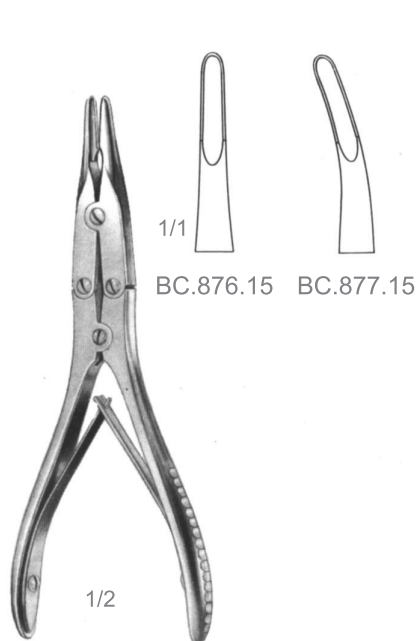

BC.876.15
BC.877.15
Böhler
Bone Rongeur Forceps

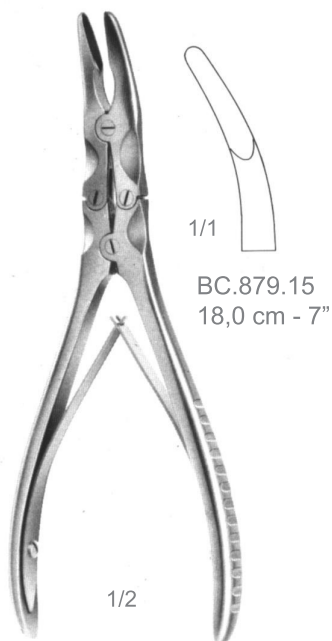

BC.879.15
Bayer
Bone Rongeur Forceps



BC.881.18
Zaufal-Jansen
Bone Rongeur Forceps



BC.883.17
Mayfield
Bone Rongeur Forceps



BC.885.20
Marquardt
Bone Rongeur Forceps

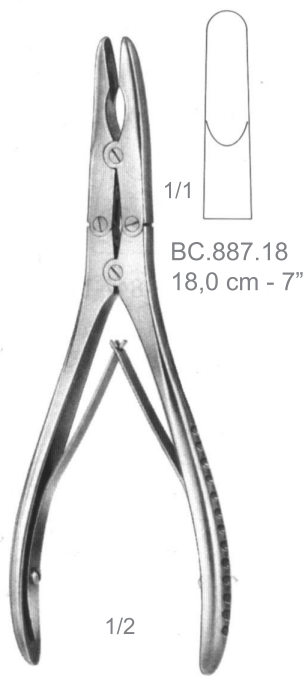

BC.887.18
Ruskin
Bone Rongeur Forceps



BC.893.23
Ruskin
Bone Rongeur Forceps

BC



BC.895.22
Semb
Bone Rongeur Forceps

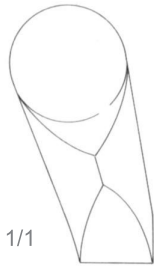

BC.895.22
22,5 cm - 9"



BC.897.23
Stille
Bone Rongeur Forceps



BC.897.23
23,0 cm - 9"



BC.899.02/04
Echlin
Bone Rongeur Forceps



BC.899.02
23,0 cm - 9"

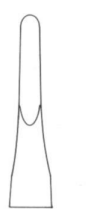

BC.899.03
23,0 cm - 9"



BC.899.04
23,0 cm - 9"

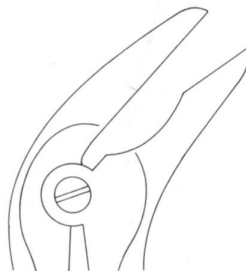

BC.901.23
Stille-Ruskin
Bone Rongeur Forceps

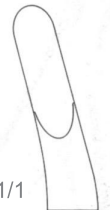

BC.901.23
23,0 cm - 9"

Bone Rongeur Forceps

HOLMEIBELZANGEN - PINZAS-GUBIAS

Kolpen

BONE SURGERY
KNOCHENCHIRURGIE
CIRUGÍA OSEA

BC

BC.905.24 BC.907.24
24,0 cm - 9 1/2" 24,0 cm - 9 1/2"

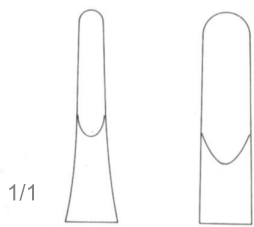

BC.909.24
24,0 cm - 9 1/2"

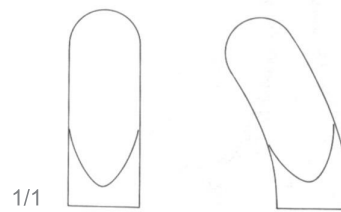

BC.910.22 BC.911.22
22,0 cm - 8 3/4" 22,0 cm - 8 3/4"



1/2

BC.905.24
BC.907.24
Leksell-Stillie
Bone Rongeur Forceps



1/2

BC.909.24
Frykholm
Bone Rongeur Forceps



1/2

BC.910.22
BC.911.22
Stillie-Luer
Bone Rongeur Forceps

BC

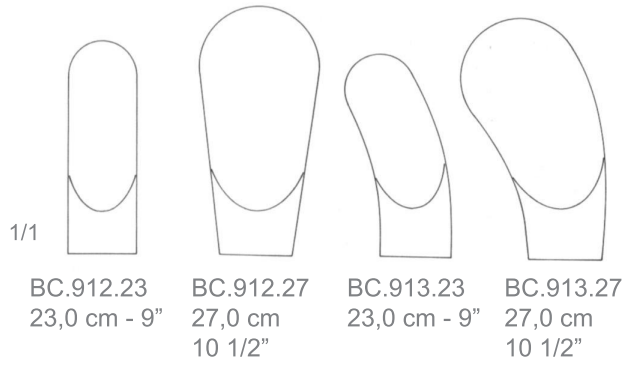

BC.916.30
30,0 cm - 12"

BC.918.30
30,0 cm - 12"

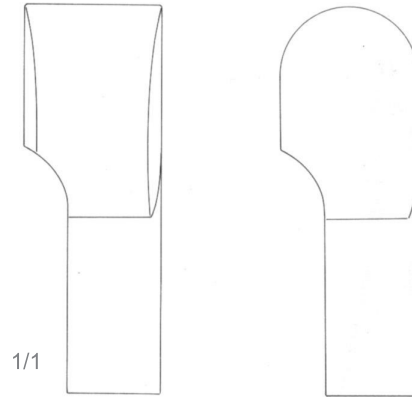

BC.912.23
BC.913.27
Stille-Luer
Bone Rongeur Forceps



BC.916.30
BC.918.30
Sauerbruch
Bone Rongeur Forceps

Bone Cutting Forceps

KNOCHENSPLITTERZANGEN - PINZAS CORTANTES PARA HUESOS

Kolpen

BONE SURGERY
KNOCHENCHIRURGIE
CIRUGÍA OSEA

BC

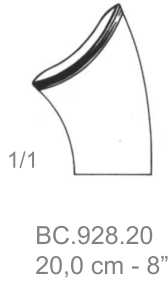
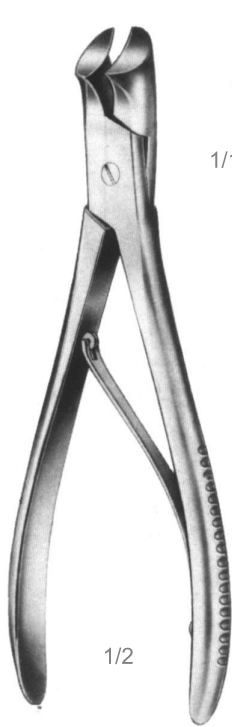

BC.928.20
Markwalder
Bone Cutting Forceps

1/2

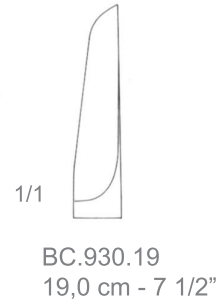

BC.930.19
Cottle-Kazanjan
Bone Cutting Forceps

1/2



BC.934.14
14,0 cm - 5 1/2"



BC.934.17
17,0 cm - 6 3/4"



BC.935.14
14,0 cm - 5 1/2"



BC.935.17
17,0 cm - 6 3/4"

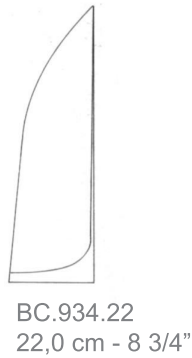
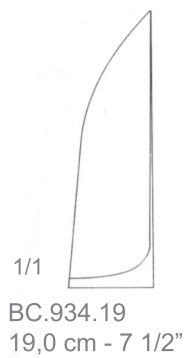

BC.934.14/22
Liston
Bone Cutting Forceps

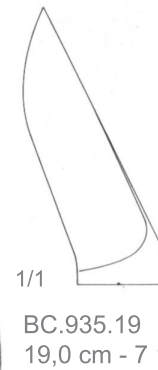

BC.935.14/22
Liston
Bone Cutting Forceps

BC

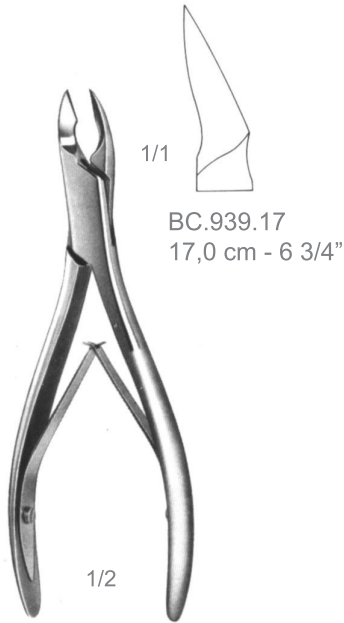

BC.939.17
17,0 cm - 6 3/4"

BC.939.17
Cleveland
Bone Cutting Forceps



BC.941.15
15,0 cm - 6"

BC.941.15
Cleveland
Bone Cutting Forceps



BC.942.12
12,0 cm - 4 3/4"

BC.942.12
Bone Cutting Forceps



BC.944.15
15,0 cm - 5 3/4"

BC.944.15
Bone Cutting Forceps



BC.946.15
15,0 cm - 5 3/4"

BC.946.15
Bone Cutting Forceps

Bone Cutting Forceps

KNOCHENSPLITTERZANGEN - PINZAS CORTANTES PARA HUESOS

Kolpen

BONE SURGERY
KNOCHENCHIRURGIE
CIRUGÍA OSEA

BC

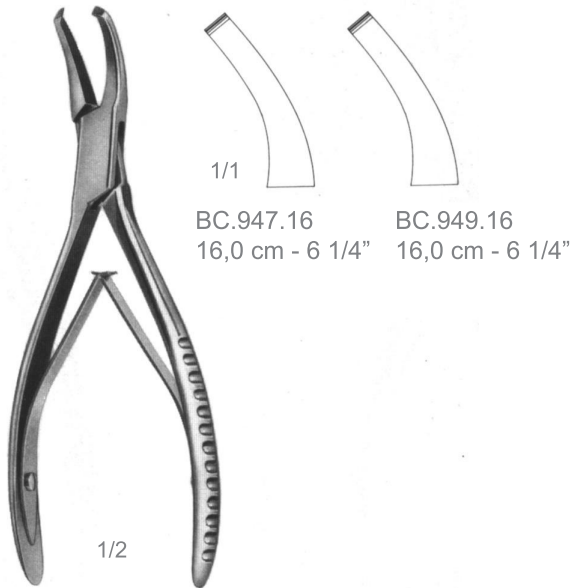

BC.947.16
BC.949.16
Cleveland
Bone Cutting Forceps

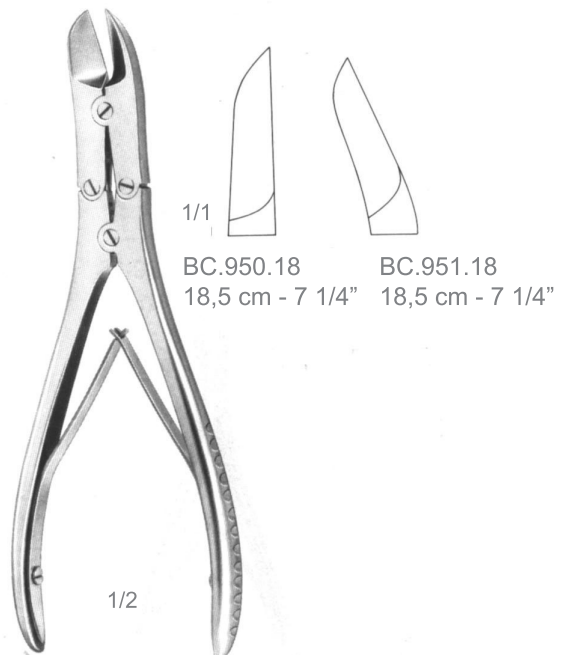

BC.950.18
BC.951.18
Ruskin-Liston
Bone Cutting Forceps

BC

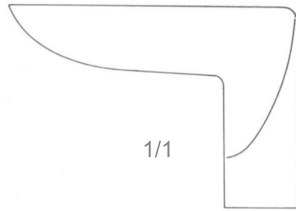

BC.952.27
27,0 cm - 10 1/2"



BC.952.27
Stille-Liston
Bone Cutting Forceps

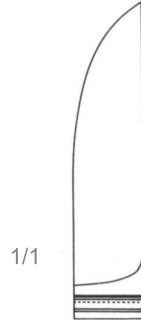

BC.954.27
27,0 cm - 10 1/2"



BC.954.27
Stille-Liston
Bone Cutting Forceps

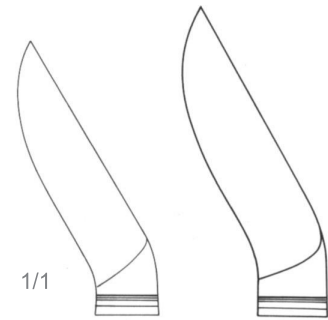

BC.955.23 BC.955.27
23,0 cm - 9 1/4" 27,0 cm - 10 1/2"



BC.955.23/27
Liston-Key
Bone Cutting Forceps

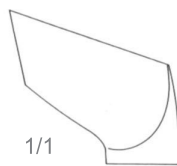

BC.957.27
27,0 cm - 10 1/2"

1/2

BC.957.27
Liston-Key
Bone Cutting Forceps

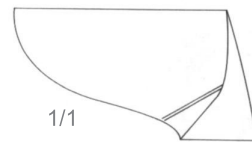

BC.959.24
24,0 cm - 9 1/2"

1/2

BC.959.24
Semb
Bone Cutting Forceps

Kolpen

BONE SURGERY
KNOCHENCHIRURGIE
CIRUGÍA OSEA

Lead Hands, Nail Instruments

BLEIHÄNDE, INSTRUMENTE FÜR FINGER- UND ZEHENNÄGEL -
MANOPLAS DE PLOMO, INSTRUMENTOS PARA UÑAS

BC

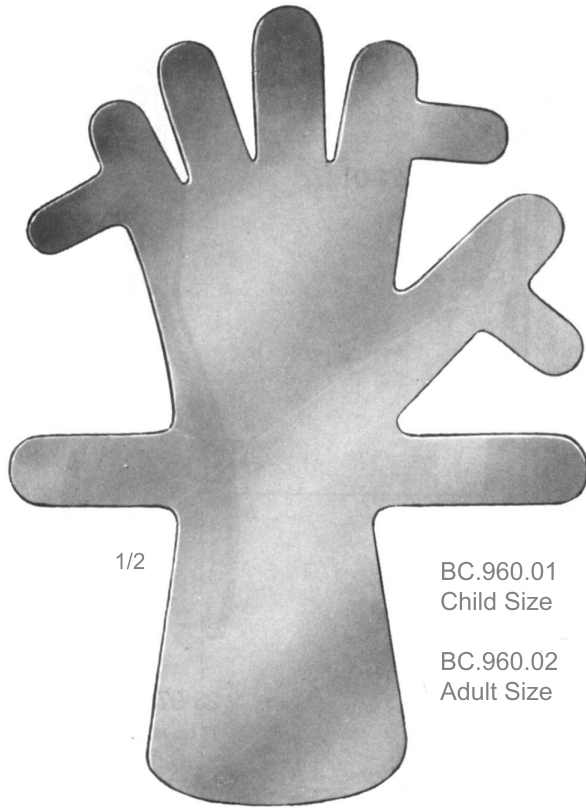

1/2

BC.960.01
Child Size

BC.960.02
Adult Size

BC.960.01/02
Lead Hands,
Nail Instruments



BC.964.10
10,0 cm - 4"

1/2

BC.964.10
Lead Hands,
Nail Instruments



1/2

BC.967.10
Martin-Ideal
Lead Hands,
Nail Instruments



1/1

BC.968.01



BC.968.02



BC.968.03

BC.968.00
Set

BC.968.00/03
Lead Hands,
Nail Instruments

Nail Instruments, Finger Ring Saws

INSTRUMENTE FÜR FINGER- UND ZEHENNÄGEL, FINGERRINGSÄGEN -
 INSTRUMENTOS PARA UÑAS, SIERRAS PARA ABRIR ANILLOS

Kolpen

BONE SURGERY
 KNOCHENCHIRURGIE
 CIRUGÍA OSEA

BC

BC.973.01



BC.970.17
 17,0 cm - 6 3/4"

1/2

BC.970.17
 Mod. Martin
 Nail Instruments,
 Finger Ring Saws

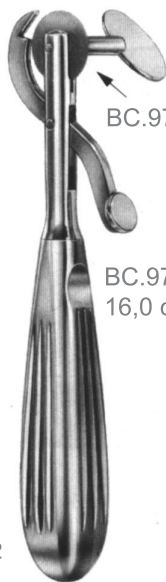

BC.974.01
 BC.972.16
 16,0 cm - 6 1/4"

1/2

BC.972.16
 Walton
 Nail Instruments,
 Finger Ring Saws



BC.976.01
 BC.975.17
 17,0 cm - 6 3/4"

1/2

BC.975.17
 Nail Instruments,
 Finger Ring Saws

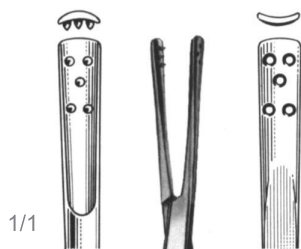

1/1

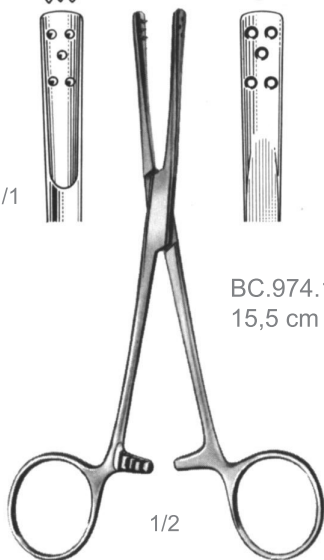

BC.974.16
 15,5 cm - 5 3/4"

1/2

BC.974.16
 Penner
 Nail Instruments,
 Finger Ring Saws

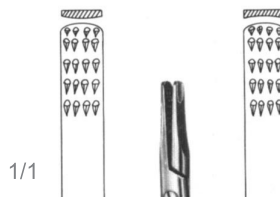

1/1

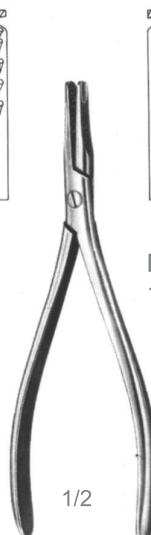

BC.978.13
 13,5 cm - 5 1/4"

1/2

BC.978.13
 Radolf
 Nail Instruments,
 Finger Ring Saws