

Kolpen

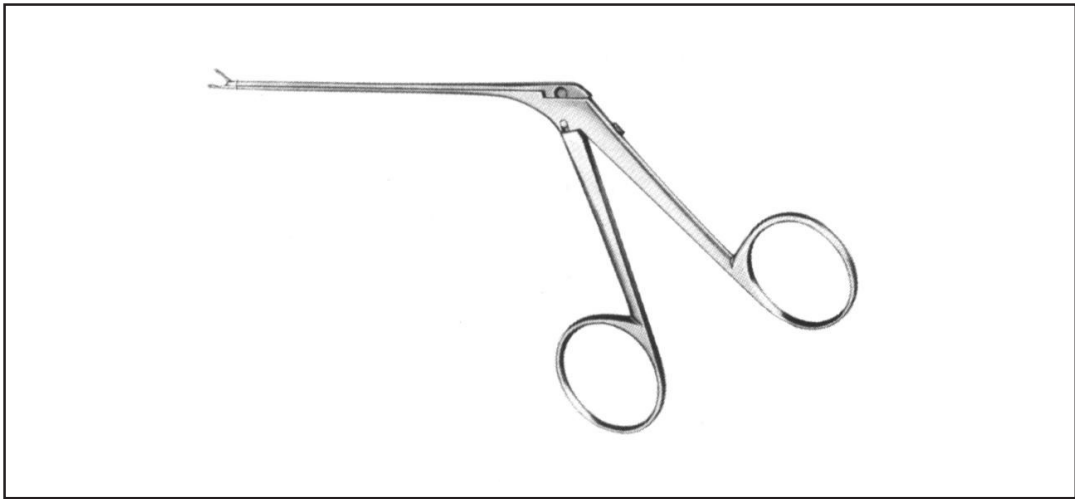

CF

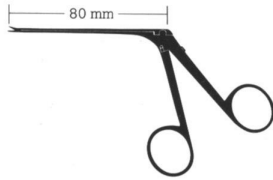

CF.001.01/09
Micro Ear Forceps

1/2

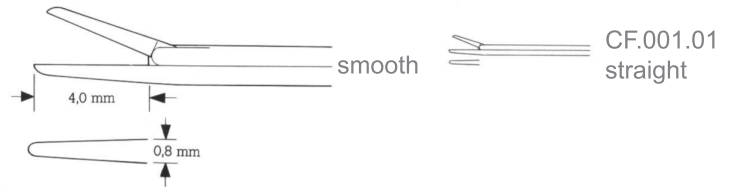

CF.001.01
straight

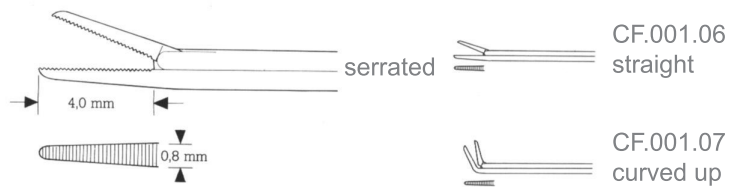

CF.001.06
straight

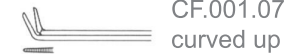

CF.001.07
curved up



CF.001.08
right



CF.001.09
left

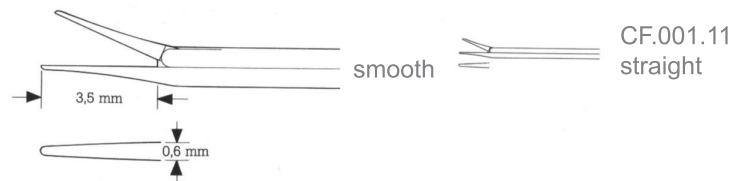

CF.001.11
straight



CF.001.16
straight

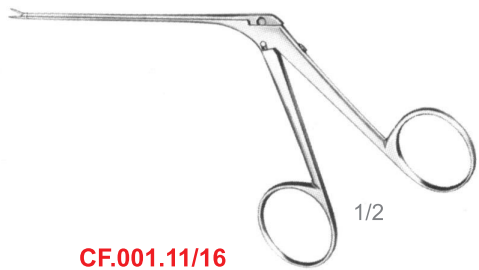

CF.001.11/16
Mini McGee Alligator
Micro Ear Forceps

1/2

1/1

Micro Ear Forceps

MIKRO-OHRZÄNGCHEN - MICRO-PINZAS AURICULARES

Kolpen

OTOLOGY
OTOLOGIE
OTOLOGÍA

CF

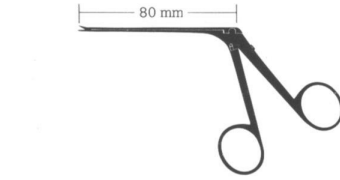
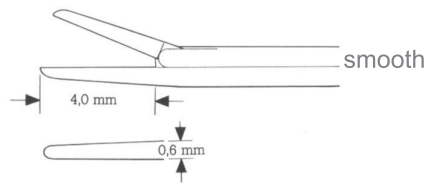

CF.001.21
4,0 x 0,6 mm
straight
1/1

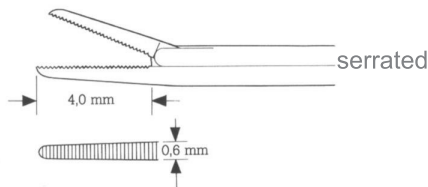

CF.001.26
4,0 x 0,6 mm
straight

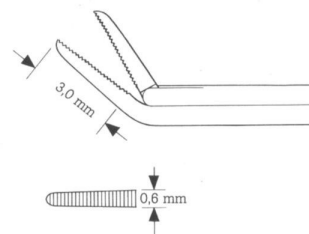

CF.001.27
3,0 x 0,6 mm
curved up

CF.001.28
3,0 x 0,6 mm
right

CF.001.29
3,0 x 0,6 mm
left
1/1

Kolpen

Micro Ear Forceps

MIKRO-ÖHRZÄNGCHEN - MICRO-PINZAS AURICULARES

OTOLOGY
OTOLOGIE
OTOLÓGIA

CF



CF.003.01/04
Micro Ear Forceps

1/2

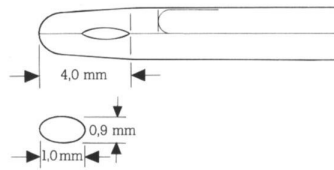

CF.003.01
straight

CF.003.02
curved up

CF.003.03
right

1/1 CF.003.04
left

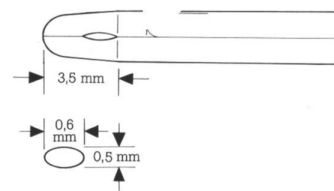

CF.003.11
straight

CF.003.12
curved up

CF.003.13
right

1/1 CF.003.14
left



CF.003.11/14
Micro Ear Forceps

1/2

Micro Ear Scissors

MIKRO-OHRSCHEREN - MICRO-TIJERAS AURICULARES

Kolpen

OTOLOGY
OTOLOGIE
OTOLOGÍA

CF

very delicate



CF.005.01/04
Bellucci
Micro Ear Scissors

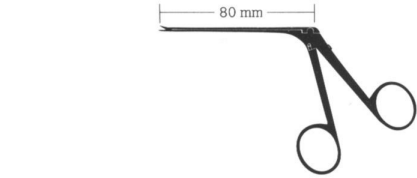
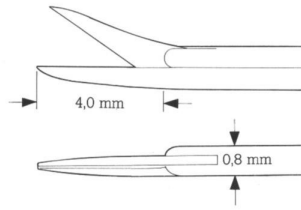

CF.005.01
straight

CF.005.02
curved up

CF.005.03
right

1/1 CF.005.04
left

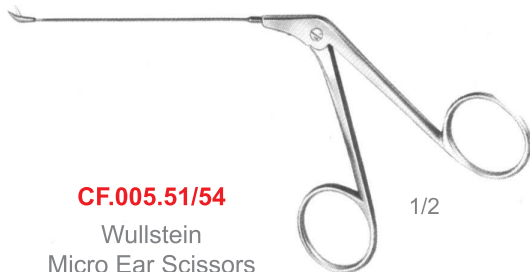
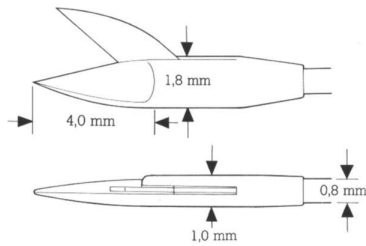

CF.005.51/54
Wullstein
Micro Ear Scissors

CF.005.51
straight

CF.005.52
curved up

CF.005.53
right

1/1 CF.005.54
left

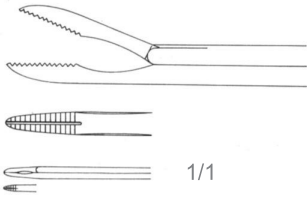
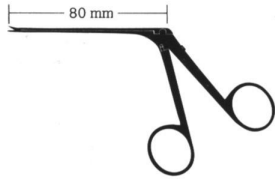

CF.010.01
Greven
Wire Closure
Forceps

1/2

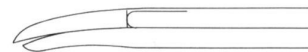

CF.010.06
Schuknecht
Wire Closure
Forceps

1/2

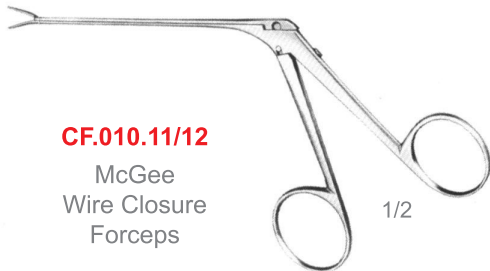
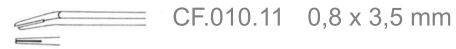
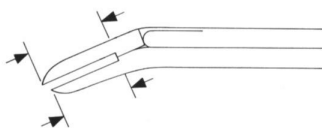

CF.010.11/12
McGee
Wire Closure
Forceps

1/2

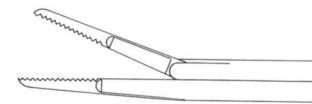

CF.010.16 left
CF.010.17 right



CF.010.16/17
Juers
Wire Closure
Forceps

1/2

Introduction Instrument, Crura and Malleus Nippers

EINFÜHRUNGSINSTRUMENT, CRURATOMIE- UND HAMMERKOPFZÄNGCHEN -
 PINZA PARA INTRODUCIR, PINZAS PARA LA CRURATOMÍA Y LA CABEZA
 DEL MARTILLO

Kolpen

OTOLOGY
 OTOLOGIE
 OTOLÓGIA

CF

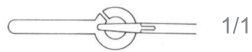
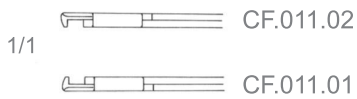
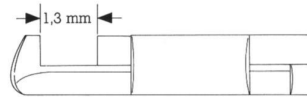

CF.013.01 - Instrument for introducing
 teflon pistons

Kolpen

Knives

OTOLOGY
OTOLOGIE
OTOLOGÍA

MESSER - CUCHILLOS

CF

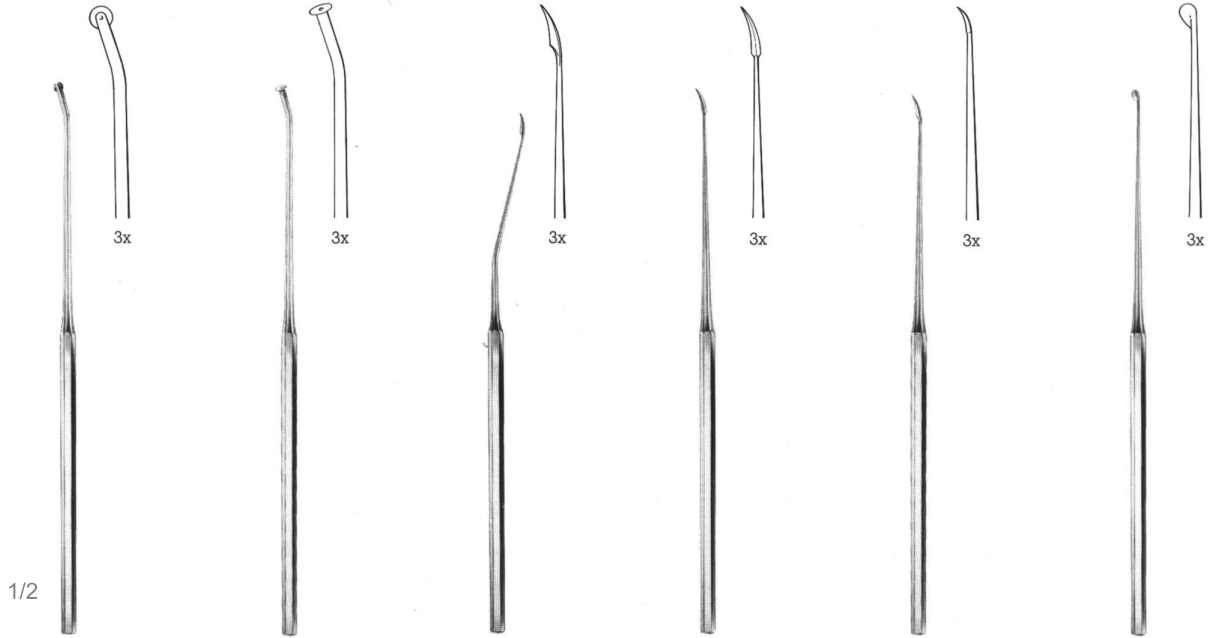

CF.020.01
Schuknecht
Knives

CF.020.02
Schuknecht
Knives

CF.020.06
Schuknecht
Knives

CF.020.11
Wullstein
Knives

CF.020.16
Tabb
Knives

CF.020.21
Plester
Knives

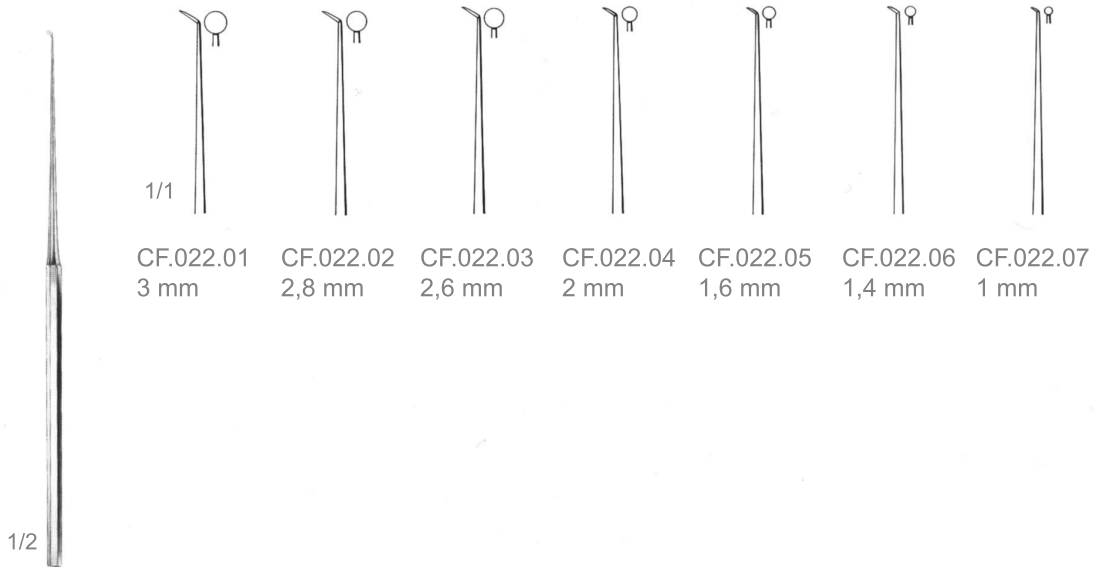

CF.022.01/07

Rosen
Knives

CF.020.01 - CF.020.02
CF.020.06 - CF.020.16
CF.020.21
CF.022.01 - CF.022.07

- Roller Knife
- Sickle Knife
- Flap Knife 3,5 mm Ø
- Round Knives

Needles, Picks and Hooks, straight shaft

NADELN UND HÄKCHEN, MIT GERADEM SCHAFT -
 AGUJAS Y GANCHOS CON VÁSTAGO RECTO

Kolpen

OTOLOGY
 OTOLOGIE
 OTOLÓGIA

CF



Barbara
 CF.024.01



CF.024.02



CF.024.03



Rosen
 CF.024.04



1/2



CF.024.06 0,3 mm
 CF.024.07 0,6 mm
 CF.024.08 1,0 mm



CF.024.11 0,3 mm
 CF.024.12 0,6 mm
 CF.024.13 1,0 mm
 CF.024.14 1,2 mm
 CF.024.15 1,5 mm
 CF.024.16 2,0 mm
 CF.024.17 2,5 mm



CF.024.21 0,3 mm
 CF.024.22 0,6 mm
 CF.024.23 1,0 mm
 CF.024.24 1,2 mm
 CF.024.25 1,5 mm
 CF.024.26 2,0 mm
 CF.024.27 2,5 mm

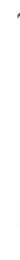

CF.024.31 0,5 mm
 CF.024.32 1,0 mm

CF.024.01/32

Barbara
 Needles, Picks and
 Hooks, straight shaft

CF



1/1



90°

CF.025.01 0,3 mm
CF.025.02 0,6 mm
CF.025.03 1,0 mm



90°

CF.025.06 0,3 mm
CF.025.07 0,6 mm
CF.025.08 1,0 mm



McGee
CF.027.01 0,5 mm
CF.027.02 1,0 mm



McGee
CF.027.11 0,5 mm
CF.027.12 1,0 mm

1/2

CF.025.01/12

Needles, Picks and
Hooks with angled shaft



Barbara
CF.029.01



Rosen
CF.029.06



1/1



25°

CF.029.11 0,3 mm
CF.029.12 0,6 mm
CF.029.13 1,0 mm



25°

CF.029.16 0,3 mm
CF.029.17 0,6 mm
CF.029.18 1,0 mm



45°

CF.029.21 0,3 mm
CF.029.22 0,6 mm
CF.029.23 1,0 mm



45°

CF.029.26 0,3 mm
CF.029.27 0,6 mm
CF.029.28 1,0 mm

1/2

CF.029.01/28

Needles, Picks and
Hooks with angled shaft

Dissectors, Measuring Rod, Elevators, Curettes, Mobilizer etc.

DISSEKTOREN, MEBSONDEN, RASPATORIEN, KÜRETTEN, HAKEN USW. -
 DISSECADOR, SONDAS DE MEDICIÓN, RASPATORIA, CUCHARILLAS,
 GANCHITOS ETC.

OTOLOGY
 OTOLOGIE
 OTOLÓGIA



CF.036.01/06

Fisch

Dissectors, Measuring Rod,
 Elevators, Curettes, Mobilizer

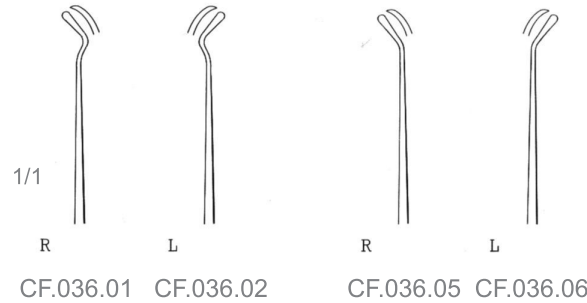

CF.036.21/51

Rosen

Dissectors, Measuring Rod,
 Elevators, Curettes, Mobilizer

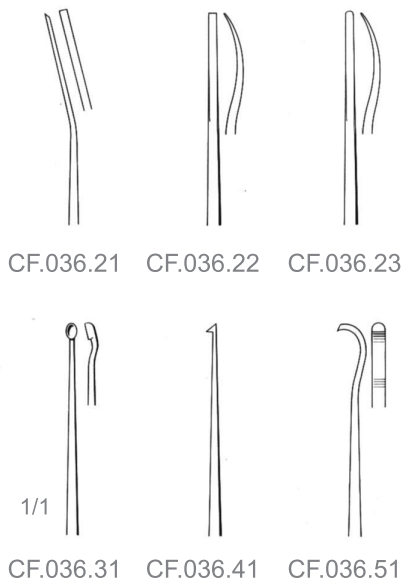

CF.038.01/04

House

Dissectors, Measuring Rod,
 Elevators, Curettes, Mobilizer

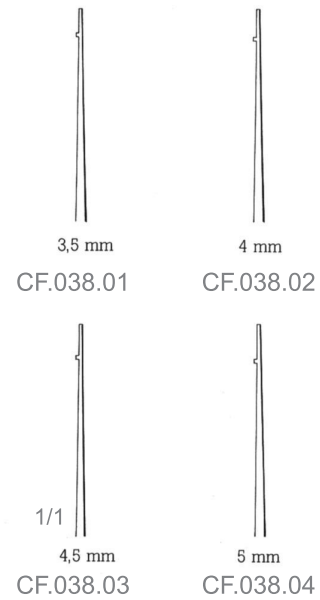

CF

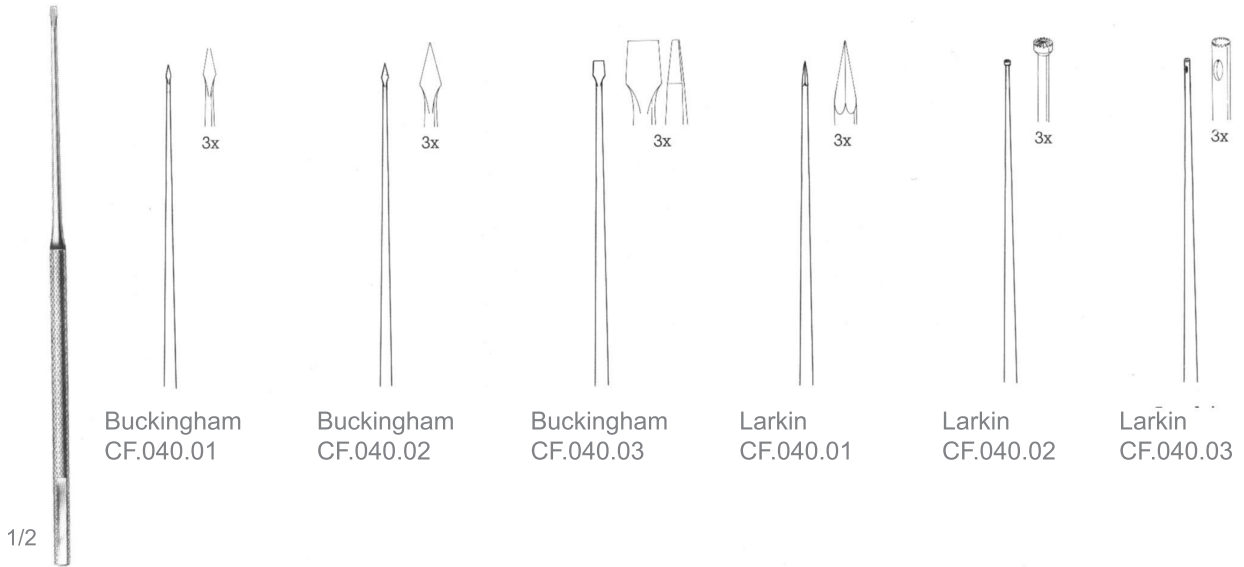

CF.040.01/03

Footplate Hand Instruments

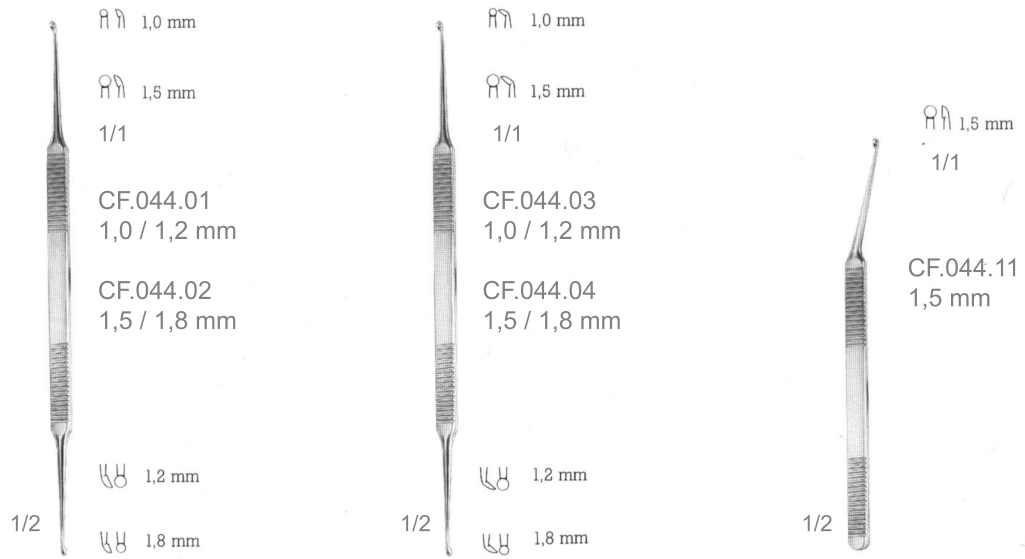

CF.044.01/02

House
Footplate Hand
Instruments

CF.044.03/04

House
Footplate Hand
Instruments

CF.044.11

Shea
Footplate Hand
Instruments

- CF.040.01 - Buckingham Hand drill, sharp, 0,5 mm
- CF.040.02 - ditto, 1,0 mm
- CF.040.03 - Buckingham Hand Chisel, flat, 1,5 mm
- CF.042.01 - Larkin perforator, trocar point, 0,8 mm Ø
- CF.042.02 - Larkin penetrator, 0,8 mm Ø
- CF.042.03 - Larkin trephine, 0,8 mm Ø

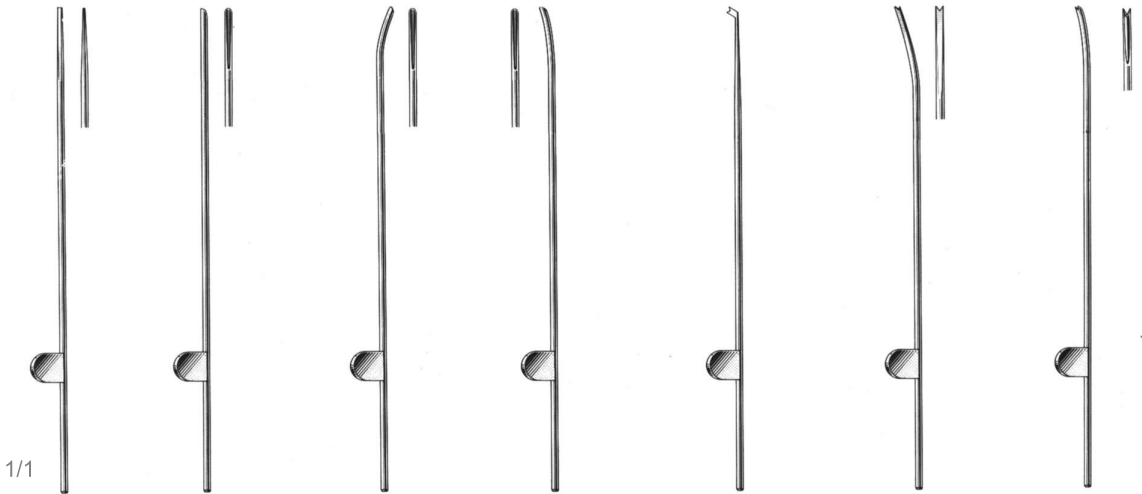

1/1

CF.080.01 7,0 cm - 3" CF.080.02 7,0 cm - 3" CF.080.03 7,0 cm - 3" CF.080.04 7,0 cm - 3" CF.080.05 7,0 cm - 3" CF.080.06 7,0 cm - 3" CF.080.07 7,0 cm - 3"

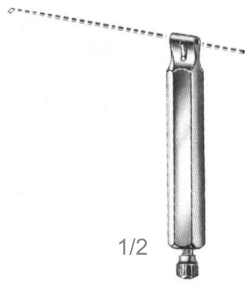

1/2

CF.080.10

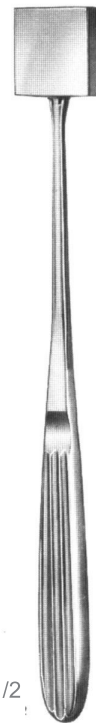

1/2

CF.080.15
 Footplate
 Instruments
 acc. to Heermann

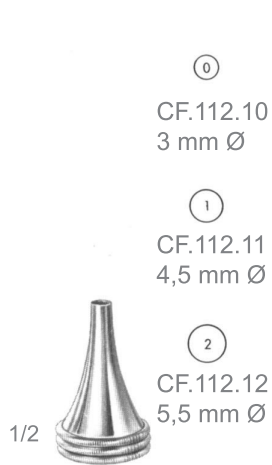

CF.112.03/12

Hartmann
Ear Specula

CF.112.03
Set of 3 pieces
Fig. 0 - 2
for children



**CF.114.03
CF.115.04**

Hartmann
Ear Specula

CF.114.03 CF.115.04
Set of 3 pieces Set of 4 pieces
Fig. 2 - 4 Fig. 1 - 4
for adults for adults

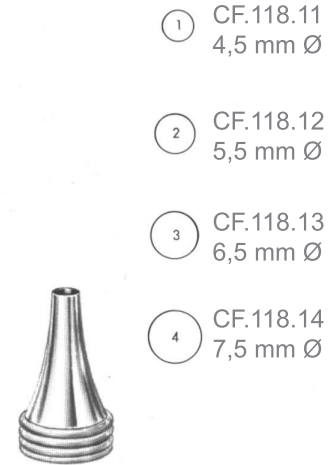

**CF.118.03
CF.119.04**

Toynbee
Ear Specula

CF.118.03 CF.119.04
Set of 3 pieces Set of 4 pieces
Fig. 2 - 4 Fig. 1 - 4
for adults for adults



CF.124.03/14

Gruber
Ear Specula

CF.124.03
Set of 3 pieces
Fig. 2 - 4
for adults



CF.127.04

Gruber
Ear Specula

CF.127.04
Set of 4 pieces
Fig. 1 - 4
for adults

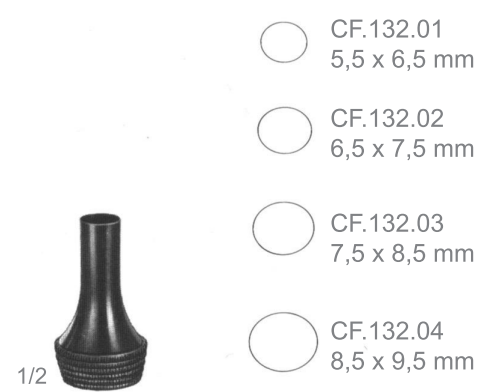

CF.132.00/06

Zöllner
Ear Specula

CF.132.00
Set of 6 pieces
Alu, black

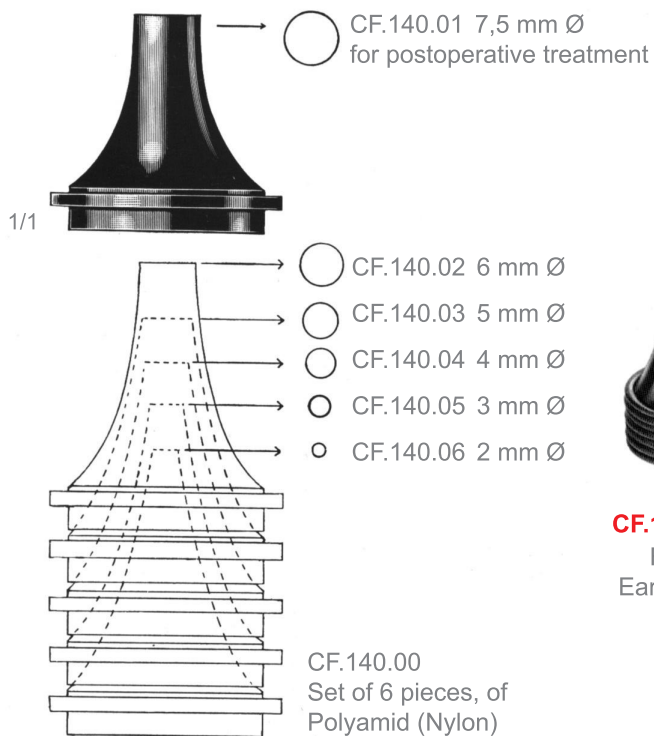

CF.140.00/06
Martin-Antireflex
Ear Specula



CF.134.01/07
Farrior
Ear Specula

- 1 CF.134.01 5,5 mm
- 2 CF.134.02 6,5 mm
- 3 CF.134.03 7,5 mm
- 4 CF.134.04 8,5 mm
- 5 CF.134.05 9,5 mm
- 6 CF.134.06 10,5 mm
- 7 CF.134.07 11,5 mm

black



CF.142.00
Mod. Martin
Ear Specula

CF.142.00
Speculum Holder
for CF.140.00

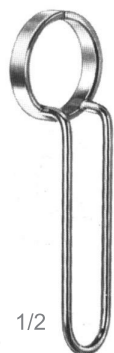

CF.143.00
Ear Specula

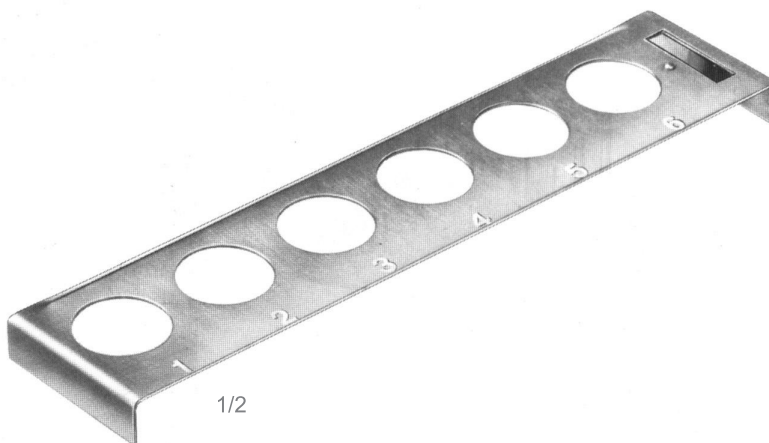

CF.144.00
Ear Specula

Kolpen

Ear Specula

OTOLOGY
OTOLOGIE
OTOLOGÍA

OHRSPEKULA - ESPÉCULOS AURICULARES

CF



CF.150.03
Siegle
Ear Specula

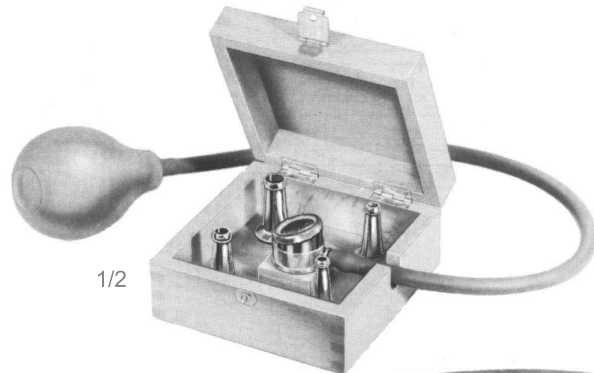

1/2

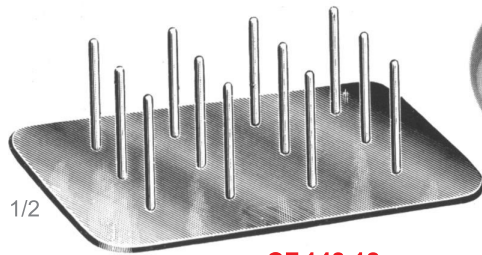

1/2

CF.148.12
Ear Specula



CF.154.04
CF.157.04
Bruenings
Ear Specula

1/2

- CF.148.12 -Metal Support for Specula
- CF.150.03 -Pneumatic Otoscope with 3 ear specual and rubber tube with bulb
- CF.154.04 -ditto, improved pattern, with 4 specula and suction head for massage, complete with rubber tube and bulb in wooden case
- CF.157.01 -Rubber bulb only
- CF.157.02 -Wooden case only
- CF.157.04 -Set of 4 Ear Specula only

CF.170.07
C₋₂ 16

Double-contra

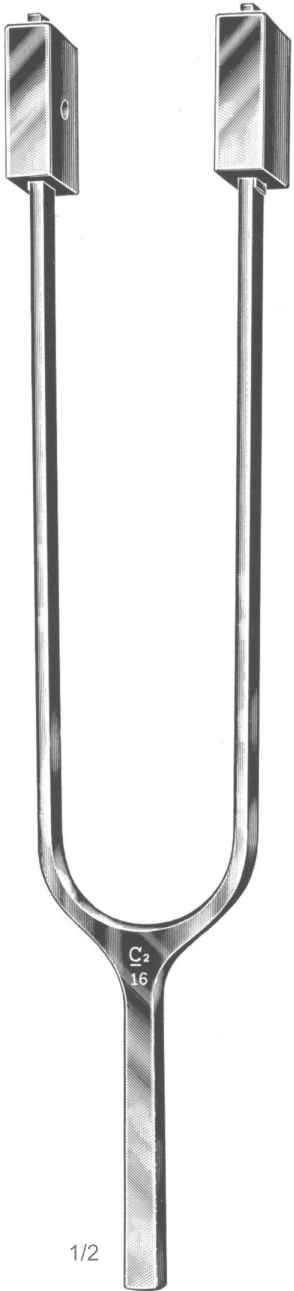

CF.170.07
French
Tuning Forks

CF.172.08
C₋₁ 32

Contra

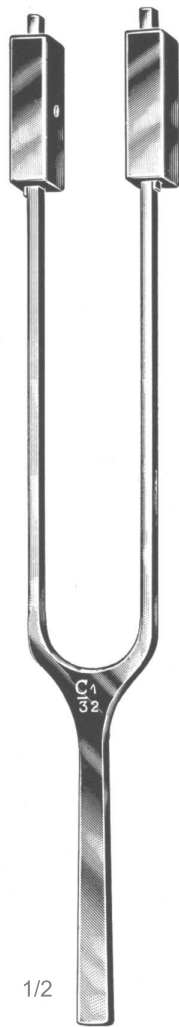

CF.172.08
French
Tuning Forks

CF.174.09
C 64

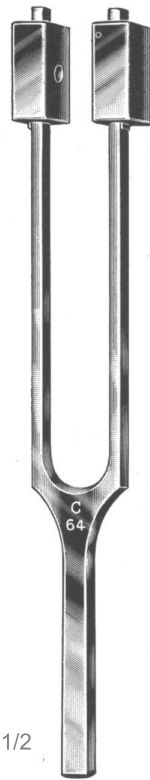

CF.174.09
Hartmann
Tuning Forks

CF.175.10
C 128

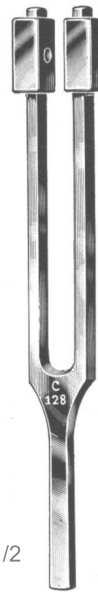

CF.175.10
Hartmann
Tuning Forks

CF.177.11
C¹ 256

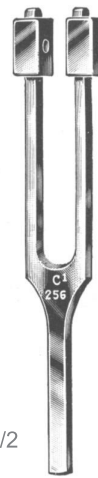

CF.177.11
Hartmann
Tuning Forks

CF

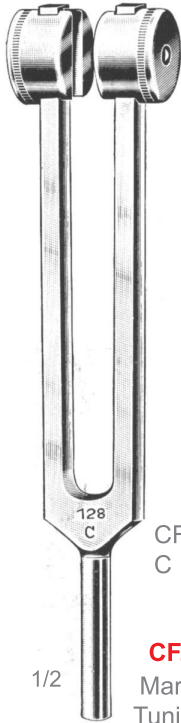

CF.180.10
C 128

CF.180.10
Martin-Alloy
Tuning Forks

1/2

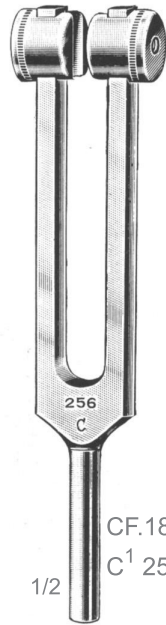

CF.182.11
C¹ 256

CF.182.11
Martin-Alloy
Tuning Forks

1/2

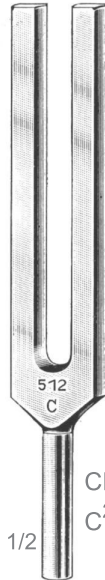

CF.184.12
C² 512

CF.184.12
Martin-Alloy
Tuning Forks

1/2

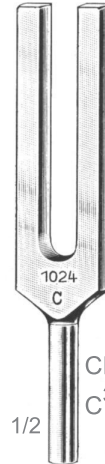

CF.186.13
C³ 1024

CF.186.13
Martin-Alloy
Tuning Forks

1/2

CF.188.14
C⁴ 2048



CF.188.14
Martin-Alloy
Tuning Forks

1/2



CF.189.10
C 128

CF.189.10
Hartmann
Tuning Forks

1/2

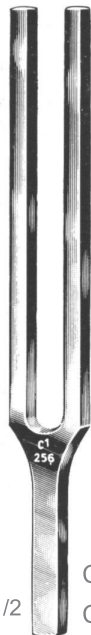

CF.192.11
C¹ 256

CF.192
Hartmann
Tuning Forks

1/2



CF.194.12
C² 512

CF.194.12
Hartmann
Tuning Forks

1/2



CF.196.13
C³ 1024

CF.196.13
Hartmann
Tuning Forks

1/2



CF.198.14
C⁴ 2048

CF.198.14
Hartmann
Tuning Forks

1/2

CF.200.15
C⁵ 4096



CF.200.15
Hartmann
Tuning Forks

1/2

Tuning Forks

STIMMGABELN - DIAPASONES

Kolpen

OTOLOGY
OTOLOGIE
OTOLOGÍA

CF

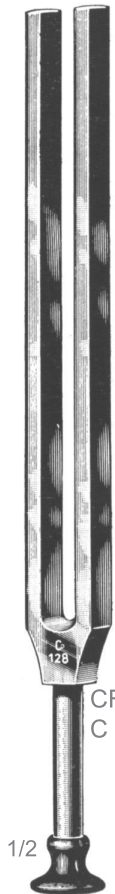

CF.210.10
C 128

1/2
CF.210.10
Lucae
Tuning Forks

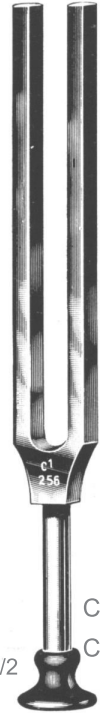

CF.212.11
1/2 C¹ 256

CF.212.11
Lucae
Tuning Forks



CF.214.12
1/2 C² 512

CF.214.12
Lucae
Tuning Forks



CF.216.13
1/2 C³ 1024

CF.216.13
Lucae
Tuning Forks

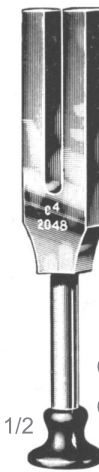

CF.218.14
1/2 C⁴ 2048

CF.218.14
Lucae
Tuning Forks



CF.220.15
C⁵ 4096

CF.220.15
Lucae
Tuning Forks

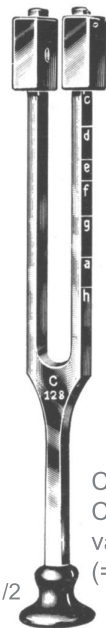

CF.221.10
C 128
variable up to h
(= Eng. b)

1/2
CF.221.10
Lucae
Tuning Forks

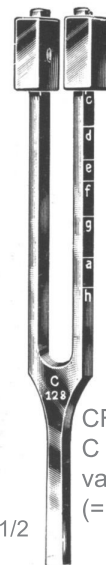

CF.222.10
C 128
variable up to h
(= Eng. b)

1/2
CF.222.10
Hartmann
Tuning Forks

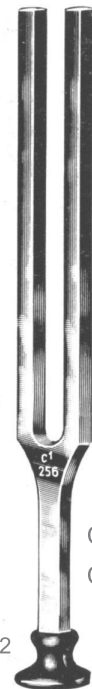

CF.223.11
C¹ 256

1/2
CF.223.11
Hartmann
Tuning Forks

CF

CF.224.10
 C 64 / C 128
 with clamps = C 64
 without clamps = C 128

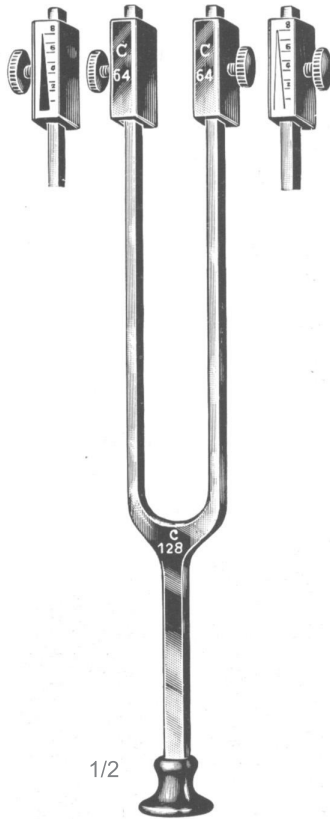

CF.224.10
 Rydel-Seiffer
 Tuning Forks

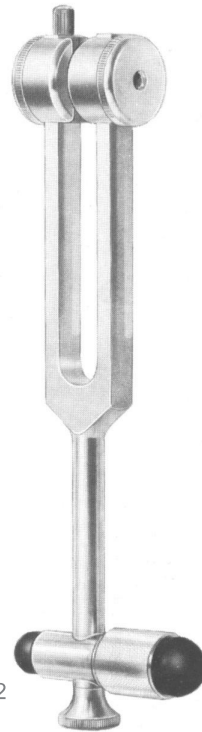

CF.226.00
 Tuning Forks

CF.230.59
 A 109
 Variable up to g

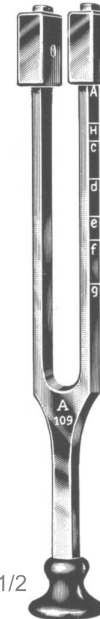

CF.230.59
 Koenig
 Tuning Forks

CF.234.61
 A¹ 440



CF.234.61
 Tuning Forks

CF.224.10 - Also for neurology
 CF.226.00 - Tuning fork for neurological examinations, with percussion
 hammer, pinwheel, brush and needle

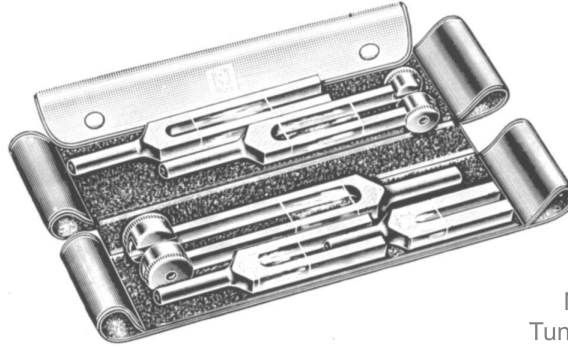

CF.250.00
Martin-Alloy
Tuning Forks Sets

CF.250.00 -Set of 5 Alloy Tuning Forks
CF.180.10, CF.182.11,
CF.184.12, CF.186.13 and
CF.188.14, in plastic pouch

CF.255.00 -Set of 5 Tuning Forks
CF.175.10, CF.177.11,
CF.194.12, CF.196.13 and
CF.198.14, in velvet-lined case

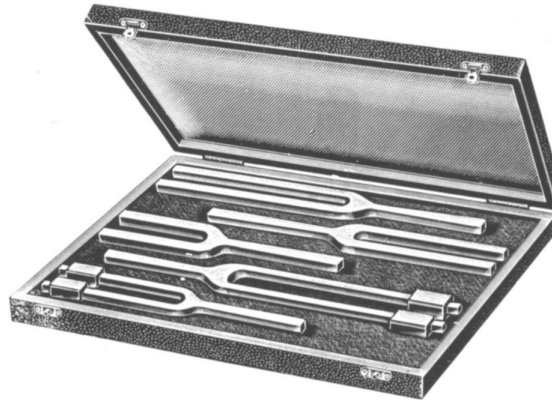

CF.255.00
CF.256.00
Hartmann
Tuning Forks Sets

CF.256.00 -Set of 6 Tuning Forks
CF.175.10, CF.177.11,
CF.194.12, CF.196.13,
CF.198.14 and CF.200.15,
in velvet-lined case

CF.258.00 -Set of 8 Tuning Forks
CF.172.08, CF.174.09,
CF.175.10, CF.177.11,
CF.194.12, CF.196.13,
CF.198.14 and CF.200.15
in velvet-lined case



CF.258.00
Hartmann-Ostmann
Tuning Forks Sets

CF

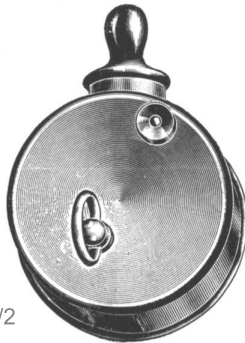

1/2

CF.304.00

Barany
Noise Apparatus,
Eustachian Catheters

CF.304.01
olive seule



1/2

CF.304.01

Noise Apparatus,
Eustachian Catheters

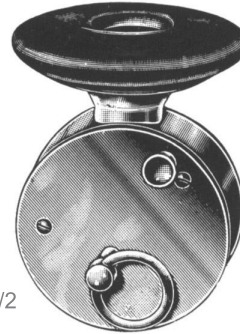

1/2

CF.306.00

Barany
Noise Apparatus,
Eustachian Catheters

CF.306.01
rubber only

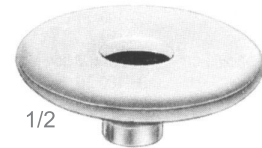

1/2

CF.306.01

Noise Apparatus,
Eustachian Catheters

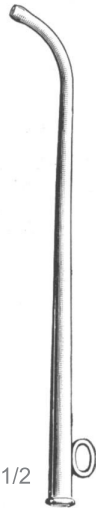

1/2

CF.321.00/05

Hartmann
Noise Apparatus,
Eustachian Catheters



1/1

CF.321.00

CF.321.01

CF.321.02

CF.321.03

CF.321.04

CF.321.05

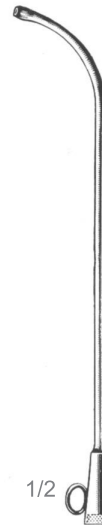

1/2

CF.327.01/05

Itard
Noise Apparatus,
Eustachian Catheters



1/1

CF.327.01

CF.327.02

CF.327.03

CF.327.04

CF.327.05

Ear Polypus Snares, Ear Dressing Forceps

POLYPENSCHNÜRER, ÖHRPINZETTEN -
POLIPÓTOMOS, PINZAS AURICULARES

Kolpen

OTOLOGY
OTOLOGIE
OTOLOGÍA

CF

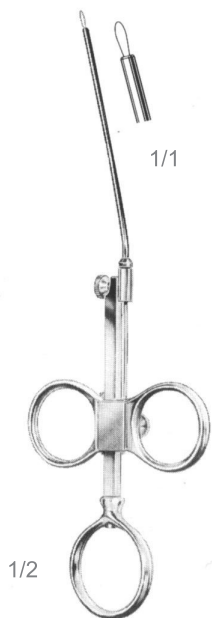

CF.351.16
Krause
Ear Polypus Snares,
Ear Dressing Forceps

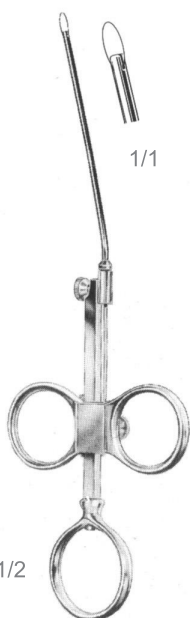

CF.353.16
Krause-Voss
Ear Polypus Snares,
Ear Dressing Forceps

CF.358.30 0,3 mm Ø
CF.358.40 0,4 mm Ø

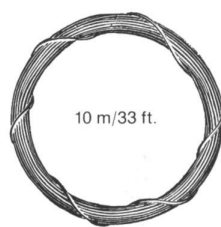

CF.358.30/40
Ear Polypus Snares,
Ear Dressing Forceps

CF.359.20 0,2 mm Ø



CF.359.20
Ear Polypus Snares,
Ear Dressing Forceps



CF.371.11
11,0 cm -
4 1/2"
CF.371.11
Troeltsch (Wilde)
Ear Polypus Snares,
Ear Dressing Forceps



CF.375.12
12,0 cm -
4 3/4"
CF.375.12
Troeltsch (Wilde)
Ear Polypus Snares,
Ear Dressing Forceps



CF.381.13
13,0 cm -
5"
CF.381.13
Troeltsch (Wilde)
Ear Polypus Snares,
Ear Dressing Forceps



CF.391.14
Lucae
Ear Polypus Snares,
Ear Dressing Forceps



CF.395.16
16,0 cm - 6 1/4"
CF.395.20
20,0 cm - 8"
CF.395.16/20
Jansen
Ear Polypus Snares,
Ear Dressing Forceps

CF.358.30 - CF.358.40
CF.359.20

- Steel Wire for Ear Snares
- Steel Wire Loops for Ear Snares, pre-shaped, in bundles of 1 dozen each

CF

CF.401.12
12,0 cm - 4 3/4"

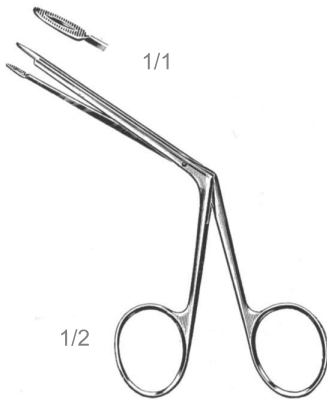

CF.401.12
Littauer
Ear Polypus Forceps,
Foreign Body Levers

CF.405.12
12,0 cm - 4 3/4"
fine pattern

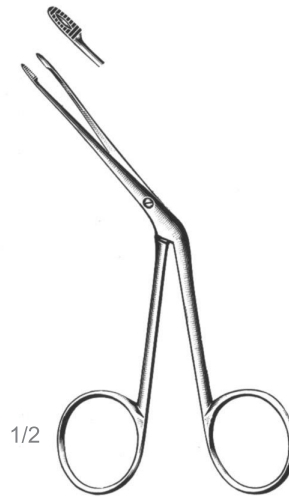

CF.405.12
Hartmann
Ear Polypus Forceps,
Foreign Body Levers

CF.407.14
14,0 cm - 5 1/2"
standard pattern

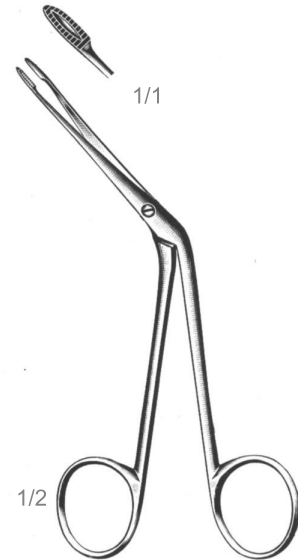

CF.407.14
Hartmann
Ear Polypus Forceps,
Foreign Body Levers



CF.416.11
Buck
Ear Polypus Forceps,
Foreign Body Levers



CF.418.10
Quire
Ear Polypus Forceps,
Foreign Body Levers

CF.425.08
8,5 cm - 3 1/2"



CF.425.08
Hartmann-Wullstein
Ear Polypus Forceps

CF.427.08
8,5 cm - 3 1/2"



CF.427.08
Hartmann-Wullstein
Ear Polypus Forceps

CF.430.08 8,5 cm - 3 1/2"
CF.430.14 14,0 cm - 5 1/2"
CF.430.16 16,5 cm - 6 1/2"



CF.430.08/16
Hartmann
Ear Polypus Forceps

CF.431.08 8,5 cm - 3 1/2"
CF.431.14 14,0 cm - 5 1/2"

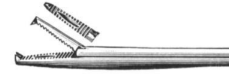

CF.431.08/14
Hartmann
Ear Polypus Forceps

CF.434.09
9,0 cm - 3 1/2"



CF.434.09
Hartmann-Noyes
Ear Polypus Forceps

CF.435.09
9,0 cm - 3 1/2"

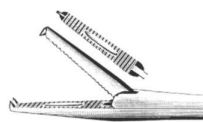

CF.435.09
Hartmann-Noyes
Ear Polypus Forceps

CF.436.08
8,5 cm - 3 1/2"



CF.436.08
Hartmann-Weingärtner
Ear Polypus Forceps

CF.440.08
8,5 cm - 3 1/2"



CF.440.08
Hartmann
Ear Polypus Forceps

- o 2 mm CF.442.81 2 mm Ø
- o 2,5 mm CF.442.82 2,5 mm Ø
- o 3 mm CF.442.83 3 mm Ø



CF.442.81/83
Hartmann
Ear Polypus Forceps

CF.445.08
8,5 cm - 3 1/2"

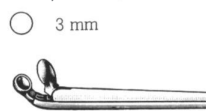

CF.445.08
Hartmann
Ear Polypus Forceps

CF.448.08
8,5 cm - 3 1/2"



CF.448.08
Struempel
Ear Polypus Forceps

CF.450.08
8,5 cm - 3 1/2"

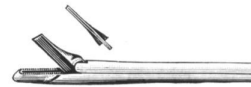

CF.450.08
Hartmann
Ear Polypus Forceps

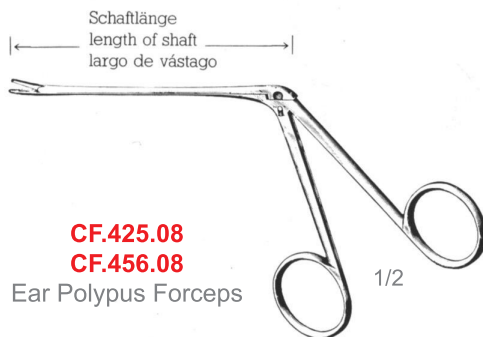

CF.454.08
8,5 cm - 3 1/2"



CF.454.08
Hartmann
Ear Polypus Forceps

CF.456.08
8,5 cm - 3 1/2"

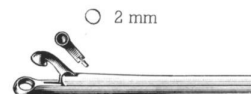

CF.456.08
Hartmann-Hoffmann
Ear Polypus Forceps

CF



CF.461.17
Citelli
Punches



CF.463.19
Beyer
Punches

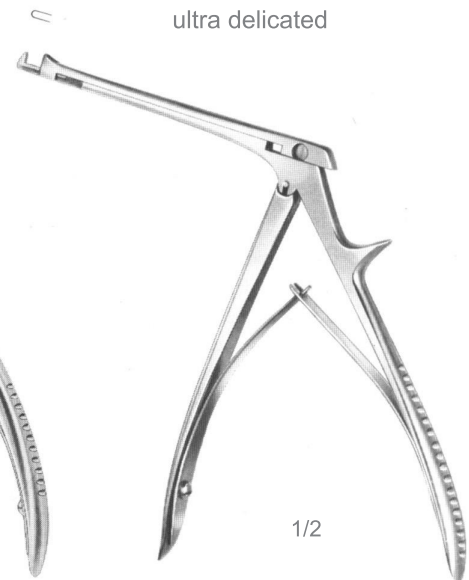

CF.466.14
Beyer
Punches



CF.491.13
Langenbeck
Curettes

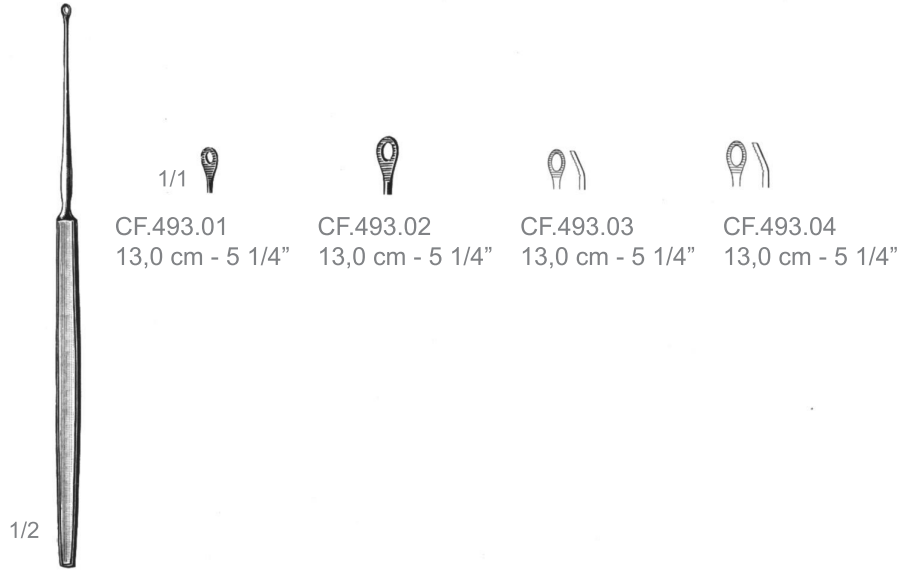

CF.493.01/04
Shapleigh
Curettes



CF.495.01/14
CF.496.01/14
Buck
Curettes

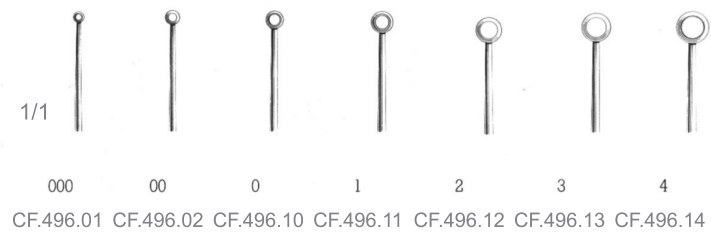

CF.495.01/14
CF.496.01/14
16,5 cm - 6 1/2"

Kolpen

Curettes and Spoons

OTOLOGY
OTOLOGIE
OTOLÓGIA

KÜRETTEN, LÖFFEL - CURETAS Y CUCHARILLAS

CF

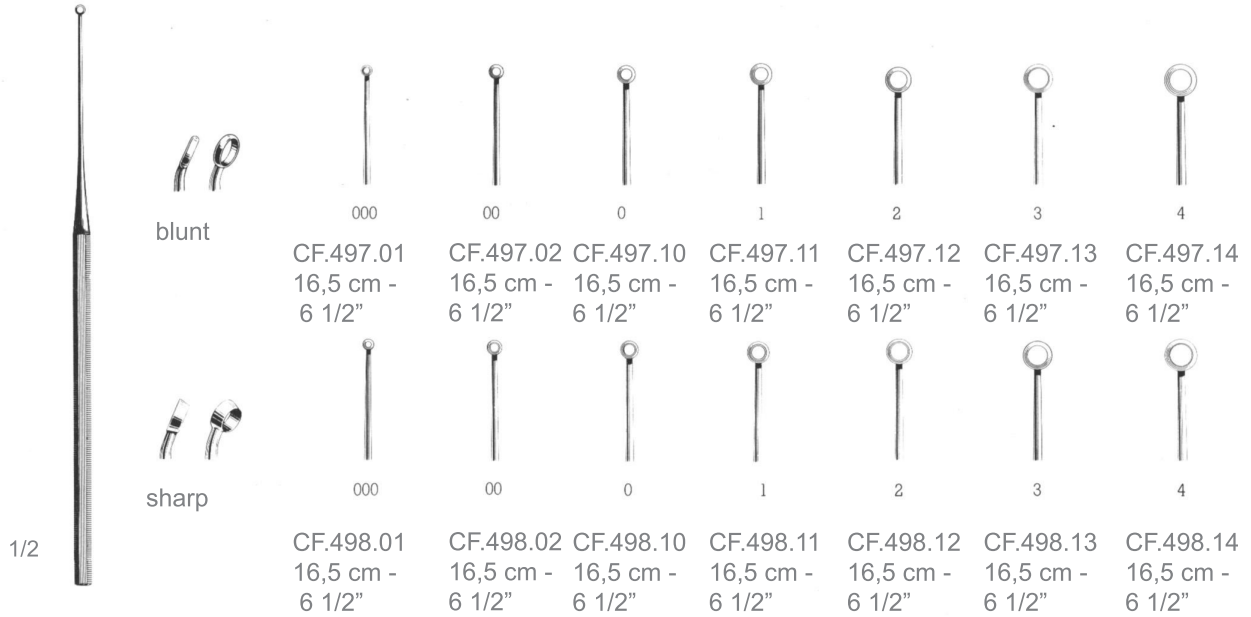

CF.497.01
CF.498.14

Buck
Curettes and Spoons

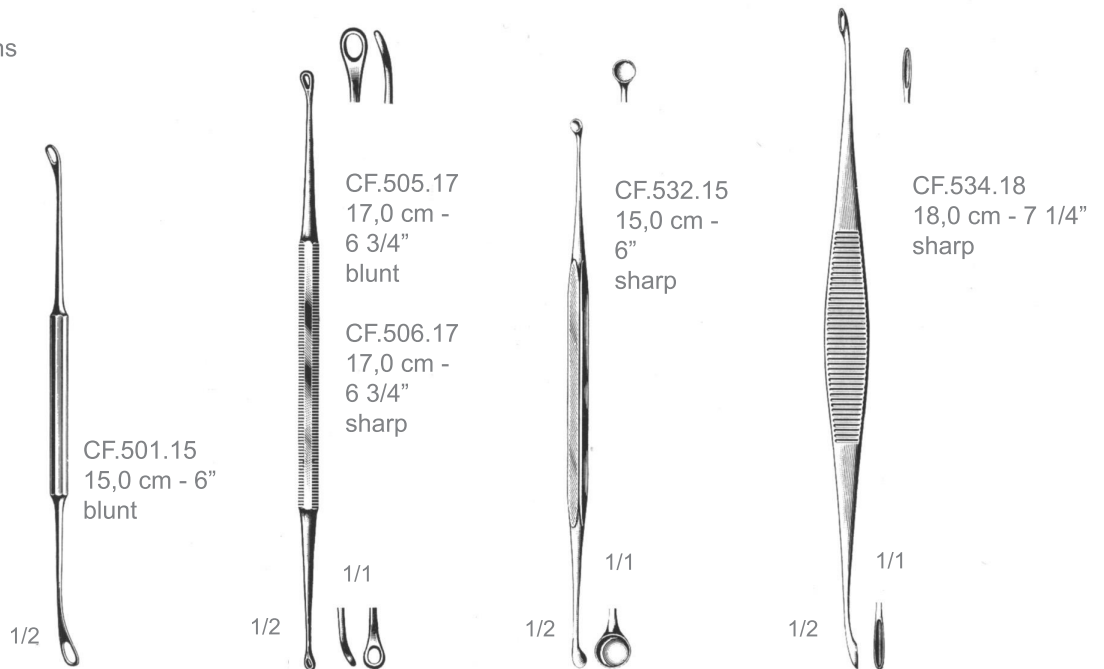

CF.501.15
Coxeter
Curettes and Spoons

CF.505.17
CF.506.17
Mod. Martin
Curettes and Spoons

CF.532.15
Jansen
Curettes and Spoons

CF.534.18
Barth
Curettes and Spoons

Loops, Foreign Body Instruments, Hooks

SCHLINGEN, FREMKÖRPERINSTRUMENTE, HAKEN
 ASAS, INSTRUMENTOS PARA CUERPOS EXTRAÑOS, GANCHOS

Kolpen

OTOLOGY
 OTOLOGIE
 OTOLÓGIA

CF

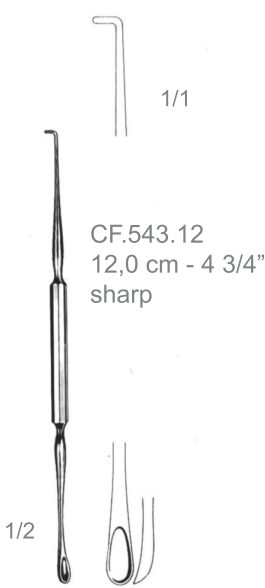

CF.543.12
 Gross
 Loops, Foreign Body
 Instruments, Hooks

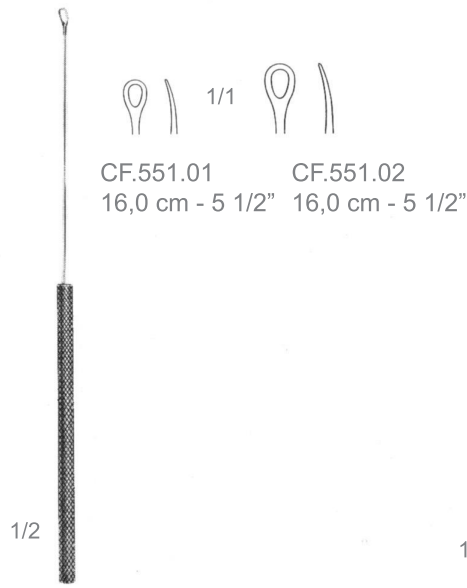

CF.551.01/02
 Loops, Foreign Body
 Instruments, Hooks

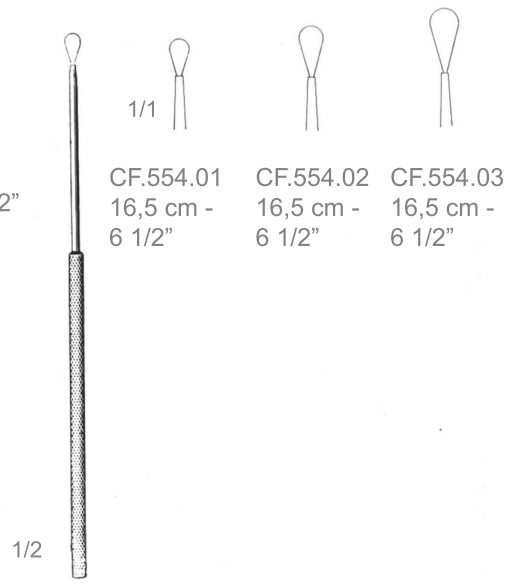

CF.554.01/03
 Billeau
 Loops, Foreign Body
 Instruments, Hooks



CF.561.16
 Moldenhauer
 Loops, Foreign Body
 Instruments, Hooks



CF.563.16
 Zaufal
 Loops, Foreign Body
 Instruments, Hooks



CF.570.16
 Hartmann
 Loops, Foreign Body
 Instruments, Hooks

Kolpen

Hooklets

OTOLOGY
OTOLOGIE
OTOLOGÍA

HÄKCHEN - GANCHITOS

CF



CF.577.01/03

Lucae
Hooklets

CF.581.16

Allport
Hooklets



CF.585.01/07

Wagener
Hooklets

CF.589.01/02

Day
Hooklets

Paracentesis Needles

PARAZENTESENADELN - AGUJAS PARA PARACENTESIS

Kolpen

OTOLOGY
OTOLOGIE
OTOLOGÍA

CF



CF.619.15
15,0 cm -
6"

CF.619.15
Buck
Paracentesis
Needles



CF.613.16
16,0 cm -
6 1/2"

CF.613.16
Poltzer
Paracentesis
Needles



CF.620.01
18,0 cm -
7 1/4"

CF.620.01
Sexton
Paracentesis
Needles

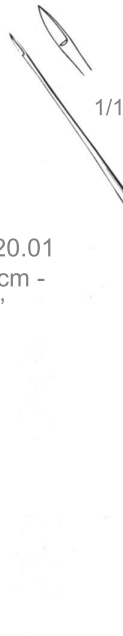

CF.621.01
17,0 cm -
6 3/4"

CF.621.01
Sexton
Paracentesis
Needles



CF.625.17
17,0 cm -
6 3/4"

CF.625.17
Gerzog-Sexton
Paracentesis
Needles



CF.630.16
16,0 cm -
6 1/2"

CF.630.16
Poltzer
Paracentesis
Needles



CF.655.16
16,5 cm -
6 1/2"

CF.655.16
Poltzer
Paracentesis
Needles



CF.655.16
16,5 cm -
6 1/2"
Needle
Horizontal

CF.657.16
Poltzer
Paracentesis
Needles

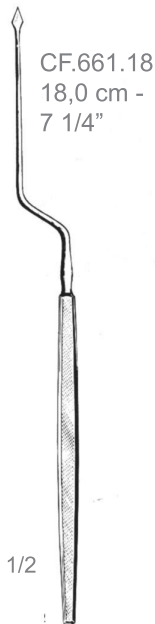

CF.661.18
18,0 cm -
7 1/4"

CF.661.18
Lucae
Paracentesis
Needles



CF.663.18
18,0 cm -
7 1/4"

CF.663.18
Lucae
Paracentesis
Needles

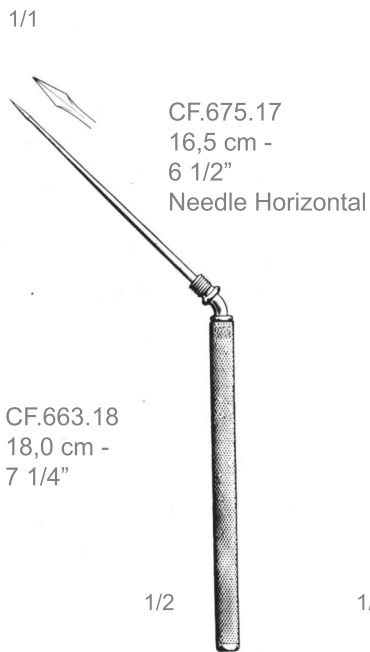

CF.675.17
16,5 cm -
6 1/2"
Needle Horizontal

CF.675.17
Poltzer
Paracentesis
Needles

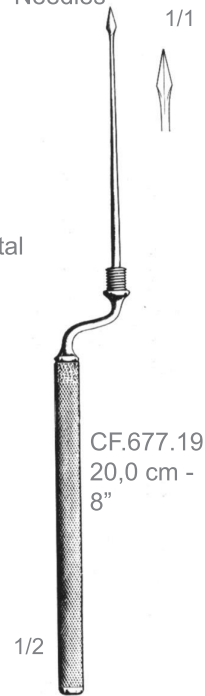

CF.677.19
20,0 cm -
8"

CF.677.19
Lucae
Paracentesis
Needles

Kolpen

OTOLOGY
OTOLOGIE
ΟΤΟΛΟΓΙΑ

Elevators, Raspatories, Curettes, etc.

ELEVATORIEN, RASPATORIEN, LÖFFEL USW.
ELEVADORES, PERIOSTÓTOMOS, CURETAS

CF

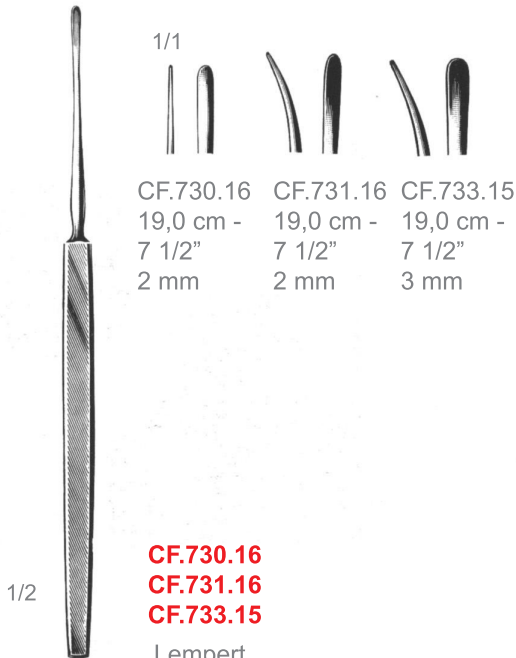

CF.730.16 19,0 cm - 7 1/2" 2 mm
CF.731.16 19,0 cm - 7 1/2" 2 mm
CF.733.15 19,0 cm - 7 1/2" 3 mm

CF.730.16
CF.731.16
CF.733.15

1/2

Lempert
Elevators,
Raspatories, Curettes

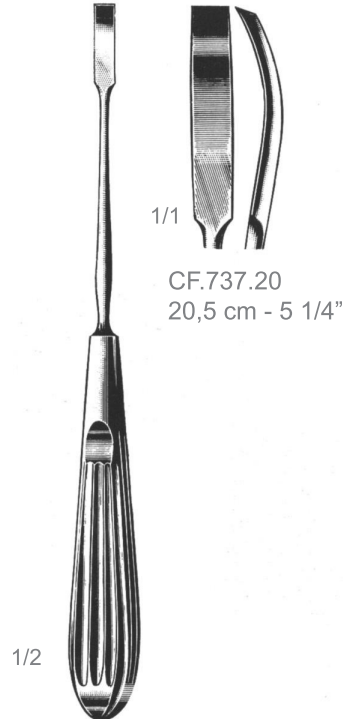

CF.737.20
20,5 cm - 5 1/4"

CF.737.20

Lempert
Elevators,
Raspatories, Curettes

1/2

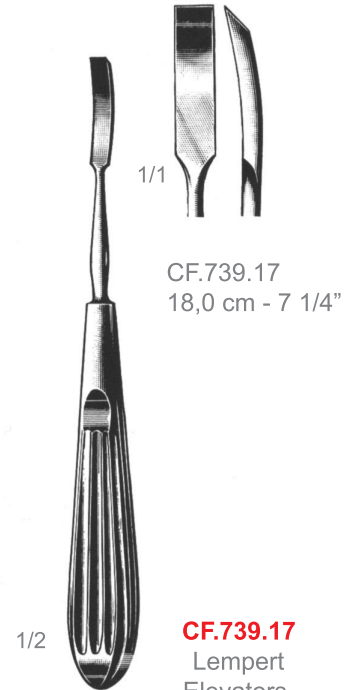

CF.739.17
18,0 cm - 7 1/4"

CF.739.17
Lempert
Elevators,

Raspatories, Curettes

1/2

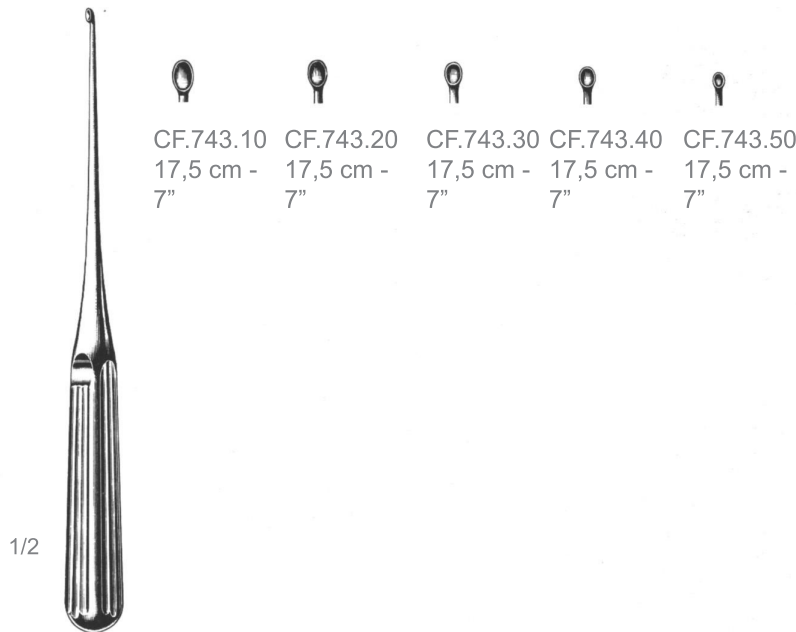

CF.743.10 17,5 cm - 7"
CF.743.20 17,5 cm - 7"
CF.743.30 17,5 cm - 7"
CF.743.40 17,5 cm - 7"
CF.743.50 17,5 cm - 7"

1/2

CF.743.10/50
Lempert
Elevators,
Raspatories, Curettes

CF.730.16 - CF.739.17
CF.743.10 - CF.743.50
CF.745.19 - CF.747.19

-Elevators
-Sharp curettes
-Wash Cannulas
(malleable silve tubes)

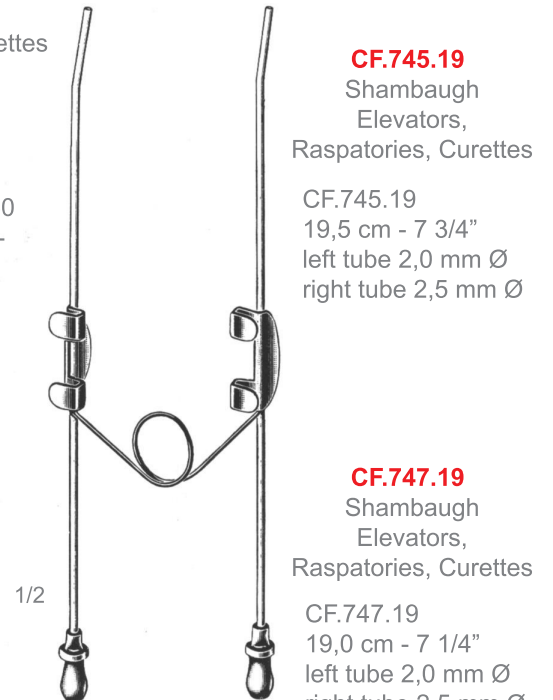

CF.745.19
Shambaugh
Elevators,
Raspatories, Curettes

CF.745.19
19,5 cm - 7 3/4"
left tube 2,0 mm Ø
right tube 2,5 mm Ø

CF.747.19
Shambaugh
Elevators,
Raspatories, Curettes

CF.747.19
19,0 cm - 7 1/4"
left tube 2,0 mm Ø
right tube 2,5 mm Ø

1/2

Powder Blowers

PULVERBLÄSER - PULVERIZADORES

Kolpen

OTOLOGY
OTOLOGIE
OTOLOGÍA

CF



- | | |
|-----------|---|
| CF.780.00 | -Kabierske powder blower complete, with three different cannulas for nose, throat and larynx. |
| CF.780.01 | -Kabierske spare bottle, 30 cc. |
| CF.780.08 | -Kabierske cannula, straight, 8 cm |
| CF.780.11 | -Kabierske cannula, straight, 11 cm |
| CF.780.13 | -Kabierske cannula, curved, 13 cm |
| CF.780.50 | -Kabierske valve rubber bulb |
| CF.785.00 | -Kabierske powder blower with a metal base |
| CF.785.85 | -Metal base only, for CF.785.00 |
| CF.786.00 | -UNIVERSAL powder blower with mobile nozzle, brown threaded bottle 30 cc and rubber bulb |
| CF.786.01 | -ditto, without rubber bulb |
| CG.851.05 | -Rubber bulb only |

CF

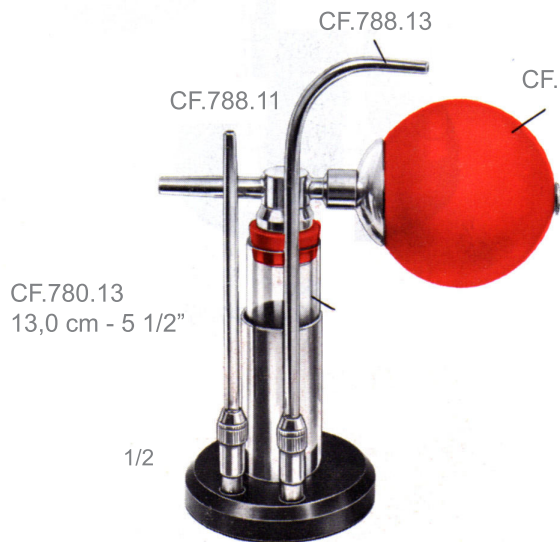

CF.780.13
13,0 cm - 5 1/2"

1/2

CF.788.00/50
Halle-Hedderich
Powder Blowers

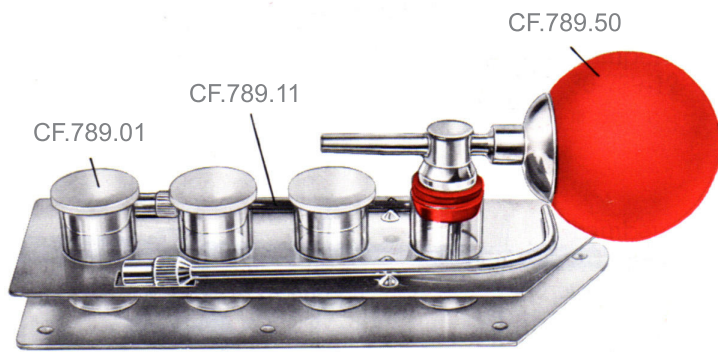

1/2

CF.789.13

- | | |
|-----------|--|
| CF.788.00 | -Halle-Hedderich powder blower with bottle, with one straight and one curved cannula, with metal base plate |
| CF.788.01 | -Halle-Hedderich spare bottle only |
| CF.788.11 | -Halle-Hedderich cannula, straight, only, 11 cm (4 3/8") |
| CF.788.13 | -Halle-Hedderich cannula, curved, only, 13 cm (5 1/2") |
| CF.788.50 | -Halle-Hedderich valve rubber bulb only |
| CF.789.00 | -Halle-Hedderich powder blower, complete with 4 bottles for different medicaments, with 1 straight and 1 curved cannula, with metal base plate |
| CF.789.01 | -Halle-Hedderich spare bottle with stopper |
| CF.789.11 | -Halle-Hedderich cannula, straight, only, 11 cm (4 3/8") |
| CF.789.13 | -Halle-Hedderich cannula, curved, only, 13 cm (5 1/2") |
| CF.789.50 | -Halle-Hedderich valve rubber bulb, only |



CF.792.50



CF.792.02
Politzer Aseptic
Politzer Air Bag

Politzer

- | | |
|-----------|---|
| CF.792.00 | -Politzer air bag, equipped with three nasal tips No. CF.792.15, CF.792.17, CF.792.22 |
| CF.792.01 | -some as CF.792.00, but with an additional ear tip No. CF.792.04 |
| CF.792.02 | -Politzer Aseptic, with 3 nasal and 1 ear tip. The complete and clearly disposed Politzer set in transparent dust cover |
| CF.792.03 | -Politzer Connecting nozzle |
| CF.792.04 | -Politzer Ear tip 4 mm Ø |
| CF.792.15 | -Politzer Nasal tip 15 mm Ø |
| CF.792.17 | -Politzer Nasal tip 17 mm Ø |
| CF.792.22 | -Politzer Nasal tip 22 mm Ø |
| CF.792.50 | -Politzer Rubber bulb with metal base plate |

Kolpen

Ear Syringes

OTOLOGY
OTOLOGIE
OTOLOGÍA

OHRSPRITZEN - JERINGAS PARA LOS OÍDOS

CF

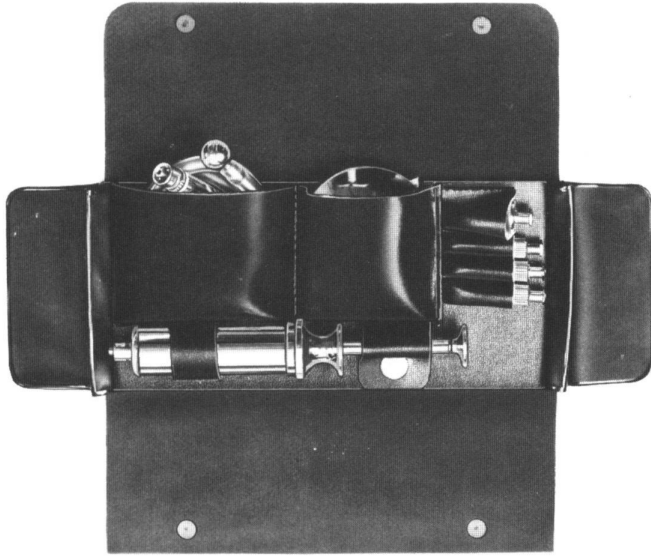

CF.794.00
Ear Syringe,
complete, self-filling

CF.794.00/09
Ear Syringes



CF.794.03
Ear Syringes

1/2

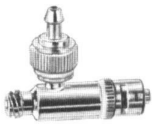

CF.794.02
Valve
connection



CF.794.04
Suction end

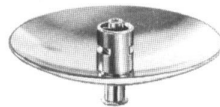

CF.794.05
Protecting
disk

1/2



CF.794.06
Cannulae



CF.794.07



CF.794.08



CF.794.09



CF.795.00 50 ml
CF.795.02 75 ml
CF.795.04 100 ml

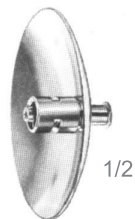

1/2

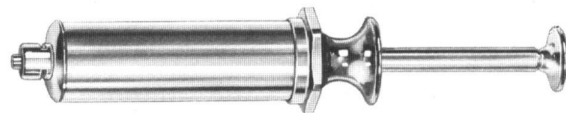

CF.795.00/04
Ear Syringes

Ear Syringe, complete