

Kolpen

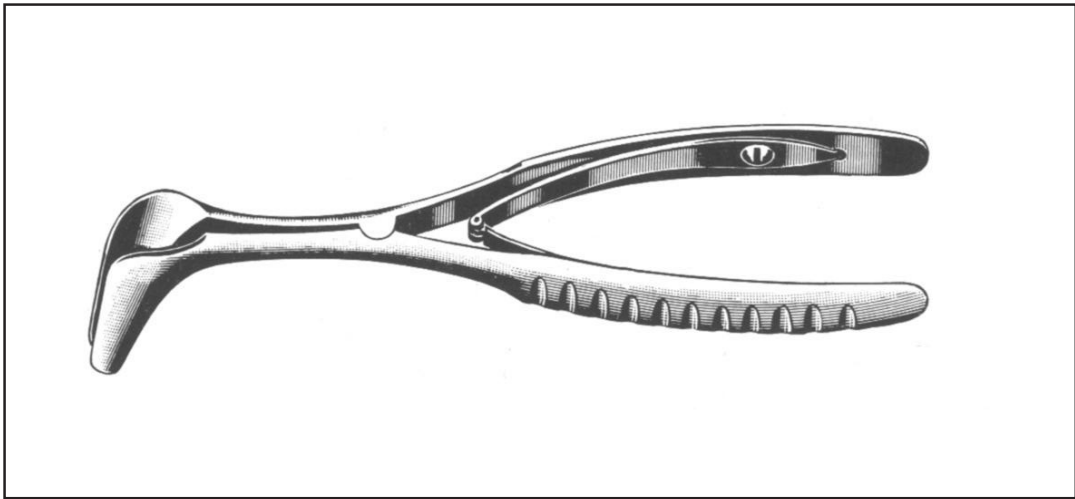

CG



CF.817.01

CF.817.02

CF.817.03



1/1

CF.823.01

CF.823.02

CF.823.03



1/2

CF.817.01/03

Goldsmith (Thudichum)
Nasal Specula



1/2

CF.823.01/03

Voltolini
Nasal Specula



1/1

CF.841.14
14,0 cm - 5 1/2"

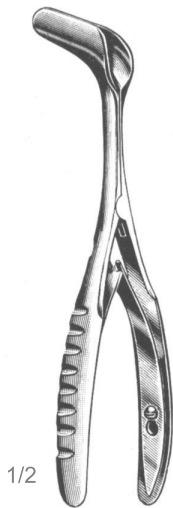

1/2

CF.841.14

Schwarz
Nasal Specula

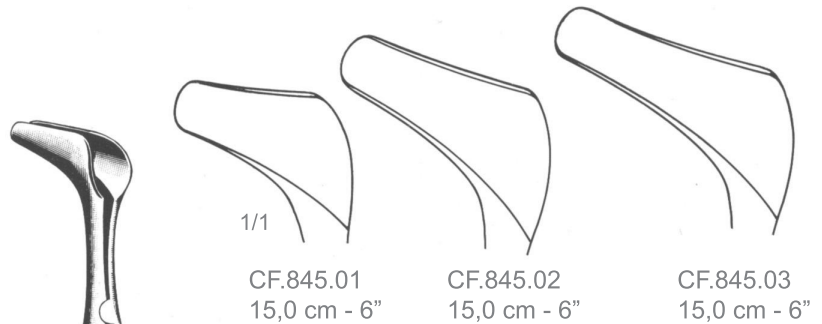

1/1

CF.845.01
15,0 cm - 6"

CF.845.02
15,0 cm - 6"

CF.845.03
15,0 cm - 6"



1/2

CF.845.01/03

Hartmann-Halle
Nasal Specula



CF.848.13
13,0 cm - 5"
Pediatrics

CF.848.13
Mod. Martin
Nasal Specula



CF.849.13
13,0 cm - 5"

CF.849.13
Mod. Martin
Nasal Specula



CF.852.13
13,5 cm - 5 1/4"

CF.852.13
Tieck-Halle
Nasal Specula



CF.853.13
13,5 cm - 5 1/4"

CF.853.13
Tieck-Halle
Nasal Specula



CF.856.01/04
Killian
Nasal Specula

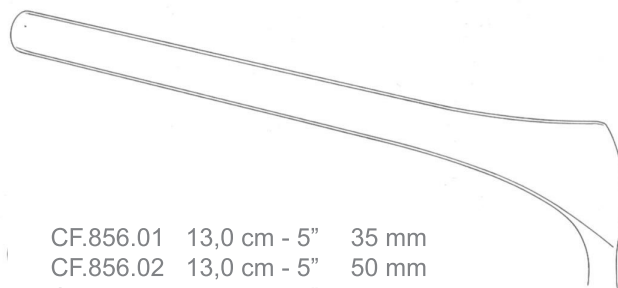

CF.856.01 13,0 cm - 5" 35 mm
CF.856.02 13,0 cm - 5" 50 mm
CF.856.03 13,0 cm - 5" 75 mm
CF.856.04 13,0 cm - 5" 90 mm

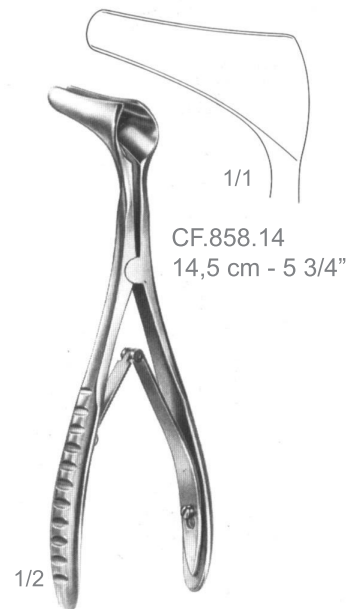

CF.858.14
14,5 cm - 5 3/4"

CF.858.14
Mod. Wien
Nasal Specula

CF
CG

RHINOLOGY
RHINOLOGIE
RINOLOGÍA

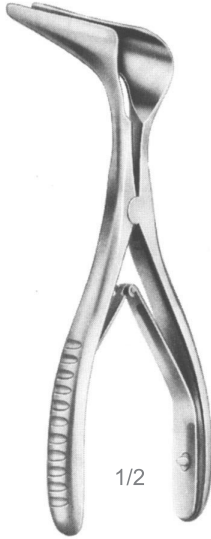

CF.859.35/90
Cottle
Nasal Specula

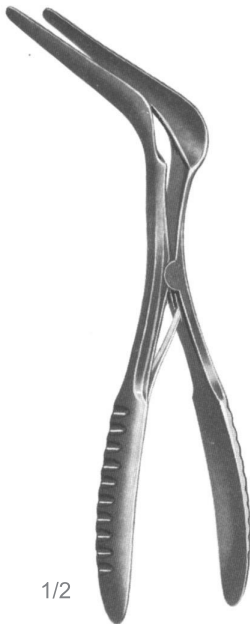
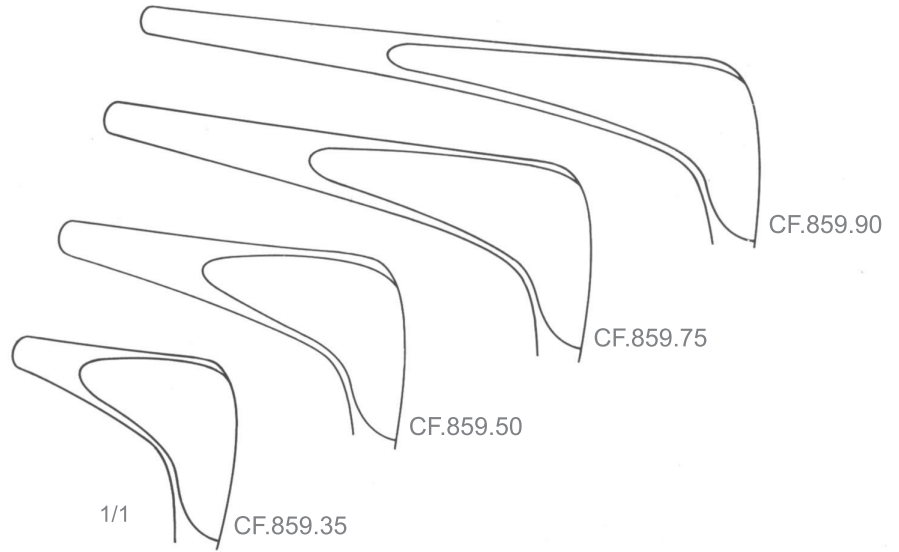

CF.861.45/75
Cottle
Nasal Specula

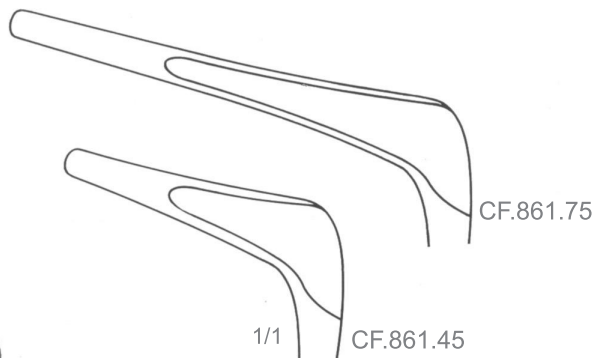

CF.861.45/75
14,0 cm - 5 1/2"
Dull black chromiun plated



CF.862.19
19,0 cm - 7 1/2"

CF.862.19
Yankauer
Nasal Specula

Nasal Snares

POLYPENSCHNÜRER - POLIPÓTOMOS

Kolpen

RHINOLOGY
RHINOLOGIE
RINOLÓGIA

CF
CG

CF.885.26
26,0 cm - 10 1/4"

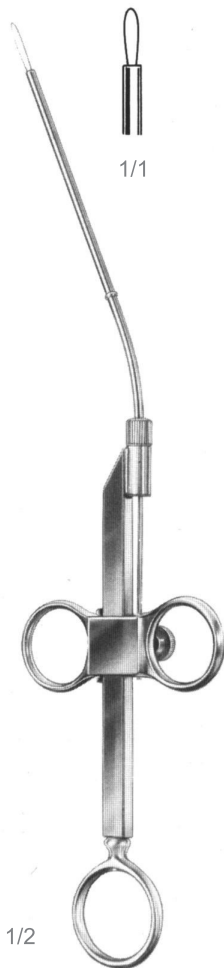

CF.885.26
Krause
Nasal Snares

CF.887.26
26,0 cm - 10 1/4"

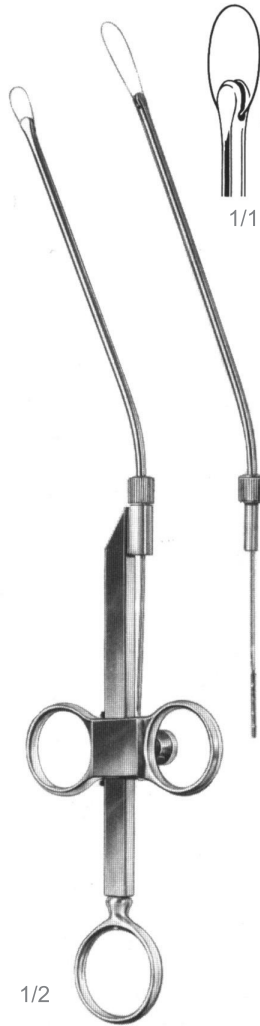

CF.887.26
Krause-Voss
Nasal Snares

CF.898.30/40
10 m / 33 ft.

CF.898.30 0,3 mm Ø
CF.898.40 0,4 mm Ø



CF.898.30/40
Nasal Snares

CF.899.12 0,3 mm Ø



CF.899.12
Nasal Snares

CG



CG.101.15
15,0 cm - 6"

CG.101.15
Troeltsch
Dressing and
Tampon Forceps



CG.105.18
18,0 cm - 7"

CG.105.18
Troeltsch
Dressing and
Tampon Forceps



CG.115.20
20,0 cm - 8"

CG.115.20
Gruenwald (Jansen)
Dressing and Tampon
Forceps

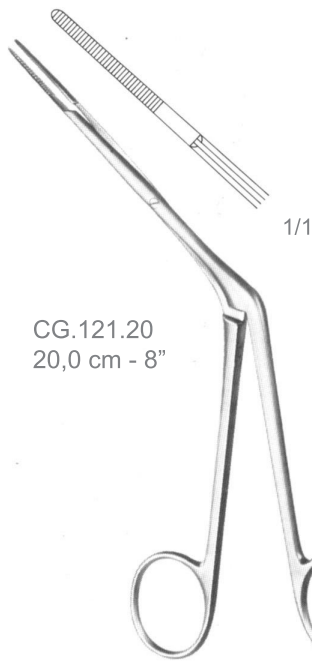

CG.121.20
20,0 cm - 8"

CG.121.20
Westmacott
Dressing and
Tampon Forceps



CG.129.20
20,0 cm - 8"

CG.129.20
Lubet-Barbon
Dressing and
Tampon Forceps



CG.141.16
16,0 cm - 6 1/4"

CG.141.16
Hartmann
Dressing and
Tampon Forceps



CG.143.18
18,0 cm - 7"

CG.143.18
Heymann-Knight
Dressing and
Tampon Forceps

Nasal Polypus and Septum Compression Forceps

POLYPENZANGEN, SEPTUMZANGE -
PINZAS PARA PÓLIPOS, PINZA PARA EL TABIQUE NASAL

Kolpen

RHINOLOGY
RHINOLOGIE
RINOLOGÍA

CG

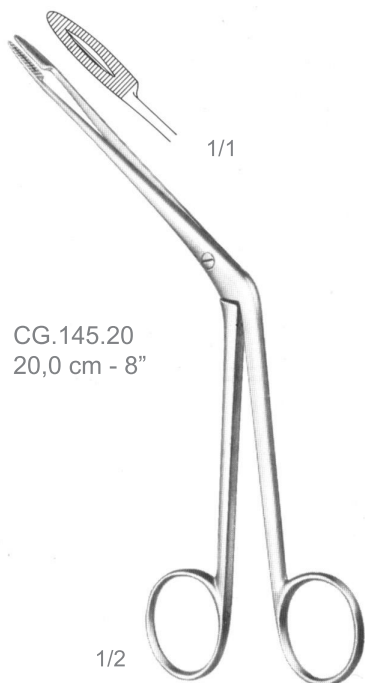

CG.145.20
20,0 cm - 8"

CG.145.20
Hartmann
Nasal Polypus and
Septum Compression
Forceps



CG.151.18
18,0 cm - 7"

CG.151.18
Littauer
Nasal Polypus and
Septum Compression
Forceps

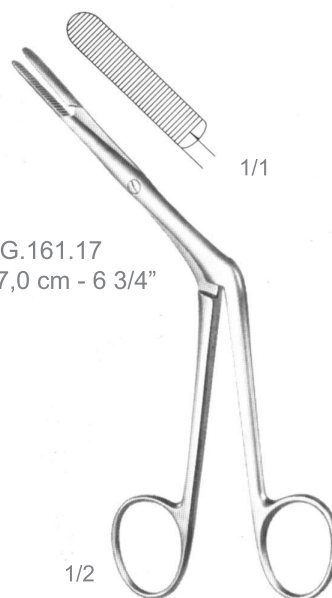

CG.161.17
17,0 cm - 6 3/4"

CG.161.17
Killian
Nasal Polypus and
Septum Compression
Forceps



CG.201.01
18,0 cm - 7"



CG.201.02
18,0 cm - 7"



CG.201.03
18,0 cm - 7"



CG.201.01/03
Heymann
Nasal Polypus and
Septum Compression
Forceps



CG.207.18
18,0 cm - 7"



CG.207.18
Knight
Nasal Polypus and
Septum Compression
Forceps

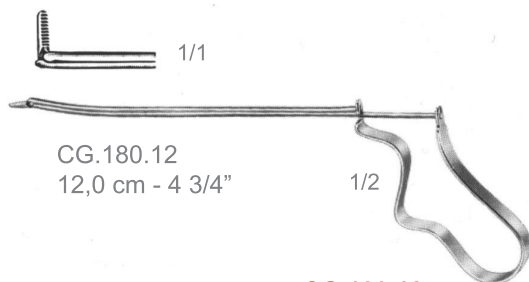

CG.180.12
12,0 cm - 4 3/4"

CG.180.12
Quire
Nasal Polypus and
Septum Compression
Forceps



CG.213.18
18,0 cm - 7"

CG.213.18
Craig
Nasal Polypus and
Septum Compression
Forceps



CG.215.01
18,0 cm - 7"

CG.215.02
18,0 cm - 7"

CG.215.01/02
Nasal Polypus and
Septum Compression
Forceps

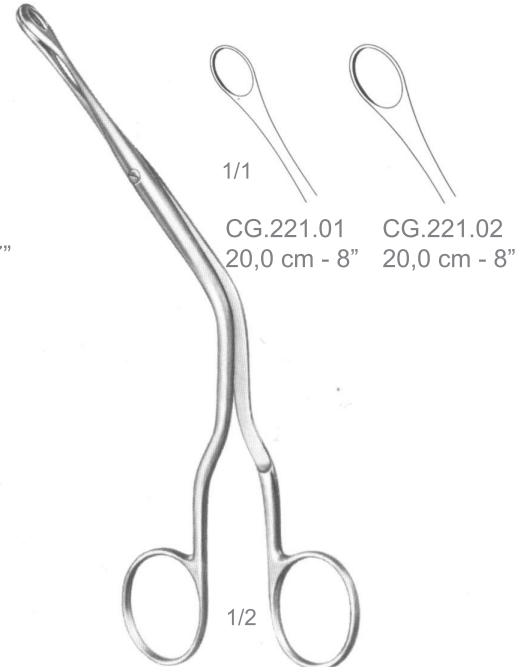

CG.221.01
20,0 cm - 8"

CG.221.02
20,0 cm - 8"

CG.221.01/02
Luc
Nasal Polypus and
Septum Compression
Forceps

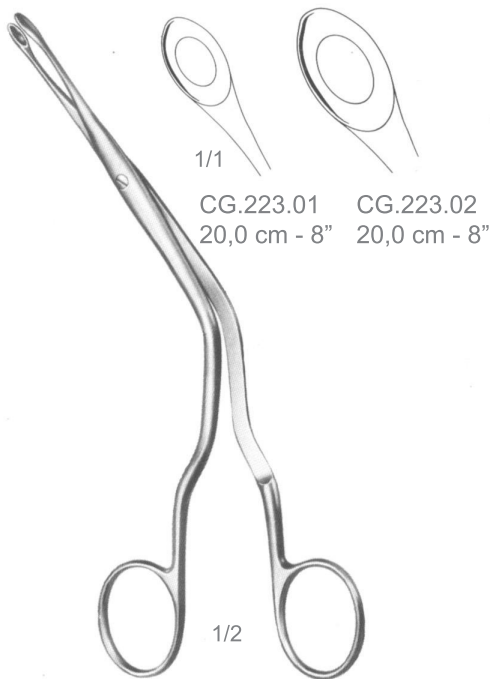

CG.223.01
20,0 cm - 8"

CG.223.02
20,0 cm - 8"

CG.223.01/02
Luc
Nasal Polypus and
Septum Compression
Forceps

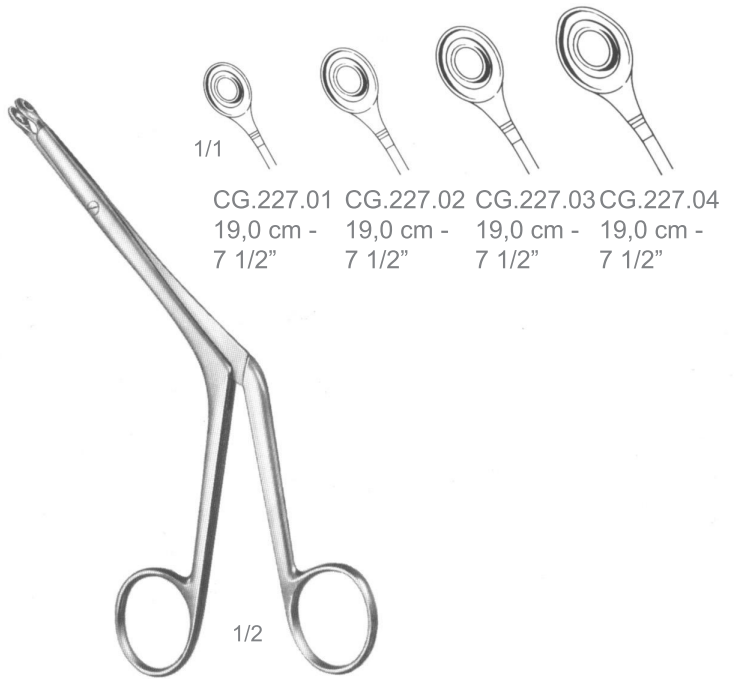

CG.227.01
19,0 cm -
7 1/2"

CG.227.02
19,0 cm -
7 1/2"

CG.227.03
19,0 cm -
7 1/2"

CG.227.04
19,0 cm -
7 1/2"

CG.227.01/04
Bruenings
Nasal Polypus and
Septum Compression
Forceps

Nasal Cutting Forceps

SCHARFE NASENZANGEN - PINZAS CORTANTES PARA LA NARIZ

Kolpen

RHINOLOGY
RHINOLOGIE
RINOLOGÍA

CG

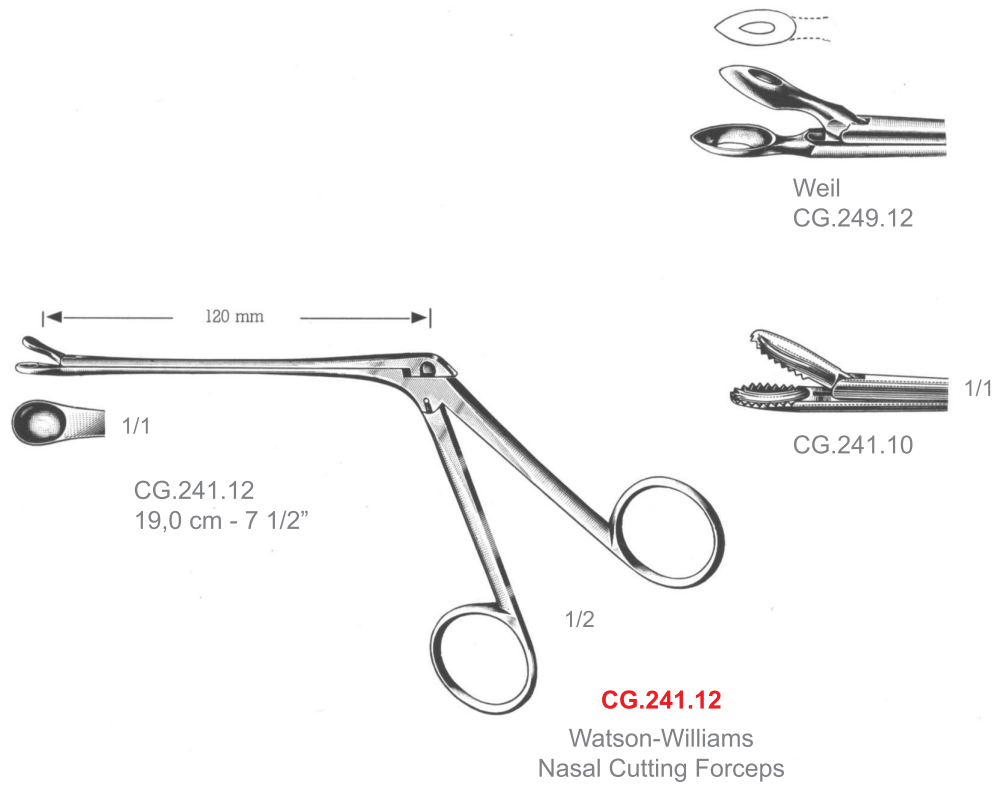
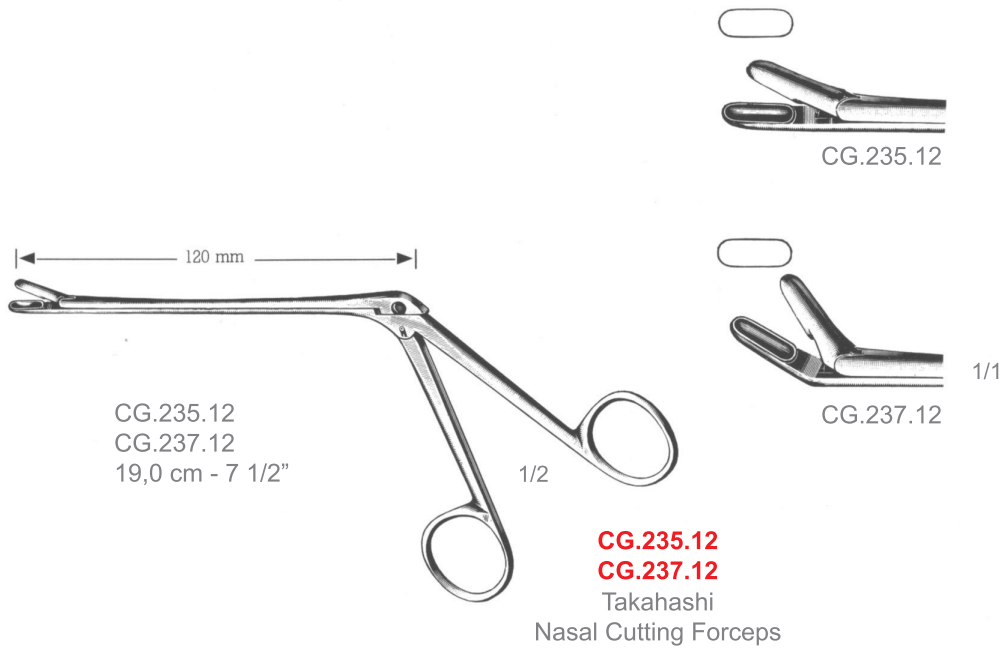

CG



CG.255.01/05
CG.257.01/05
19,0 cm - 7 1/2"

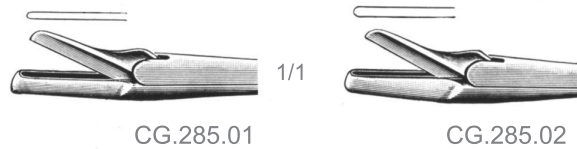
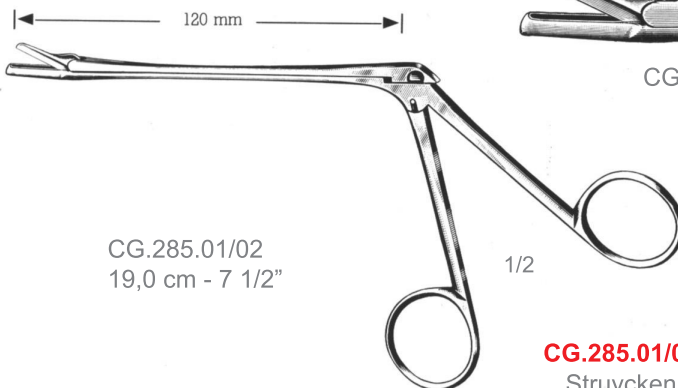
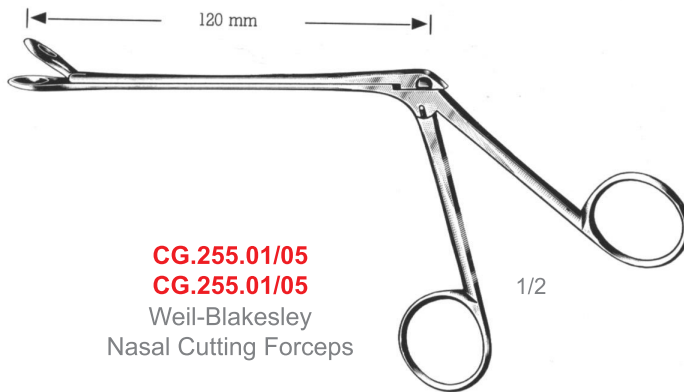





Nasal Cutting Forceps

SCHARFE NASENZANGEN - PINZAS CORTANTES PARA LA NARIZ

Kolpen

RHINOLOGY
RHINOLOGIE
RINOLOGÍA

CG

-  CG.287.01
2,2 mm
-  CG.287.02
2,6 mm
-  CG.287.03
3,0 mm
-  CG.287.04
3,4 mm

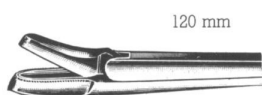

CG.287.01/04
Nasal Cutting Forceps

CG.295.01/03
19,0 cm - 7 1/2"

-  CG.295.01
-  CG.295.01
-  CG.295.01



CG.295.01/03
Myles
Nasal Cutting Forceps

CG.301.12
19,0 cm - 7 1/2"

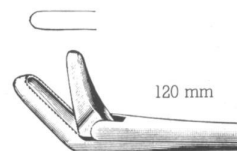

CG.301.12
Hajek
Nasal Cutting Forceps

CG.309.01/04
19,0 cm - 7 1/2"

-  CG.309.01
5 mm
-  CG.309.02
7 mm
-  CG.309.03
9 mm
-  CG.309.04
11 mm

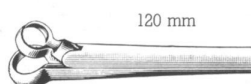

CG.309.01/04
Hartmann
Nasal Cutting Forceps

CG.313.12
19,0 cm - 7 1/2"

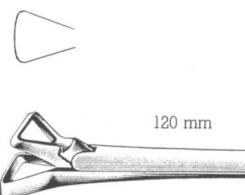

CG.313.12
Schmeden
Nasal Cutting Forceps

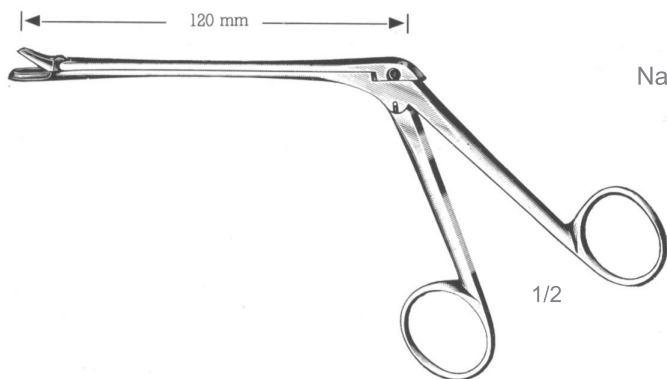

CG.321.19
19,0 cm - 7 1/2"

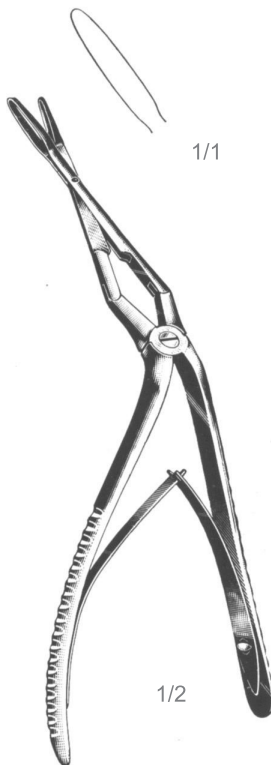

CG.321.19
Jansen-Struycken
Nasal Cutting and
Punch Forceps

CG.323.19
19,0 cm - 7 1/2"



CG.323.19
Middleton-Jansen
Nasal Cutting and
Punch Forceps

CG.327.19
19,0 cm - 7 1/2"

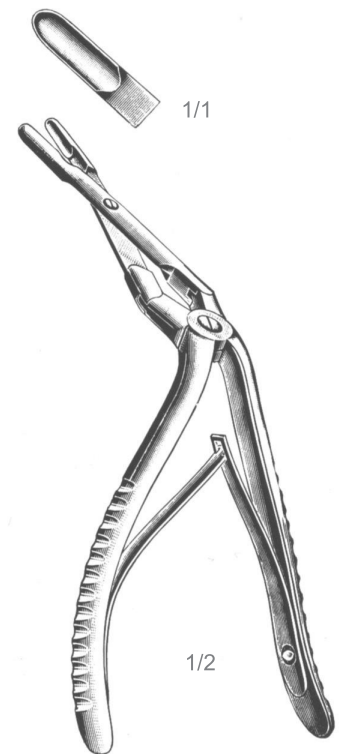

CG.327.19
Middleton-Jansen
Nasal Cutting and
Punch Forceps

CG.331.20
20,0 cm - 8"



CG.331.20
Caplan
Septum Scissors

CG.333.21
21,0 cm - 8 1/2"

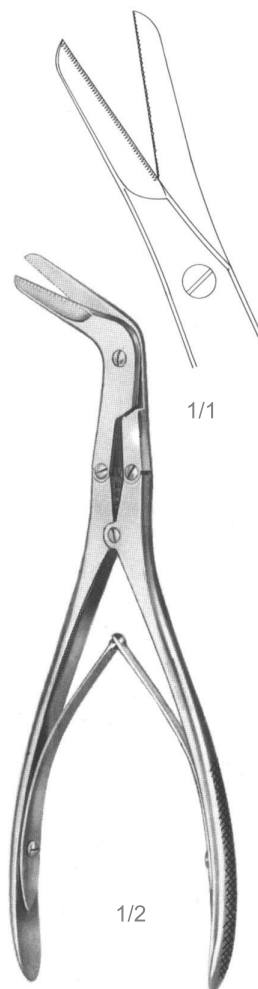

CG.333.21
Killian
Septum Scissors

CG.335.21
21,0 cm - 8 1/2"

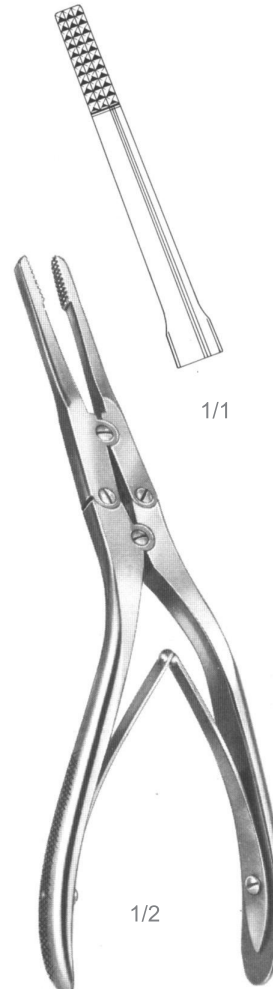

CG.335.21
Rubin
Septum Scissors



CG.331.20 -Septumscissors serrated
CG.333.21 -Septumscissors serrated
CG.335.21 -Septum morselizer

Kolpen

RHINOLOGY
RHINOLOGIE
RINOLOGÍA

Sphenoid Punches, Antrum Punch Forceps

KEILBEINSTANZEN, KIEFERHÖHLENSTANZEN - PINZAS CORTANTES PARA SEND ESFENOIDAL Y MAXILAR

CG

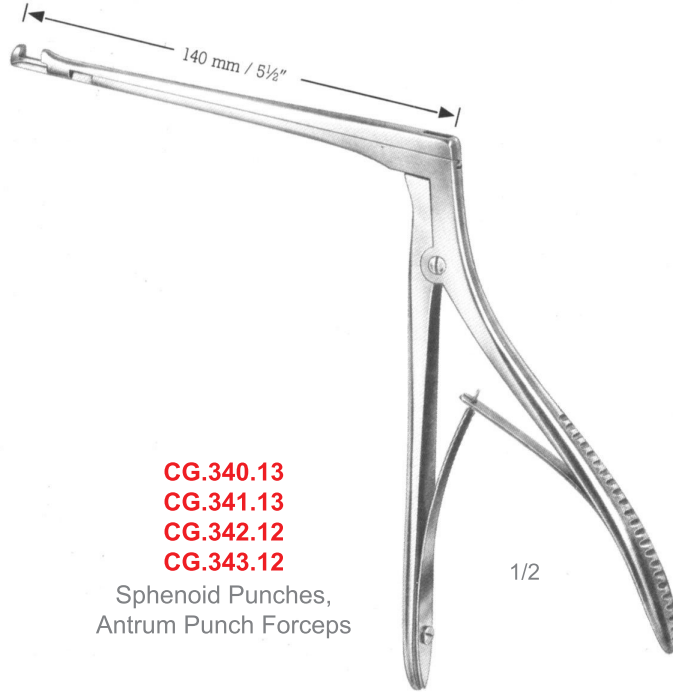

CG.340.13
CG.341.13
CG.342.12
CG.343.12

Sphenoid Punches,
Antrum Punch Forceps

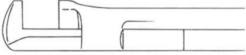
4 × 4 mm   Hajek
CG.340.13

4 × 4 mm   Hajek
CG.341.13

3,5 × 3,5 mm   Hajek-Kofler
CG.342.12

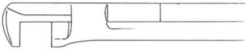

3,5 × 3,5 mm   Hajek-Kofler
CG.343.12

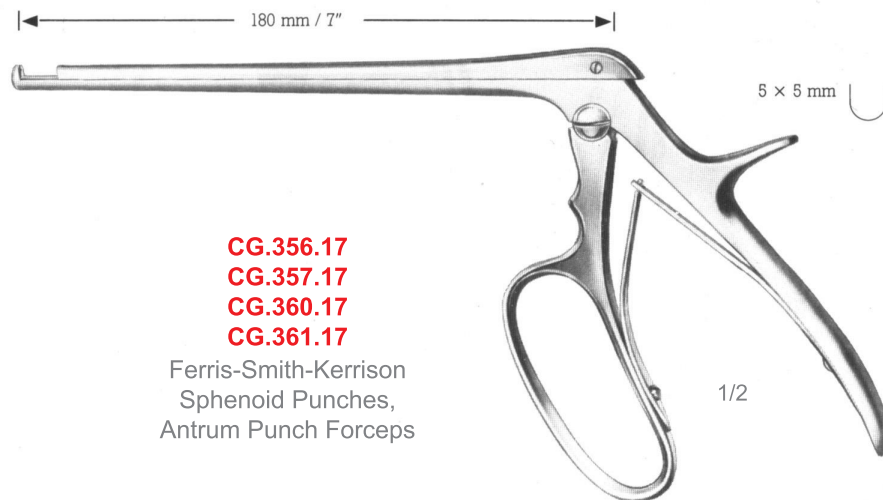
1/1





CG.356.17
CG.357.17
CG.360.17
CG.361.17

Ferris-Smith-Kerrison
Sphenoid Punches,
Antrum Punch Forceps

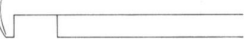
3 × 5 mm   CG.356.17

3 × 5 mm   CG.357.17

5 × 5 mm   CG.360.17

5 × 5 mm   CG.361.17

1/1

1/2

Sphenoid Punches and Rongeur Forceps

KEILBEINSTANZEN, MEIBELZANGEN - PINZAS CORTANTES PARA SENO ESFENCODAL, PINZAS-GUBIAS

Kolpen

RHINOLOGY
RHINOLOGIE
RINOLOGÍA

CG

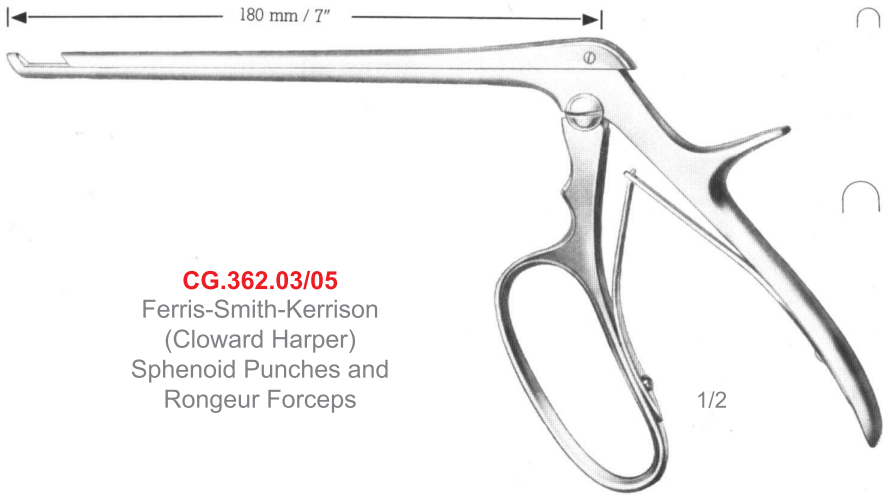

CG.362.03/05
Ferris-Smith-Kerrison
(Cloward Harper)
Sphenoid Punches and
Rongeur Forceps

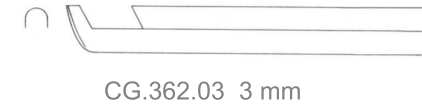

CG.362.03 3 mm



CG.362.05 5 mm 1/1

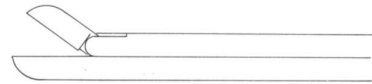

- CG.365.02 2 x 10 mm
- CG.365.03 3 x 10 mm straight
- CG.365.04 4 x 10 mm

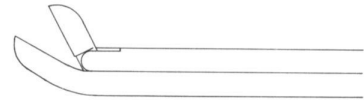

- CG.364.02 2 x 10 mm
- CG.364.03 3 x 10 mm
- CG.364.04 4 x 10 mm curved up
- CG.364.05 5 x 10 mm
- CG.364.06 6 x 10 mm

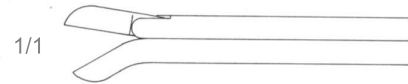

- CG.367.02 2 x 10 mm
- CG.367.03 3 x 10 mm curved down
- CG.367.04 4 x 10 mm

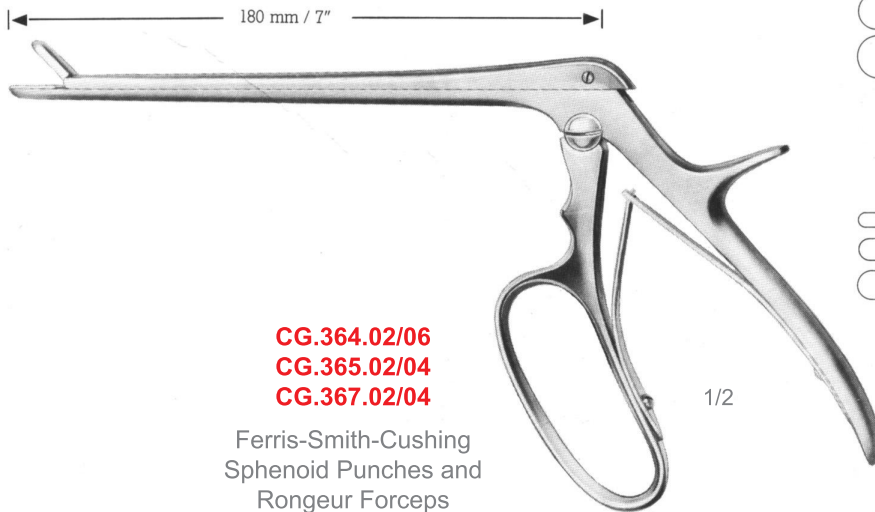

CG.364.02/06
CG.365.02/04
CG.367.02/04
Ferris-Smith-Cushing
Sphenoid Punches and
Rongeur Forceps

CG.383.20
20,0 cm - 8"

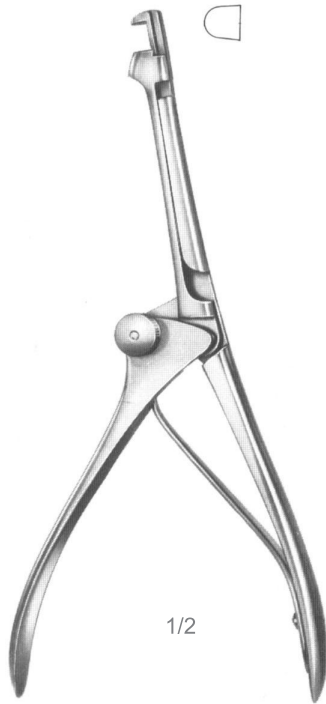

CG.383.20
Hajek-Claus
Sphenoid Punches,
Antrum Punch Forceps

4 × 4 mm  CG.389.01
4 mm
5 × 5 mm  CG.389.02
5 mm
6 × 6 mm  CG.389.03
6 mm
1/1



CG.389.01/03
Kerrison
Sphenoid Punches,
Antrum Punch Forceps

CG.389.01/03
20,0 cm - 8"

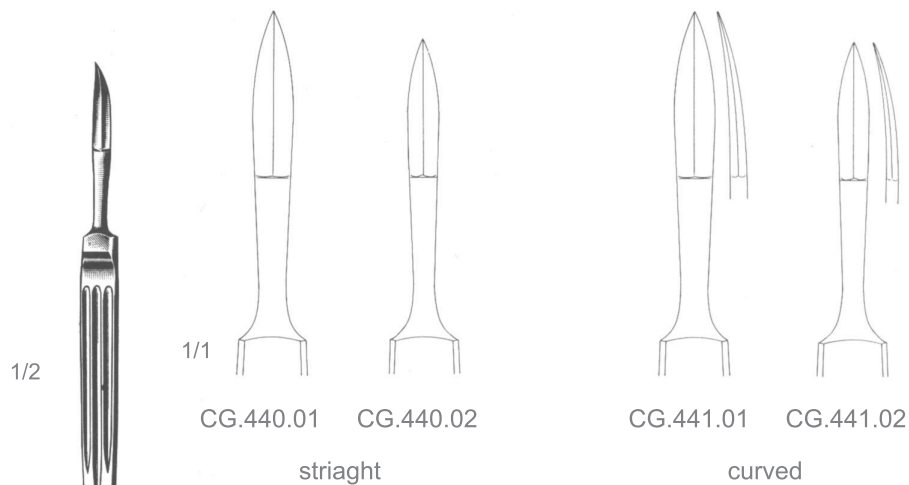

CG.440.01/02
CG.441.01/02

Joseph
Rhinoplastic and
Nasal knives

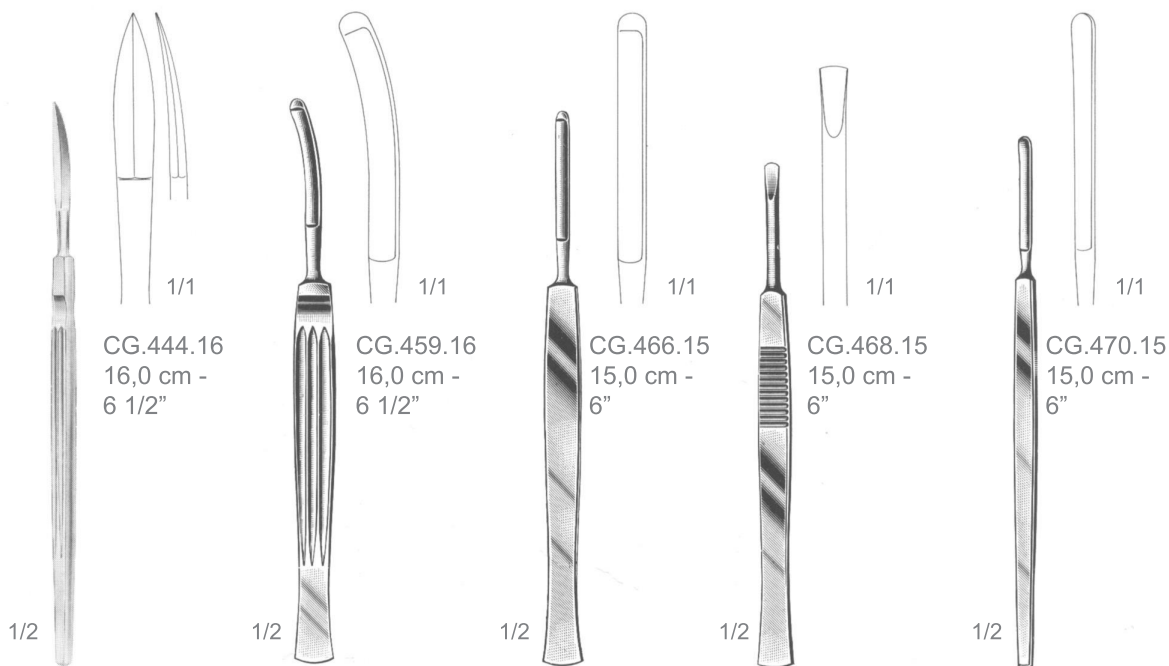

CG.444.16
Fomon
Rhinoplastic and
Nasal knives

CG.459.16
Converse
Rhinoplastic and
Nasal knives

CG.466.15
Joseph
Rhinoplastic and
Nasal knives

CG.468.15
Cottle
Rhinoplastic and
Nasal knives

CG.470.15
Cottle
Rhinoplastic and
Nasal knives

CG



Septum Elevators

SEPTUM-ELEVATORIEN - ELEVADORES Y ESPÁTULAS PARA EL TABIQUE NASAL

Kolpen

RHINOLOGY
RHINOLOGIE
RINOLOGÍA

CG

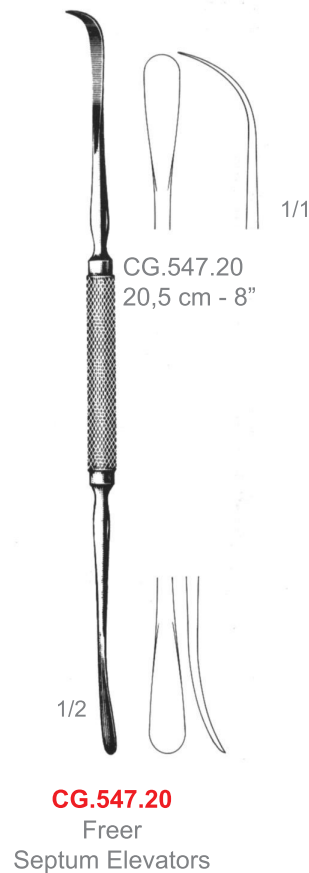
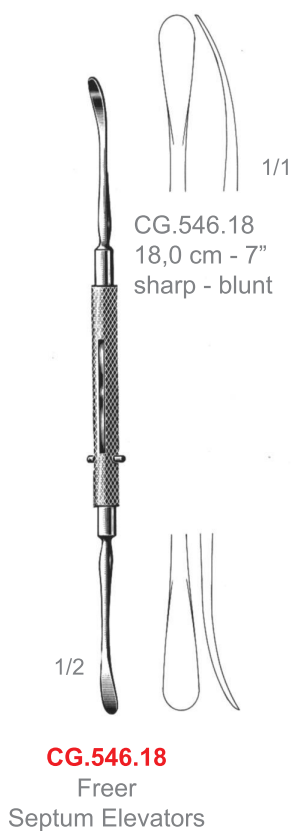
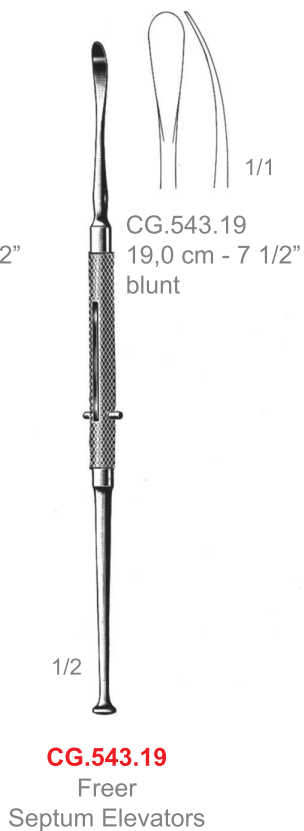
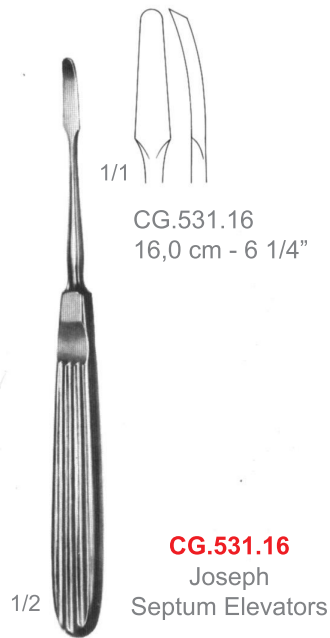
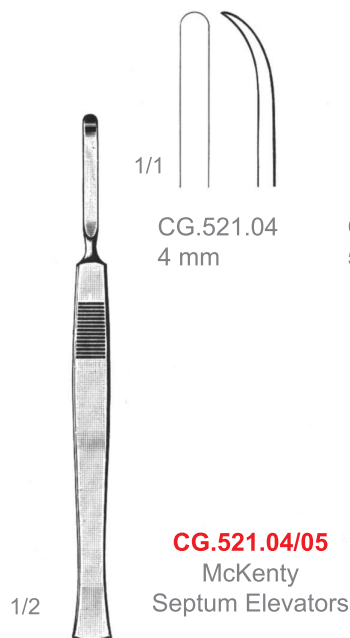

CG.549.22
22,0 cm - 8 3/4"

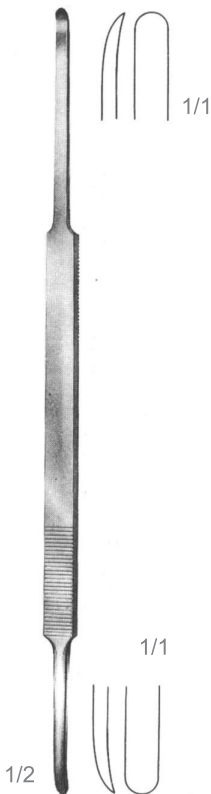

CG.549.22
McKenty
Septum and
Periosteal
Elevators

CG.559.23
23,0 cm - 9"

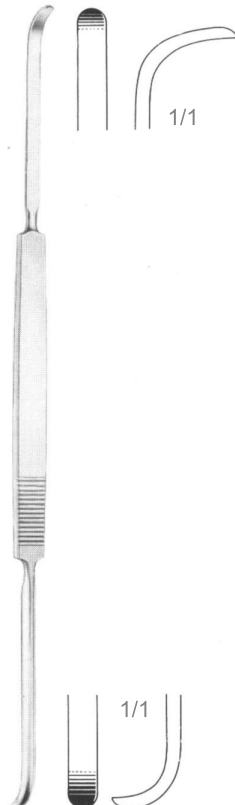

CG.559.23
Cottle
Septum and
Periosteal
Elevators

CG.560.18
18,0 cm - 7"



CG.560.18
Killian
Septum and
Periosteal
Elevators

CG.562.22
22,0 cm - 8 3/4"



CG.562.22
Killian
Septum and
Periosteal
Elevators

CG.566.21
21,0 cm -
8 1/2"

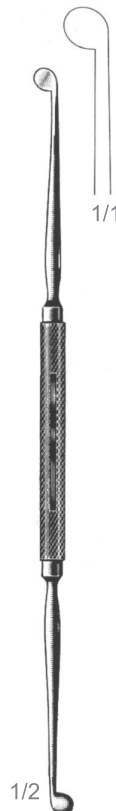

CG.566.21
Pierce
Septum and
Periosteal
Elevators

CG.568.21
21,0 cm -
8 1/2"

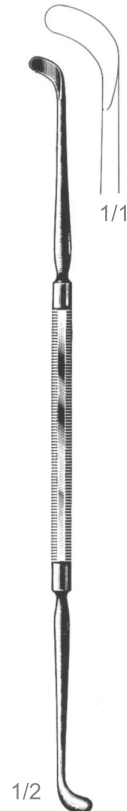

CG.568.21
Pennington
Septum and
Periosteal
Elevators

CG.572.19
19,0 cm - 7"

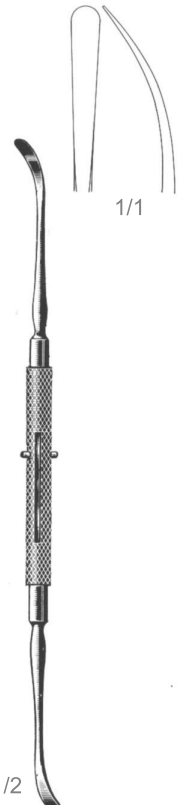

CG.572.19
Roger
Septum and
Periosteal
Elevators

Septum and Periosteal Elevators

SEPTUM- UND PERIOST-ELEVATORIEN - ELEVADORES PARA EL TABIQUE NASAL Y PARA EL PERIOSTIO

Kolpen

RHINOLOGY
RHINOLOGIE
RINOLOGÍA

CG

CG.574.21
21,0 cm - 8 1/2"



CG.574.21
Carter
Septum and
Periosteal
Elevators

CG.579.22
22,0 cm - 8 3/4"



CG.579.22
Joseph-Masing
Septum and
Periosteal
Elevators

CG.581.22
22,0 cm - 8 3/4"

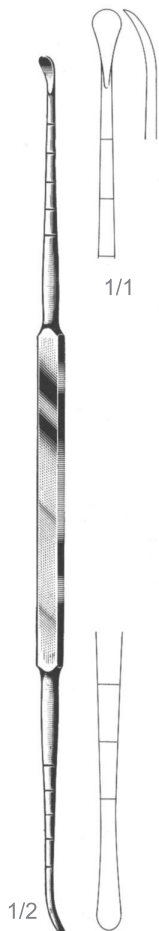

CG.581.22
Cottle
Septum and
Periosteal
Elevators

CG.583.21
21,0 cm - 8 1/2"



CG.583.21
Masing
Septum and
Periosteal
Elevators

CG.584.21
21,0 cm - 8 1/2"

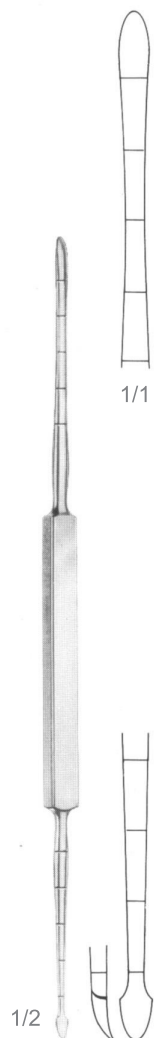

CG.584.21
Cottle
Septum and
Periosteal
Elevators

CG.585.16
16,0 cm - 6 1/4"

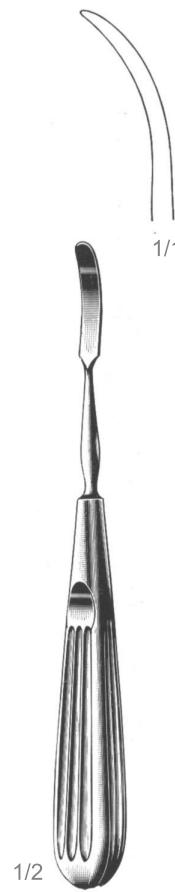

CG.585.16
Joseph
Septum and
Periosteal
Elevators

Kolpen

RHINOLOGY
RHINOLOGIE
RINOLOGÍA

Rhinoplastic Instruments etc

INSTRUMENTE ZUR NASENPLASTIK USW - INSTRUMENTOS PARA LA PLÁSTICA NASAL ETC.

CG

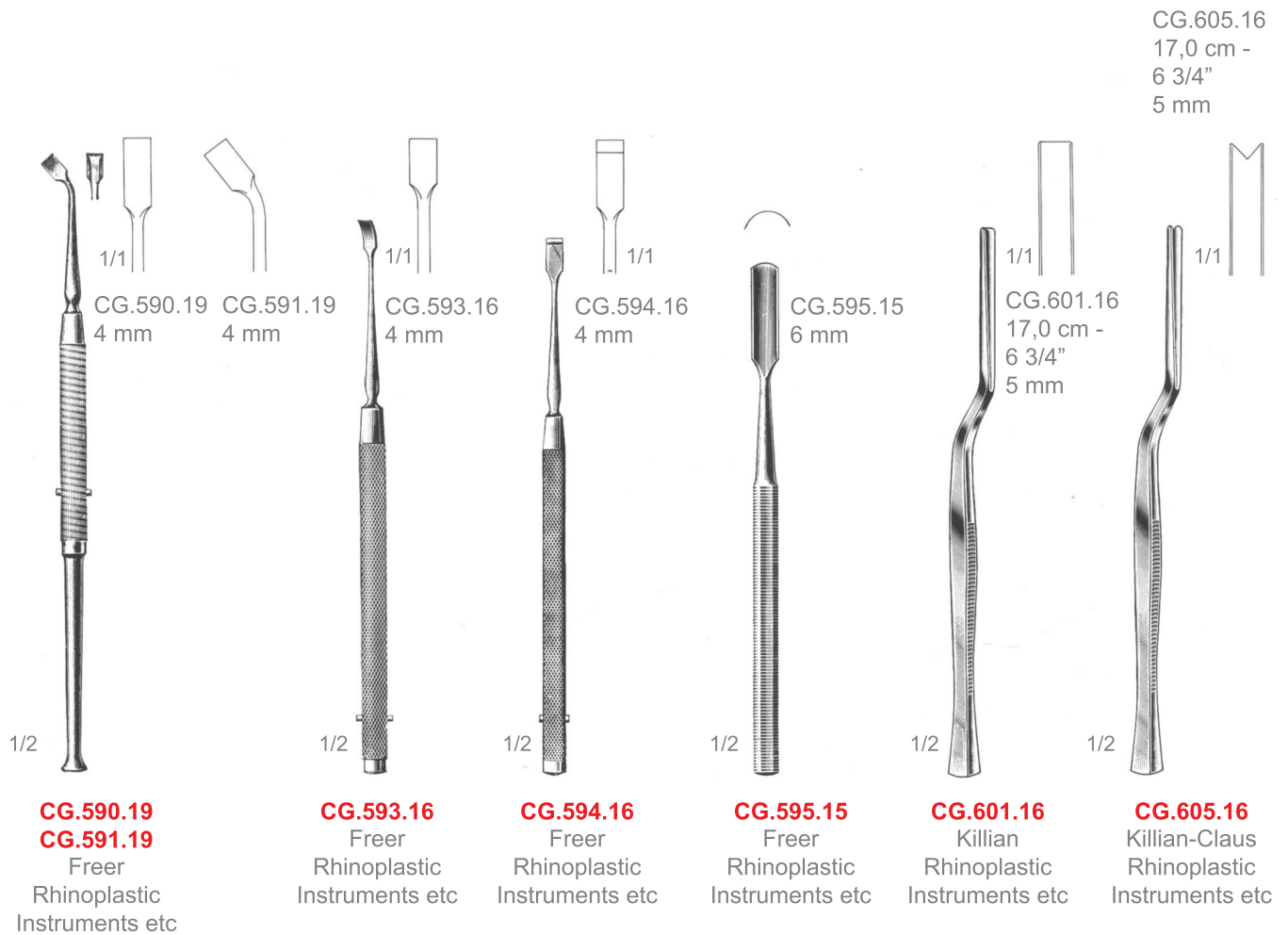

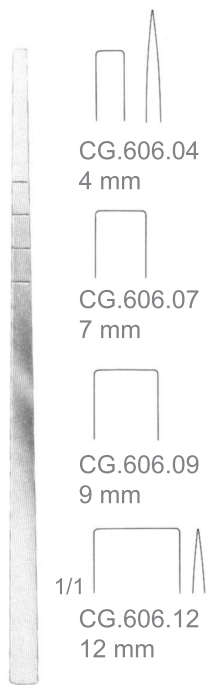

CG.606.04/12
Cottle
Rhinoplastic
Instruments etc

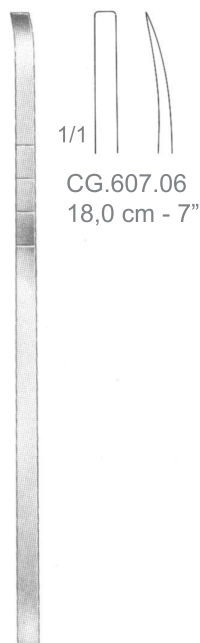

CG.607.06
Cottle
Rhinoplastic
Instruments etc

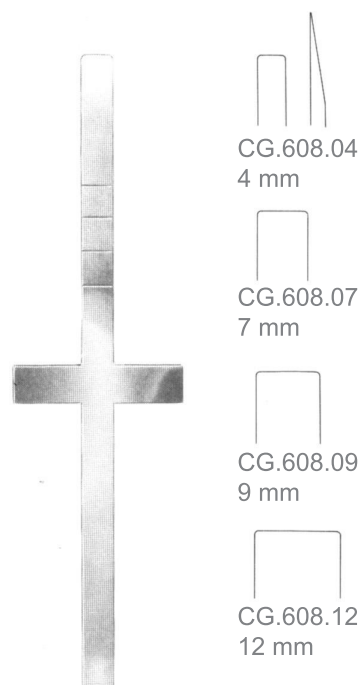

CG.608.04/12
Cottle
Rhinoplastic
Instruments etc



CG.609.06
Cottle
Rhinoplastic
Instruments etc

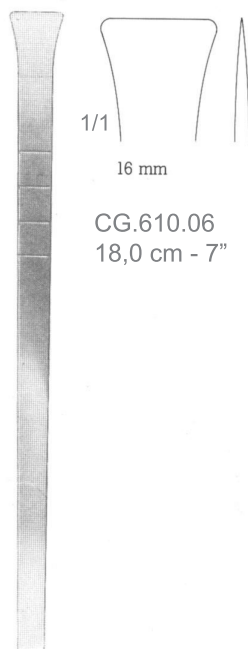

CG.610.06
Cottle
Rhinoplastic
Instruments etc

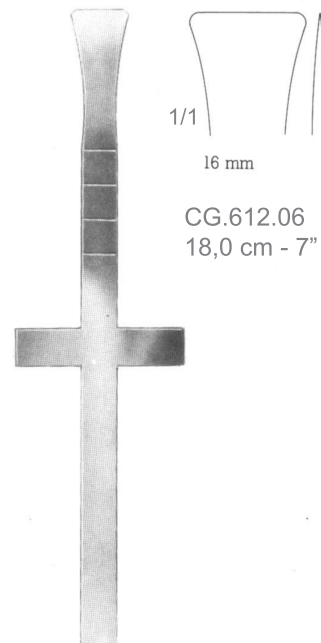

CG.612.06
Cottle
Rhinoplastic
Instruments etc

CG

CG.616.10/14
18,0 cm - 7"

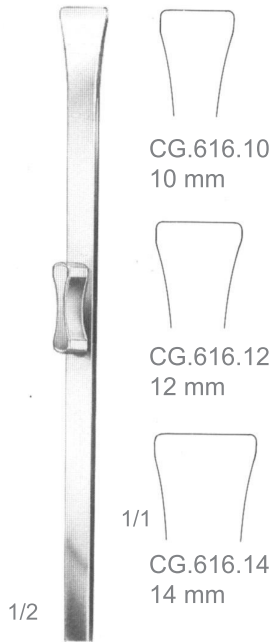

CG.616.10
10 mm

CG.616.12
12 mm

1/1
CG.616.14
14 mm

CG.616.10/14
Rubin
Rhinoplastic
Instruments etc

CG.620.03/04
19,0 cm - 7 3/4"

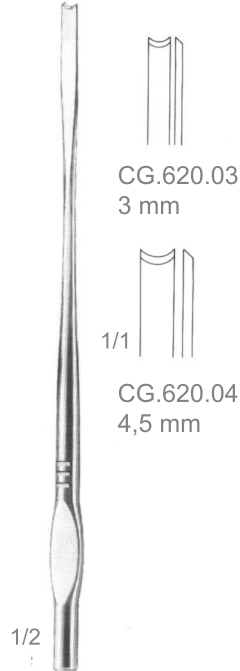

CG.620.03
3 mm

1/1
CG.620.04
4,5 mm

CG.620.03/04
Walter
Rhinoplastic
Instruments etc

CG.622.03/12
19,0 cm - 7 3/4"

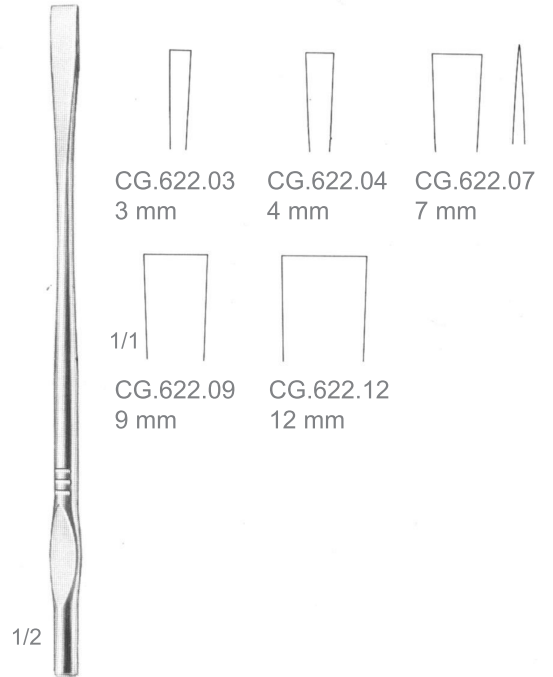

CG.622.03
3 mm

CG.622.04
4 mm

CG.622.07
7 mm

1/1
CG.622.09
9 mm

CG.622.12
12 mm

CG.622.03/12
Walter
Rhinoplastic
Instruments etc

CG.623.04/07
17,0 cm - 6 3/4"

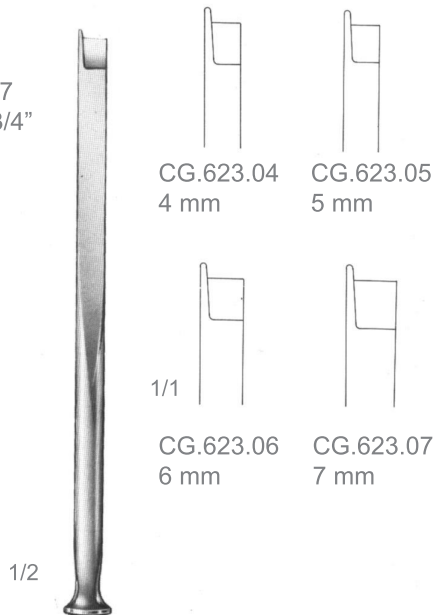

CG.623.04
4 mm

CG.623.05
5 mm

1/1
CG.623.06
6 mm

CG.623.07
7 mm

CG.623.04/07
Fomon
Rhinoplastic
Instruments etc

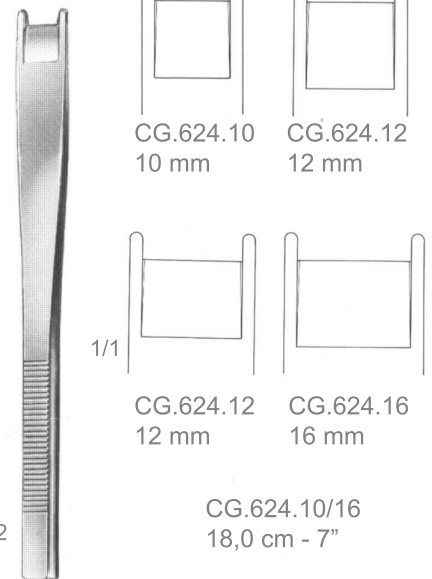

CG.624.10
10 mm

CG.624.12
12 mm

1/1
CG.624.12
12 mm

CG.624.16
16 mm

CG.624.10/16
18,0 cm - 7"

CG.624.10/16
Cinelli
Rhinoplastic
Instruments etc

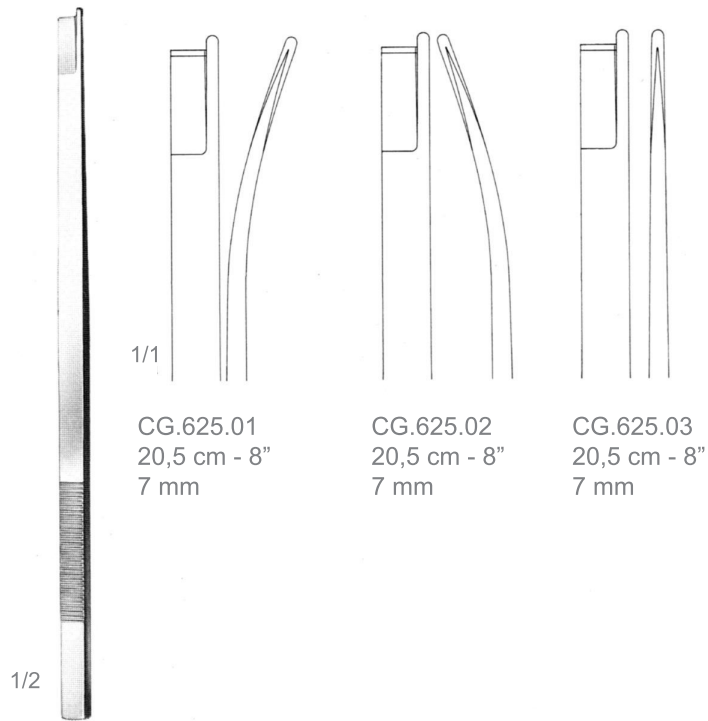

CG.625.01/03
Neivert-Anderson
Rhinoplastic
Instruments etc

CG

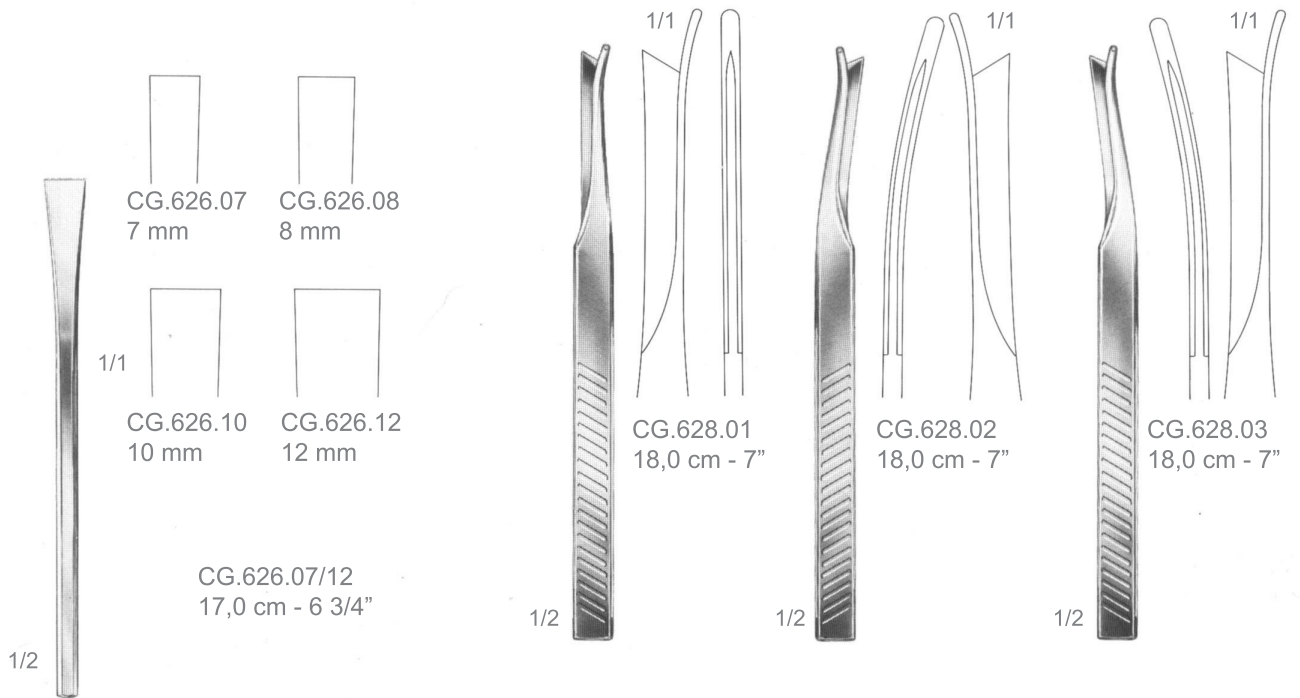

CG.626.07/12
Sheehan
Rhinoplastic
Instruments etc

CG.628.01/03
Silver
Rhinoplastic
Instruments etc

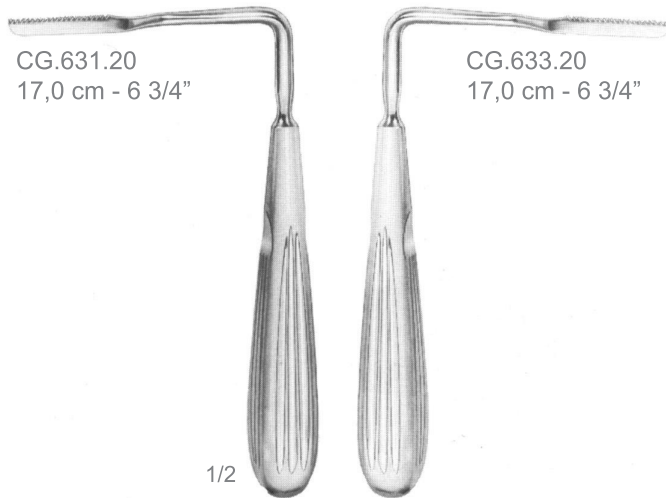

CG.631.20
CG.633.20
Joseph
Rhinoplastic
Instruments etc

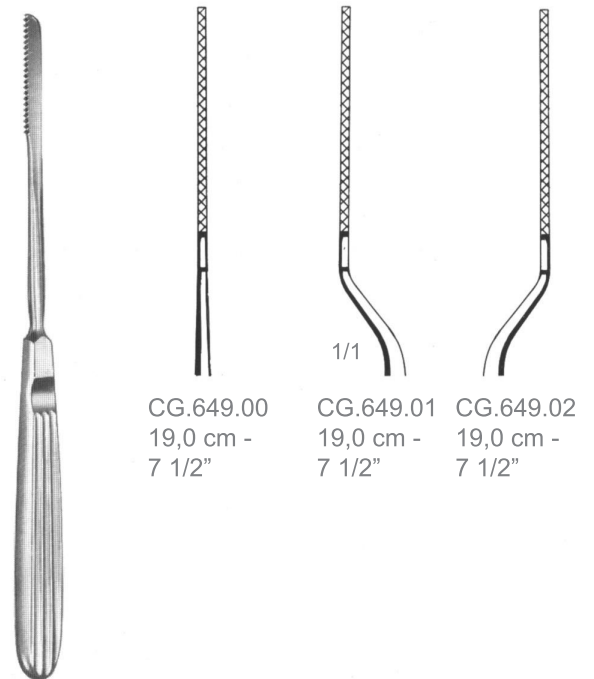

CG.649.00/02
Joseph
Rhinoplastic
Instruments etc

1/1

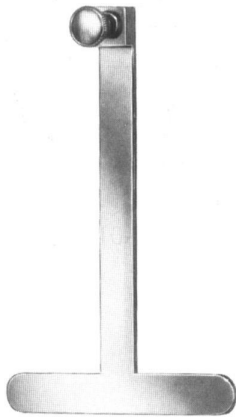

CG.650.01
Cottle
Rhinoplastic
Instruments etc

1/1



CG.650.02
Rhinoplastic
Instruments etc

1/1

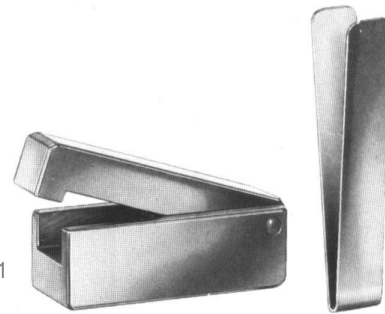

CG.652.00
Cottle
Rhinoplastic
Instruments etc

CG.650.01/02
CG.652.00

- Bone and cartilage guide
- Bone crusher

CG

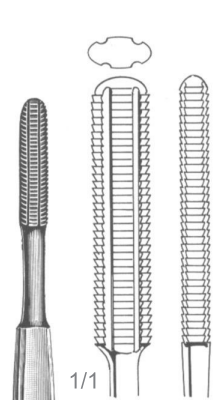

CG.654.18
18,0 cm - 7"

1/2

CG.654.18
Maltz
Rhinoplastic
Instruments etc

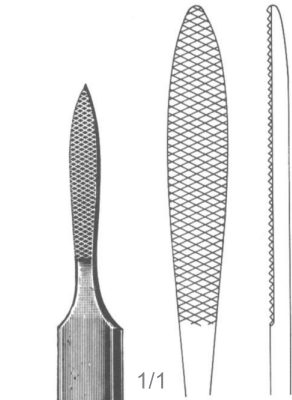

CG.658.01
16,0 cm - 6 1/4"

1/2

CG.658.01
Joseph
Rhinoplastic
Instruments etc

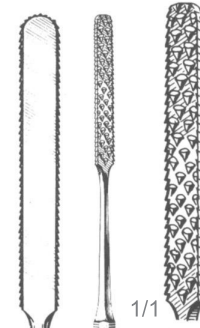

CG.669.01
16,0 cm -
6 1/4"

1/2

CG.669.01/03
Gallaher
Rhinoplastic
Instruments etc



CG.669.02
16,0 cm -
6 1/4"

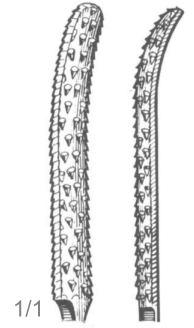

CG.669.03
16,0 cm -
6 1/4"

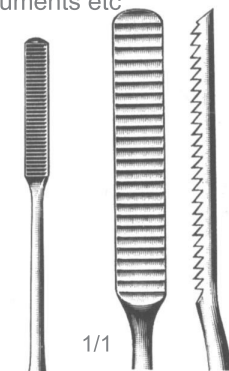

CG.670.21
21,0 cm - 8 1/4"

1/2

CG.670.21
Cottle
Rhinoplastic
Instruments etc

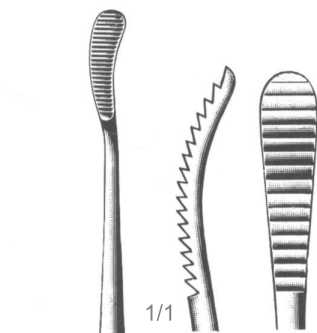

CG.671.21
21,0 cm - 8 1/4"

1/2

CG.671.21
CG.673.21
Aufrecht
Rhinoplastic
Instruments etc

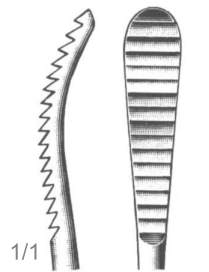

CG.673.21
21,0 cm - 8 1/4"



CG.674.18
18,0 cm - 7"
fine

CG.676.18
18,0 cm - 7"
coarse

1/2

CG.674.18
CG.676.18
Lewis
Rhinoplastic
Instruments etc



CG.677.18
18,0 cm - 7"

CG.679.18
18,0 cm - 7"

CG.677.18
CG.679.18
Wiener
Rhinoplastic
Instruments etc

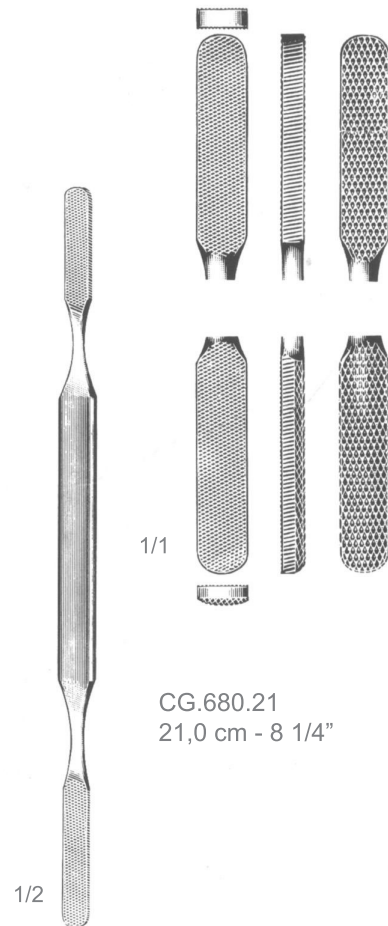

CG.680.21
21,0 cm - 8 1/4"

CG.680.21
Fomon
Rhinoplastic
Instruments etc



1/2

CG.682.01/05
Fomon
Rhinoplastic
Instruments etc

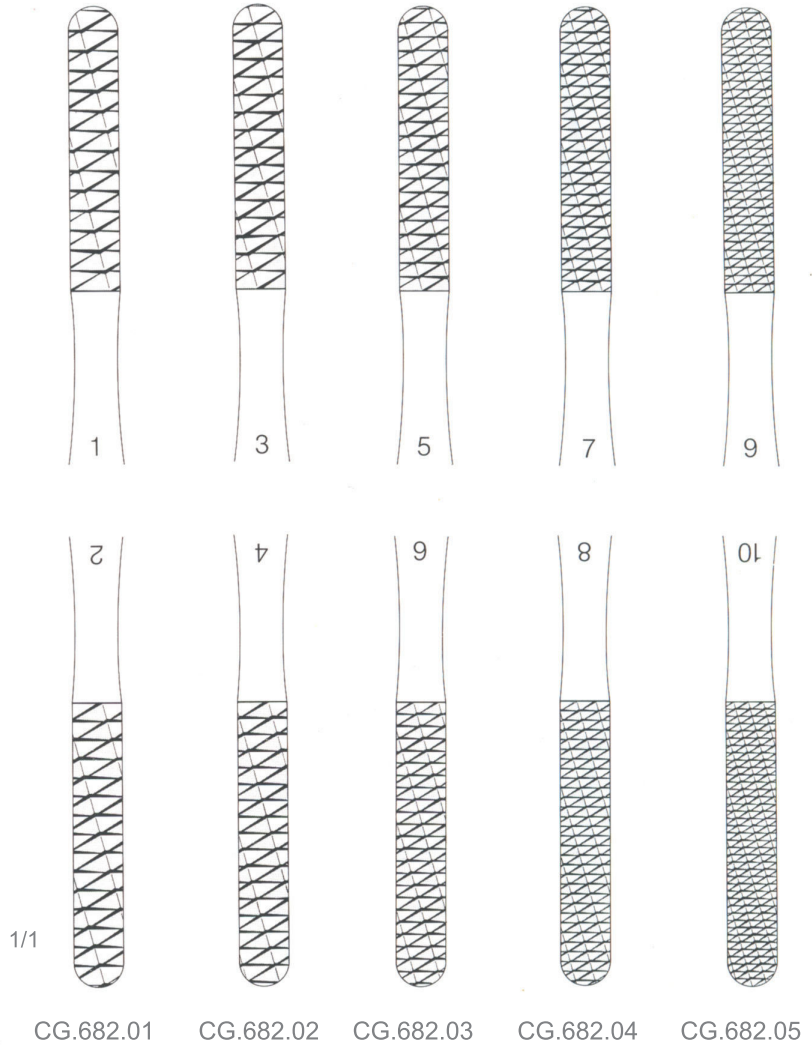

CG.682.01

CG.682.02

CG.682.03

CG.682.04

CG.682.05

CG.682.01/05
20,0 cm - 8"

CG.684.15
15,0 cm - 6"



1/2

CG.684.15
Joseph
Rhinoplastic
Instruments etc

CG.686.16
16,0 cm - 6 1/4"



1/2

CG.686.16
Cottle
Rhinoplastic
Instruments etc



1/2

CG.688.01/03
Rhinoplastic
Instruments etc

1/1

CG.688.01
15,0 cm -
6"

1/1

CG.688.02
15,0 cm -
6"

1/1

CG.688.03
15,0 cm -
6"

CG.692.22
22,0 cm - 8 3/4"



1/2

CG.692.22
Lange
Rhinoplastic
Instruments etc



1/2

CG.694.17
Fomon
Rhinoplastic
Instruments etc

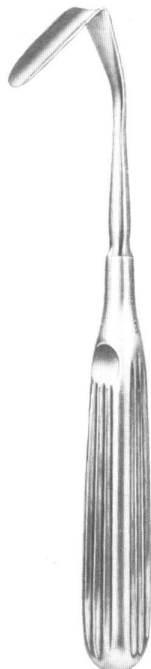

CG.697.19
19,0 cm - 7 1/2"

CG.697.19
Aufricht
Rhinoplastic
Instruments etc



1/1

CG.698.10
10,0 cm - 4"

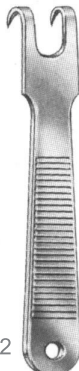

1/2

CG.698.10
Kilner
Rhinoplastic
Instruments etc

CG.700.12
12,0 cm - 4 3/4"



1/1

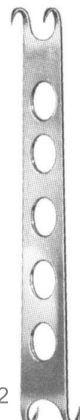

1/2

CG.700.12
Converse
Rhinoplastic
Instruments etc

CG.702.15
15,0 cm - 6"

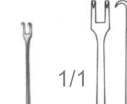

1/1

1/2

CG.702.15
Freer
Rhinoplastic
Instruments etc

CG.694.17
17,0 cm - 6 3/4"

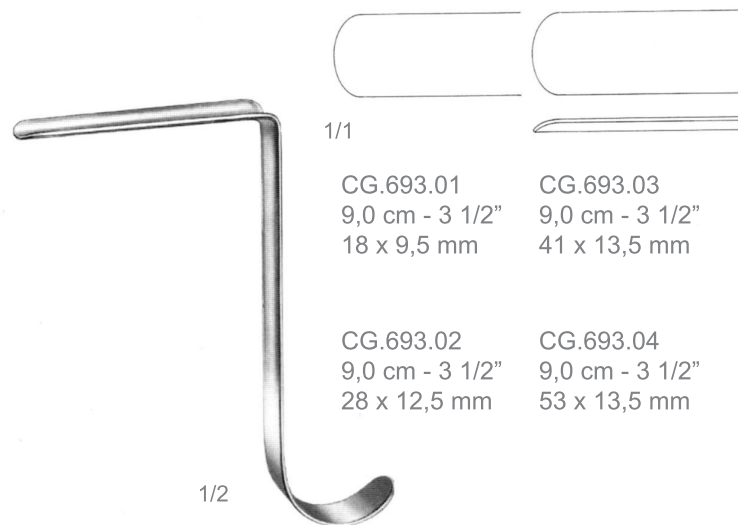

CG.693.01
9,0 cm - 3 1/2"
18 x 9,5 mm

CG.693.03
9,0 cm - 3 1/2"
41 x 13,5 mm

CG.693.02
9,0 cm - 3 1/2"
28 x 12,5 mm

CG.693.04
9,0 cm - 3 1/2"
53 x 13,5 mm

CG.693.01/04
Converse
Rhinoplastic
Instruments etc

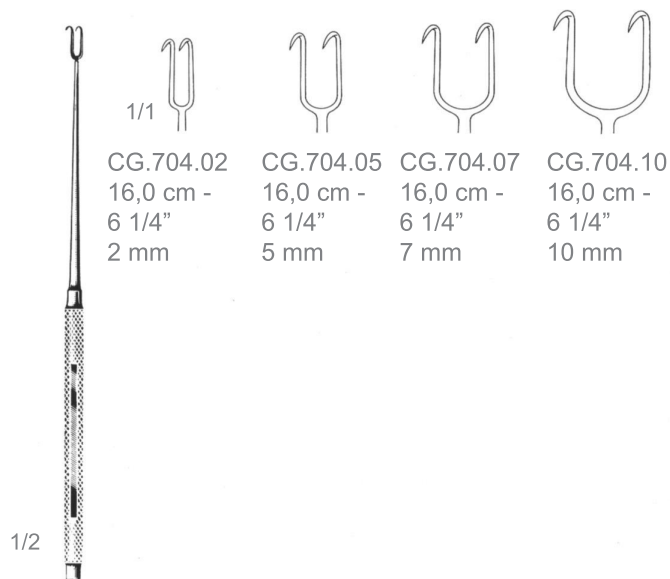

CG.704.02/10
Joseph
Rhinoplastic
Instruments etc



CG.706.16
Fomon
Rhinoplastic
Instruments etc

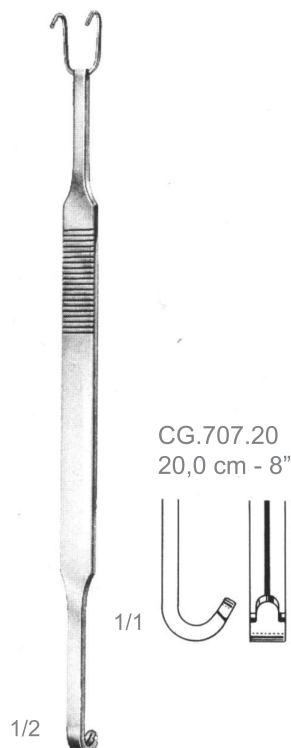

CG.707.20
Cottle-Neivert
Rhinoplastic
Instruments etc

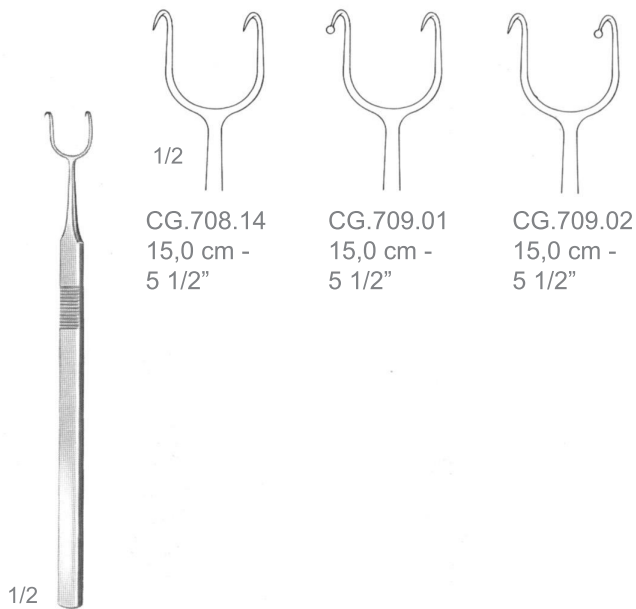

CG.708.14
CG.709.01/02
Cottle
Rhinoplastic
Instruments etc

CG

CG.710.14
14,0 cm - 5 1/2"



1/2

CG.710.14
Cottle
Rhinoplastic
Instruments etc

CG.712.16
16,0 cm - 6 1/4"



1/2

CG.712.16
Neivert
Rhinoplastic
Instruments etc

CG.713.15
15,0 cm - 6"



1/2

CG.713.15
Cottle
Rhinoplastic
Instruments etc

CG.714.15
15,0 cm - 6"

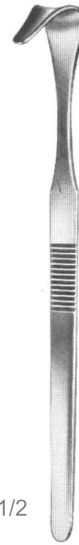

1/2

CG.714.15
Cottle
Rhinoplastic
Instruments etc

CG.715.14
13,5 cm - 5 1/4"



1/2

CG.715.14
Aufricht
Rhinoplastic
Instruments etc



1/2

CG.717.01/09
Yankauer
Rhinoplastic
Instruments etc



1/1

CG.717.01



CG.717.02



CG.717.03



CG.717.04



CG.717.05



CG.717.06



CG.717.07



CG.717.08



CG.717.09

CG.717.01/09 - Septum Suture Needles

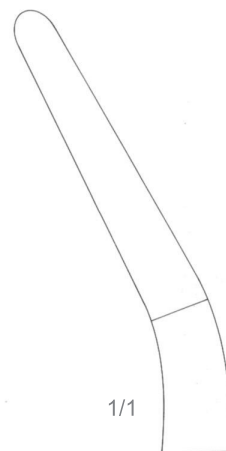
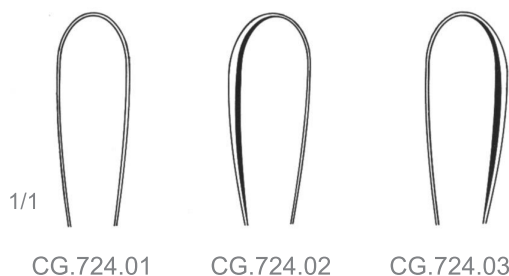

CG.721.20
20,0 cm - 8"



1/2

CG.721.20
Kressner
Rhinoplastic
Instruments etc

CG.724.01/03
23,0 cm - 9"

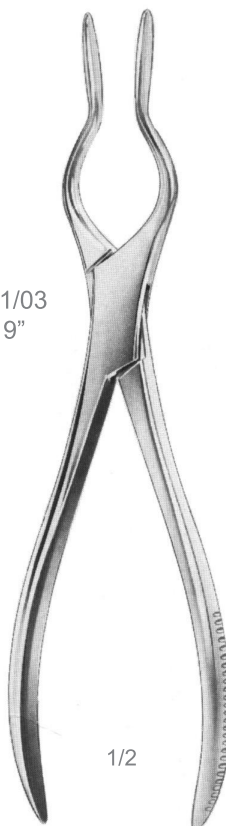

1/2

CG.724.01/03
Cottle-Walsham
Rhinoplastic
Instruments etc

CG.725.23
23,0 cm - 9"

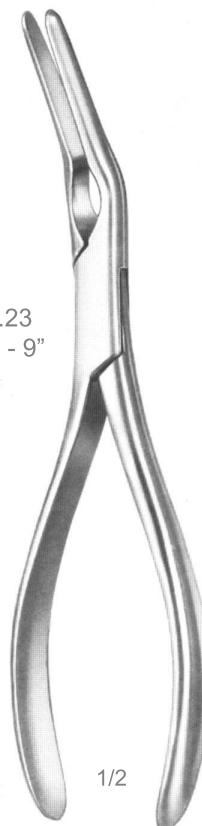

1/2

CG.725.23
Asch
Rhinoplastic
Instruments etc

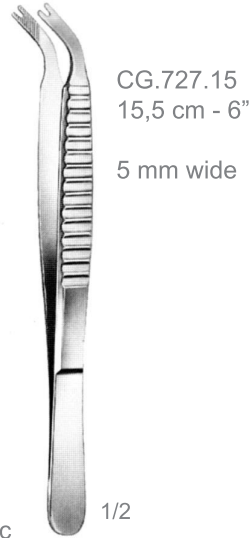

CG.727.15
15,5 cm - 6"
5 mm wide

CG.727.15
Aiach
Rhinoplastic
Instruments etc

1/2



1/1

1/1

1/2

CG.728.11
Ogura
Rhinoplastic
Instruments etc

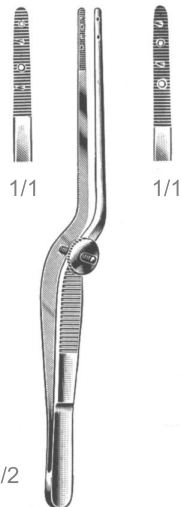

1/1

1/1

1/2

CG.731.14
Cottle
Rhinoplastic
Instruments etc



1/2

CG.732.10
Cottle
Rhinoplastic
Instruments etc

CG.728.11 - CG.731.14 - Tissue Forceps
CG.732.10 - Columella Forceps

CG.739.21
21,0 cm - 8 1/4"



1/2

CG.739.21
Pratt
Sharp Curettes

CG.741.21
21,0 cm - 8 1/4"



1/2

CG.741.21
Faulkner
Sharp Curettes



CG.747.01 CG.747.02 CG.747.03



CG.747.04 CG.747.05 CG.747.06

CG.747.01/06
17,0 cm - 6 3/4"



1/2

CG.747.01/06
Coakley
Sharp Curettes



1/1

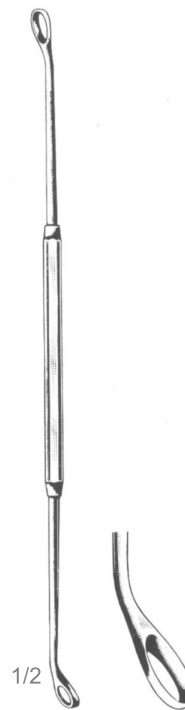

1/2

CG.749.12
Sharp Curettes

CG

CG.755.01/06
22,0 cm - 8 3/4"

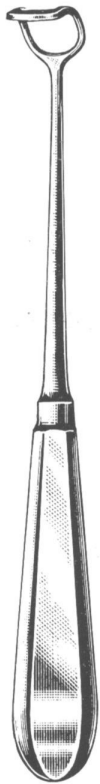

1/2

CG.755.01/06
Beckmann
Adenoid Currettes

CG.756.01/06
22,0 cm - 8 3/4"

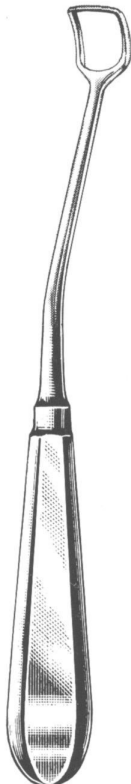

1/2

CG.756.01/06
Beckmann
Adenoid Currettes

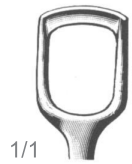

1/1

CG.755.01
CG.756.01



CG.755.02
CG.756.02



CG.755.03
CG.756.03

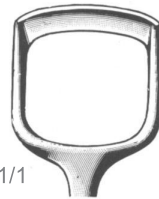

1/1

CG.755.04
CG.756.04



CG.755.05
CG.756.05

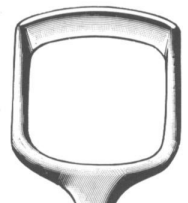

CG.755.06
CG.756.06

Adenoid Curettes

RINGMESSER - CUCHILLOS PARA VEGETACIONES ADENOIDES

Kolpen

RHINOLOGY
RHINOLOGIE
RINOLOGÍA

CG

CG.759.01/05
22,0 cm - 8 3/4"



1/2

CG.759.01/05
Beckmann
Adenoid Curettes

1/1

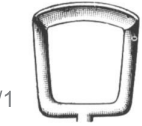

CG.759.01

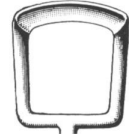

CG.759.02

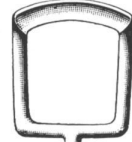

CG.759.03

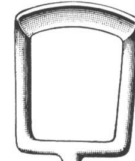

CG.759.04

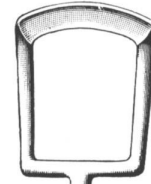

CG.759.05

CG.767.01/04
21,0 cm - 8 3/4"

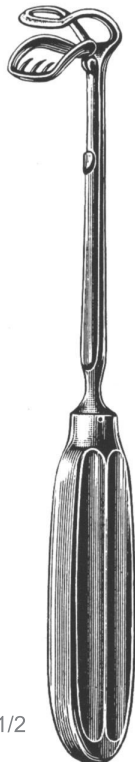

1/2

CG.767.01/04
St. Clair-Thomson
Adenoid Curettes

1/1

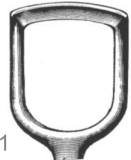

CG.767.01



CG.767.02



CG.767.03



CG.767.04

CG.771.01
CG.773.03
25,0 cm - 10"

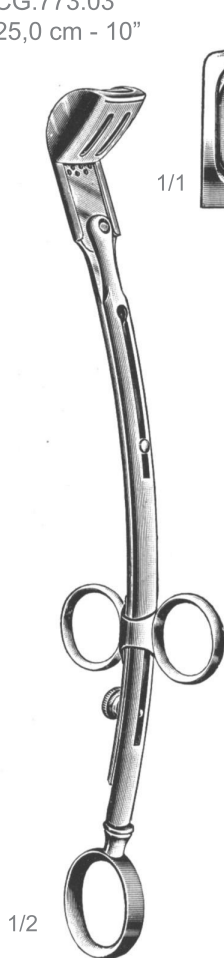

CG.771.01
CG.773.03

La Force
Adenotomes,
Antrum Retractor

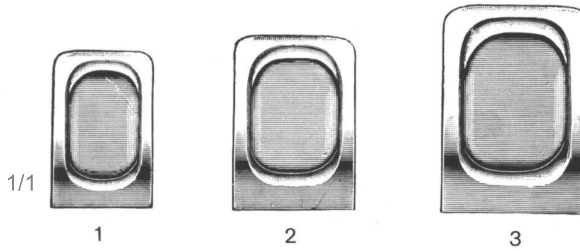

with unperforated blade	Fig.	with perforated blade
CG.771.01	1	CG.773.01
CG.771.02	2	CG.773.02
CG.771.03	3	CG.773.03

Spare Blades for CG.771.01 - CG.773.03

CG.781.01	1	CG.782.01
CG.781.02	2	CG.782.02
CG.781.03	3	CG.782.03

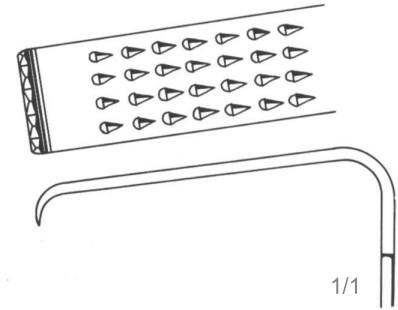

CG.785.19

Bruenings-Brunk
Adenotomes,
Antrum Retractor

CG.785.19
19,0 cm - 7 1/2"

CG.771.01 - CG.771.03 - Adenotomes, with one spare blade
CG.781.01 - CG.782.03 - Spare Blades only
CG.785.19 - Antrum Retractor

Antrum and Frontal Sinus Wash Cannulas, Wash Catheters, Probes

Kolpen

KIEFER- UND STIRNHÖHLEN-SPÜLKANÜLEN, SPÜLKATHETER, SONDEN -
 CÁNULAS LAVADORAS PARA SENOS MAXILAR Y FRONTAL, CATÉTERES LAVA-
 DORES, ESTILETES

RHINOLOGY
 RHINOLOGIE
 RINOLOGÍA



CG.804.15
 17,0 cm - 6 3/4"
 1,5 mm Ø

CG.804.20
 17,0 cm - 6 3/4"
 2,0 mm Ø

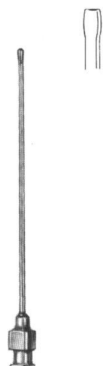

CG.804.15/20

Hajak
 Antrum and Frontal
 Sinus Wash Cannulas

CG.807.20
 12,0 cm - 4 3/4"
 2,0 mm Ø

CG.807.25
 12,0 cm - 4 3/4"
 2,5 mm Ø

CG.807.30
 12,0 cm - 4 3/4"
 3,0 mm Ø

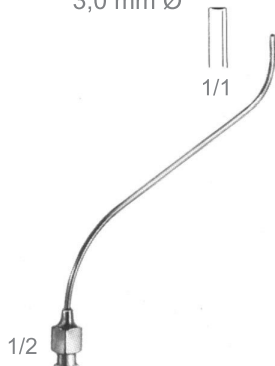

CG.807.20/30

Hartmann
 Antrum and Frontal
 Sinus Wash Cannulas

CG.810.09
 9,0 cm - 3 1/2"
 1,8 mm Ø

CG.810.09
 9,0 cm - 3 1/2"
 1,8 mm Ø



CG.810.09/11

Myles
 Antrum and Frontal
 Sinus Wash Cannulas

CG.815.30
 14,0 cm - 5 1/2"
 3 mm Ø



CG.815.30

Eicken-Killen
 Antrum
 and Frontal
 Sinus
 Wash Cannulas

CG.817.30
 14,0 cm - 5 1/2"
 3 mm Ø



CG.817.30

Eicken-Killen
 Antrum
 and Frontal
 Sinus
 Wash Cannulas

CG.821.15
 17,0 cm - 6 3/4"
 1,5 mm Ø



CG.821.15

Killen
 Antrum
 and Frontal
 Sinus
 Wash Cannulas

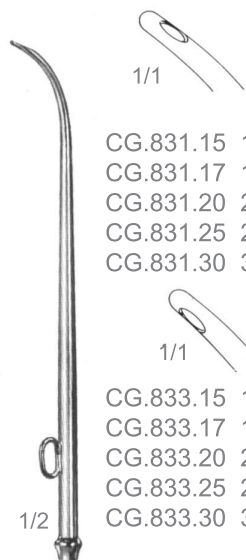

CG.831.15 1,5 mm Ø
 CG.831.17 1,7 mm Ø
 CG.831.20 2,0 mm Ø
 CG.831.25 2,5 mm Ø
 CG.831.30 3,0 mm Ø

CG.833.15 1,5 mm Ø
 CG.833.17 1,7 mm Ø
 CG.833.20 2,0 mm Ø
 CG.833.25 2,5 mm Ø
 CG.833.30 3,0 mm Ø

CG.831.15/30

CG.833.15/30

Siebenmann
 Antrum
 and Frontal
 Sinus
 Wash Cannulas

CG.841.25 2,5 mm Ø
 CG.841.30 3,0 mm Ø
 CG.841.40 4,0 mm Ø

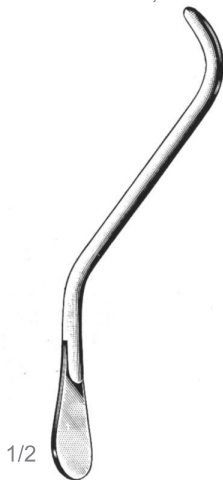

CG.841.25/40

Ritter-Halle
 Antrum and Frontal
 Sinus Wash Cannulas



CG.840.20
 20,0 cm - 8"

CG.840.20

Guilen
 Antrum
 and Frontal
 Sinus
 Wash Cannulas

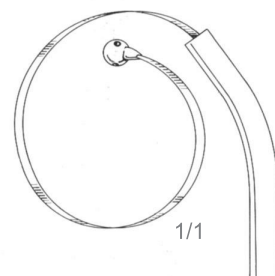

CG.849.14
 14,0 cm - 5 1/2"
 with screw

CG.849.14

Belloccq
 Antrum
 and Frontal
 Sinus
 Wash Cannulas

CG.831.15 - CG.833.30
 CG.841.25 - CG.841.40
 CG.849.14

- Antrum Wash Cannulas
 - Frontal Sinus Dilators
 - Epistaxis Cannulas

CG

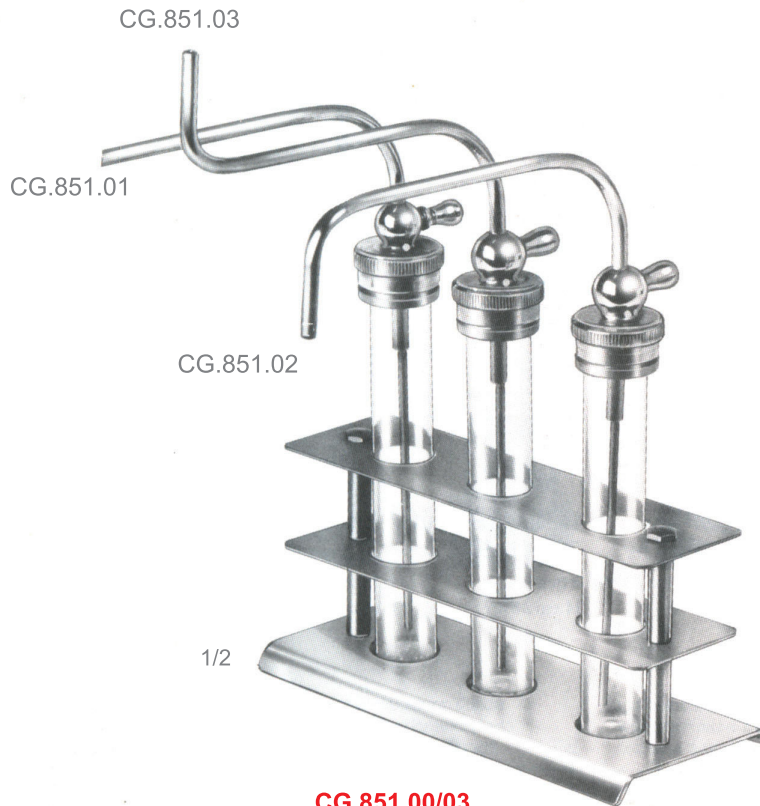

CG.851.00/03
Gruenwald
Atomizers



CG.851.04
Gruenwald
Atomizers



CG.851.05

1/2

- CG.851.00 - Set of 3 Gruenwald atomizers, complete with glass bottles on rack, without rubber bulb
- CG.851.01 - Gruenwald atomizer with straight cannula
- CG.851.02 - ditto, with downwards curved cannula
- CG.851.03 - ditto, with upwards curved cannula
- CG.851.04 - Gruenwald threaded spare bottle, only
- CG.851.05 - Rubber bulb

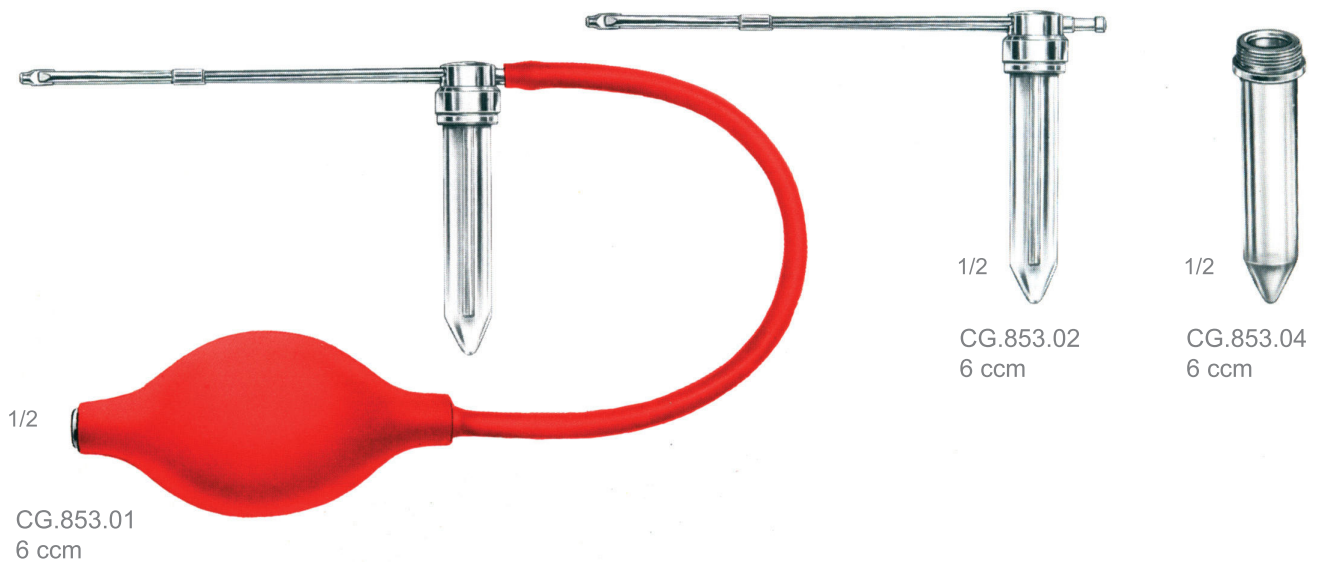
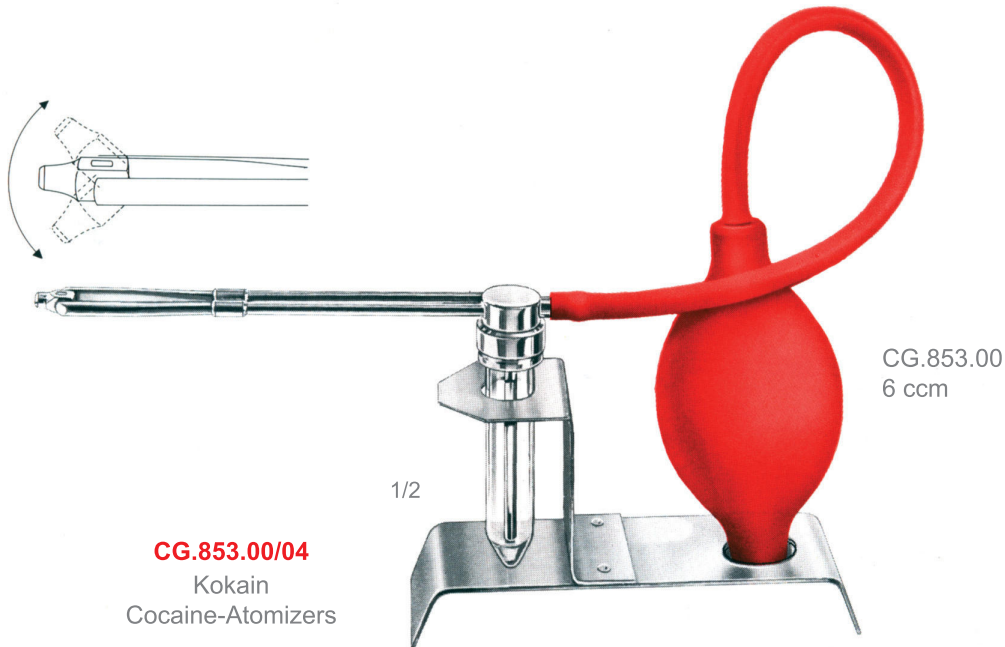

- CG.853.00 - Cocaine atomizer with 6 cc glass bottle, with mobile nozzle, metal base plate, and rubber bulb
- CG.853.01 - ditto, without metal base plate
- CG.853.02 - ditto, without rubber bulb and without metal base plate
- CG.853.03 - Metal base plate only for CG.853.00
- CG.853.04 - Threaded glass bottle only for CG.853.00
- CG.853.05 - Rubber bulb

CG

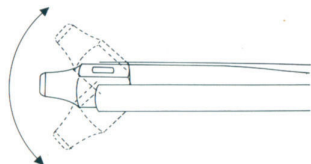

CG.855.00
30 ccm

1/2

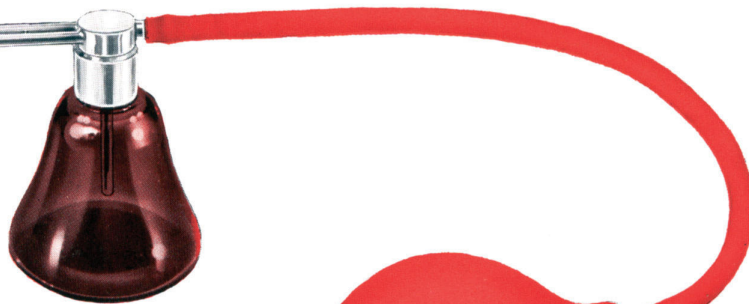

CG.855.00/05
Universal
Atomizers

CG.855.05

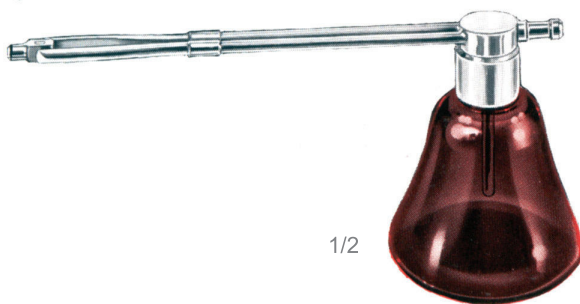
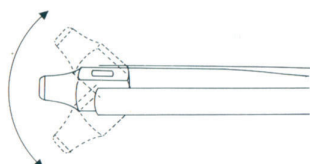

1/2

CG.855.01
30 ccm

CG.855.00 - Universal Atomizer with mobile and adjustable nozzle for nose, pharynx, and larynx, with brown threaded glass bottle 30 cc and rubber bulb

CG.855.01 - ditto, without rubber bulb

CG.855.05 - Rubber bulb, only