

Kolpen

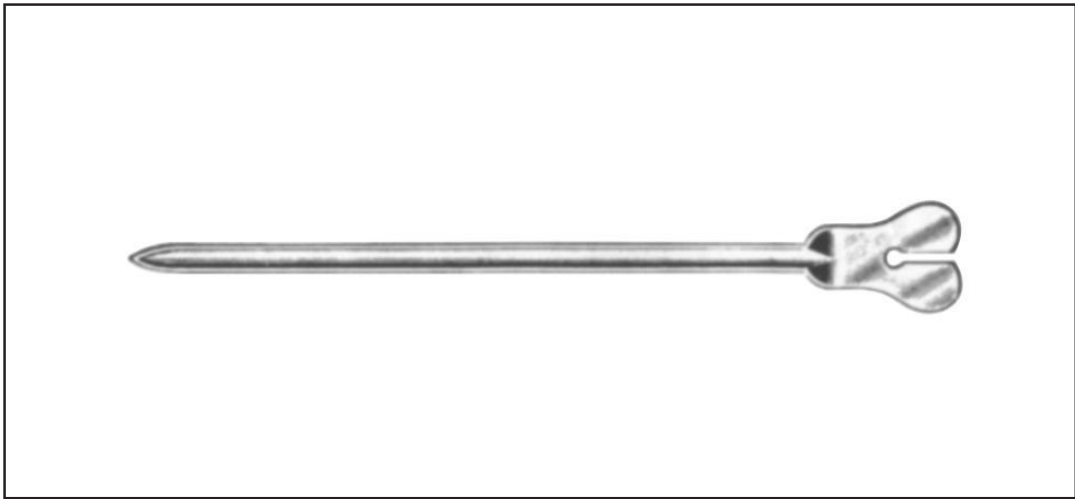

AF

AF



AF.100.11	11,5 cm - 4 1/2"
AF.100.13	13,0 cm - 5"
AF.100.14	14,5 cm - 5 1/2"
AF.100.16	16,0 cm - 6 1/4"
AF.100.18	18,0 cm - 7"
AF.100.20	20,0 cm - 8"
AF.100.25	25,0 cm - 10"
2 mm Ø	

AF.100.11/25
Probes



AF.102.11	11,5 cm - 4 1/2"
AF.102.13	13,0 cm - 5"
AF.102.14	14,5 cm - 5 1/2"
AF.102.16	16,0 cm - 6 1/4"
AF.102.18	18,0 cm - 7"
AF.102.20	20,0 cm - 8"
1 mm Ø	

AF.102.11/20
Probes



AF.104.14	14,5 cm - 5 1/2"
AF.104.16	16,0 cm - 6 1/4"
2 mm Ø	

AF.104.14/16
Probes



AF.106.14	14,5 cm - 5 1/2"
AF.106.16	16,0 cm - 6 1/4"
2 mm Ø	

AF.106.14/16
Probes



AF.108.13 13,0 cm - 5"
AF.108.14 14,5 cm - 5 1/2"
AF.108.16 16,0 cm - 6 1/4"
AF.108.18 18,0 cm - 7"
AF.108.20 20,0 cm - 8"
AF.108.25 25,0 cm - 10"
2 mm Ø

AF.108.13/25
Probes



AF.120.14 14,5 cm - 5 1/2"
AF.120.18 18,0 cm - 7"
2 mm Ø

AF.120.14/18
Fish
Probes

1/1



AF.130.10 10,5 cm - 4 1/4"
1 mm Ø

AF.130.10
Stacke
Probes



AF.150.14 14,5 cm - 5 1/2"
AF.150.16 16,0 cm - 6 1/4"
AF.150.20 20,0 cm - 8"

AF.150.14/20
Probes

AF



AF.160.11	11,5 cm - 4 1/2"
AF.160.13	13,0 cm - 5"
AF.160.14	14,5 cm - 5 1/2"
AF.160.16	16,0 cm - 6 1/4"
AF.160.18	18,0 cm - 7"
AF.160.20	20,0 cm - 8"

AF.160.11/20
Probes



AF.170.13	13,0 cm - 5"
AF.170.14	14,5 cm - 5 1/2"
AF.170.16	16,0 cm - 6 1/4"
AF.170.18	18,0 cm - 7"

AF.170.13/18
Probes



1/1

AF.175.14 14,0 cm - 5 1/2"

AF.175.14
Doyen
Probes



1/1

AF.185.16 16,0 cm - 6 1/4"

AF.185.16
Nélaton
Probes

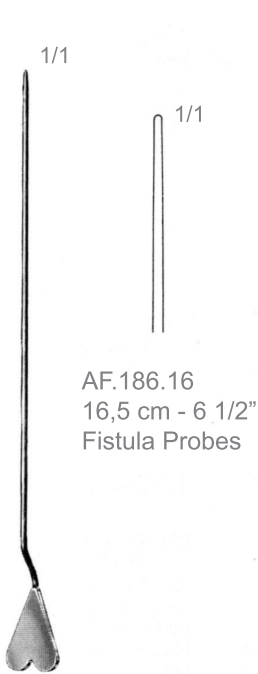

AF.186.16
16,5 cm - 6 1/2"
Fistula Probes

AF.186.16
Lockhart-Mummery
Probes

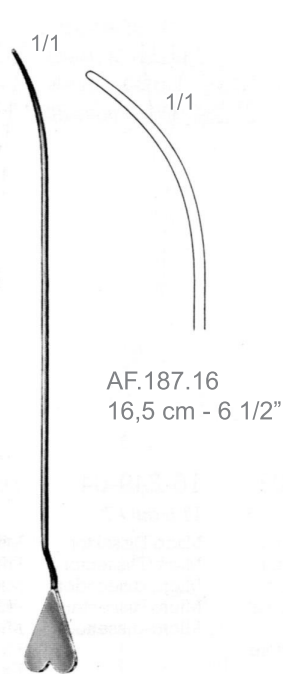

AF.187.16
16,5 cm - 6 1/2"

AF.187.16
Lockhart-Mummery
Probes

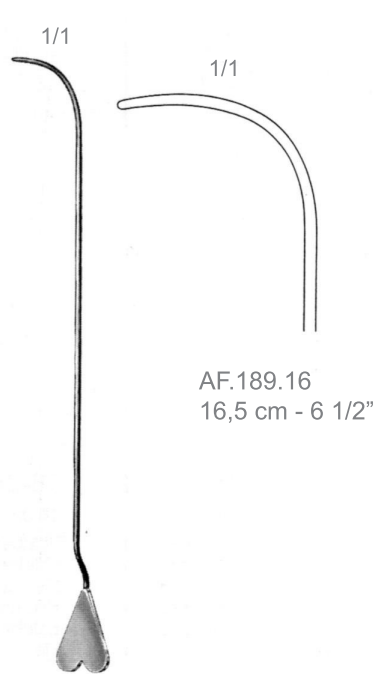

AF.189.16
16,5 cm - 6 1/2"

AF.189.16
Lockhart-Mummery
Probes

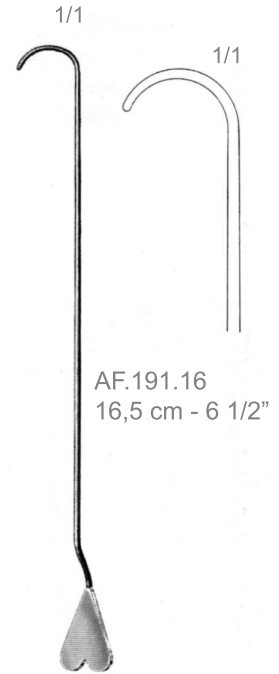

AF.191.16
16,5 cm - 6 1/2"

AF.191.16
Lockhart-Mummery
Probes

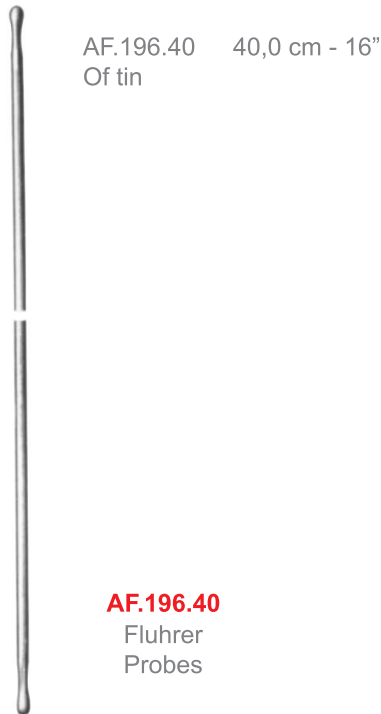

AF.196.40 40,0 cm - 16"
Of tin

AF.196.40
Fluhrer
Probes

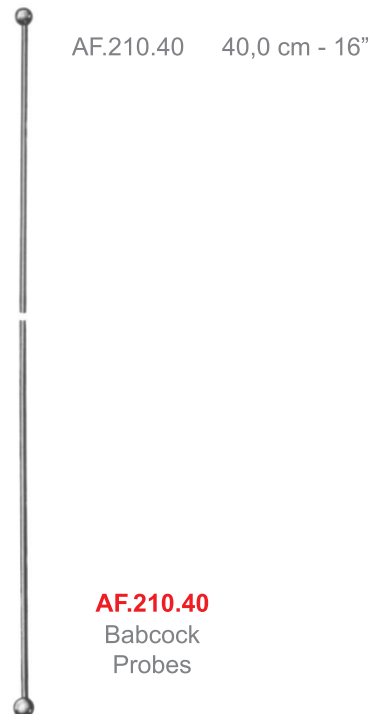

AF.210.40 40,0 cm - 16"

AF.210.40
Babcock
Probes

AF



1/1



AF.248.00
Papillotom, complete
with 3 cones

AF.248.00
Probes



1/1



AF.248.01
Probe, malleable,
only

AF.248.01
Probes



AF.248.03
Probes

AF.248.03
Set of cones

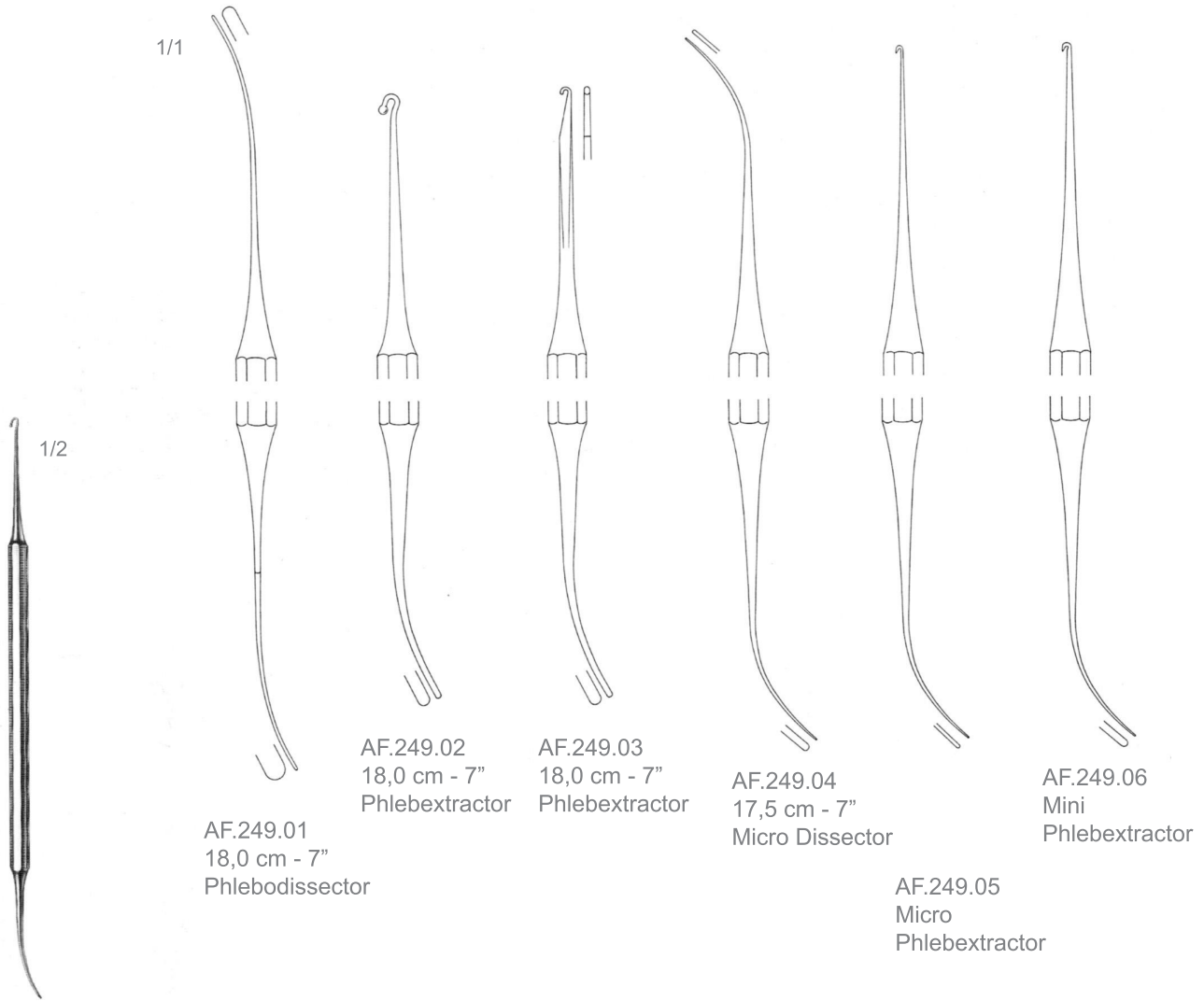

AF.249.01/06

Varady
Varix Instruments

AF

AF.250.00
135 x 100 x 25 mm

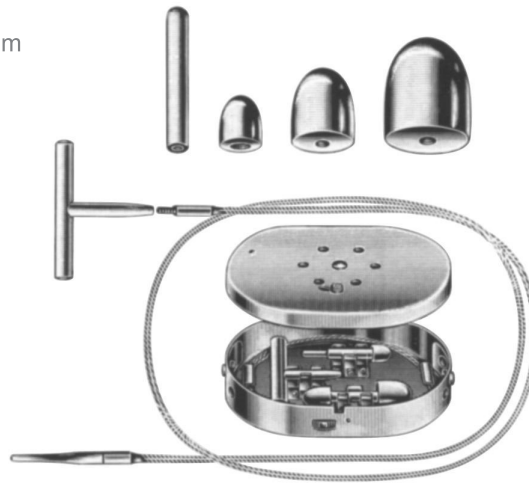

AF.250.00

Nabatoff
Varicose Vein
Probe Set

AF.250.95
Metal case

- AF.250.00 Varicose Vein Probe Set, in metal case, sterilizable, consisting of:
- AF.250.02 Probe Tip, plastic material
 - AF.250.03 Olive, 3 mm Ø
 - AF.250.06 ditto, 6 mm Ø
 - AF.250.09 ditto, 9 mm Ø
 - AF.250.12 ditto, 12 mm Ø
 - AF.250.80 Handle only
 - AF.250.90 Cable, flexible
 - AF.250.95 Metal case

AF.250.02
Probe Tip,
plastic material

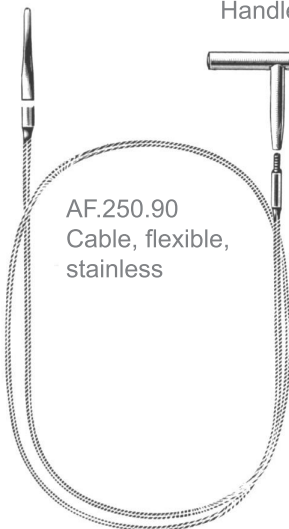

AF.250.80
Handle Only

AF.250.90
Cable, flexible,
stainless



1/1

AF.250.03
Olive, 3 mm Ø



AF.250.06
Ditto, 6 mm Ø



1/1

AF.250.09
Ditto, 9 mm Ø



AF.250.12
Ditto, 12 mm Ø

Ring Strippers

RINGSTRIPPER - DESOBLITERADORES DE VASOS

Kolpen

GENERAL INSTRUMENTS
ALLGEMEINES INSTRUMENTARIUM
INSTRUMENTAL GENERAL

AF



AF.251.02/14
Vollmar
Ring Strippers

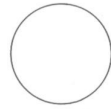

AF.251.02	50,0 cm - 20"	2 mm Ø
AF.251.03	50,0 cm - 20"	3 mm Ø
AF.251.04	50,0 cm - 20"	4 mm Ø
AF.251.06	50,0 cm - 20"	6 mm Ø
AF.251.07	50,0 cm - 20"	7 mm Ø
AF.251.08	50,0 cm - 20"	8,5 mm Ø
AF.251.10	50,0 cm - 20"	10 mm Ø
AF.251.12	50,0 cm - 20"	12 mm Ø
AF.251.14	50,0 cm - 20"	14 mm Ø

Ring Strippers



1/2

AF.251.30
Handle for Ring
Strippers

AF.251.30
12,0 cm - 4 3/4"
Handle for Ring Strippers

AF



AF.253.04/10
Vollmar
Ring Strippers



AF.253.04	50,0 cm - 20"	5,2 x 4,0 mm
AF.253.05	50,0 cm - 20"	6,5 x 5,0 mm
AF.253.06	50,0 cm - 20"	7,8 x 6,0 mm
AF.253.07	50,0 cm - 20"	9,0 x 7,0 mm
AF.253.08	50,0 cm - 20"	10,5 x 8,0 mm
AF.253.09	50,0 cm - 20"	11,5 x 9,0 mm
AF.253.10	50,0 cm - 20"	13,0 x 10,0 mm

Ovales Ring Strippers



1/1



AF.410.12	12,0 cm - 4 3/4"
AF.410.14	12,0 cm - 4 3/4"
AF.410.16	12,0 cm - 4 3/4"
AF.410.18	12,0 cm - 4 3/4"
	1,2 mm Ø



AF.412.12	12,0 cm - 4 3/4"
AF.412.14	12,0 cm - 4 3/4"
AF.412.16	12,0 cm - 4 3/4"
AF.412.18	12,0 cm - 4 3/4"
	1,5 mm Ø



AF.414.12	12,0 cm - 4 3/4"
AF.414.14	12,0 cm - 4 3/4"
AF.414.16	12,0 cm - 4 3/4"
AF.414.18	12,0 cm - 4 3/4"
	1,5 mm Ø

AF.410.12/18
AF.412.12/18
AF.414.12/18

Mod. Martin
Cotton Applicators

1/1



AF.420.12	12,0 cm - 4 3/4"	0,9 mm Ø
AF.420.14	14,0 cm - 5 1/2"	0,9 mm Ø
AF.420.16	16,5 cm - 6 1/2"	1,1 mm Ø
AF.420.18	18,0 cm - 7"	1,2 mm Ø

1/1



AF.426.12	12,0 cm - 4 3/4"	0,9 mm Ø
AF.426.14	14,0 cm - 5 1/2"	0,9 mm Ø
AF.426.16	16,5 cm - 6 1/2"	1,1 mm Ø
AF.426.18	18,0 cm - 7"	1,2 mm Ø

AF.420.12/18

Farrel (Lathbury-
Uebe)
Cotton Applicators

AF.426.12/18

Farrel
Cotton Applicators

AF

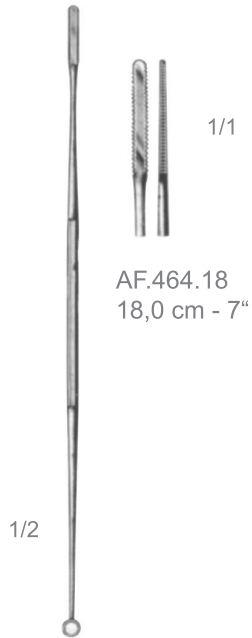

AF.464.18
Jobson-Horne
Cotton Applicators



AF.468.16
Mod. Martin
Cotton Applicators

Cotton Applicators, sponge holders, cotton carrier for rectoscopes

WATTETERÄGER, SCHWAMMHALTER, WATTETERÄGER FÜR REKTOSKOPE
PORTA-ALGODONES, PORTA-ESPONJAS, PORTA-ALGODÓN
PARA RECTOSCOPIOS

Kolpen

GENERAL INSTRUMENTS
ALLGEMEINES INSTRUMENTARIUM
INSTRUMENTAL GENERAL

AF

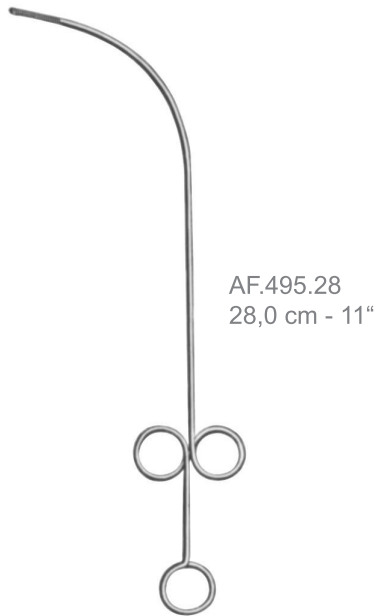

AF.495.28
28,0 cm - 11"

AF.495.28
Feint
Cotton Applicators

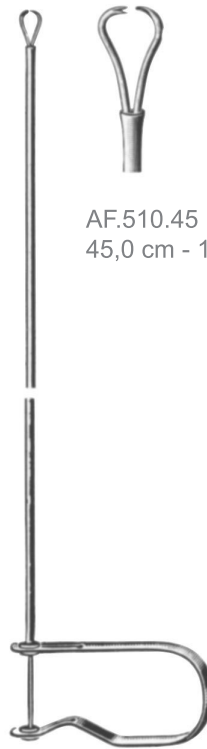

AF.510.45
45,0 cm - 17 3/4"

AF.510.45
Cotton Applicators



AF.515.40
40,0 cm - 15 3/4"

AF.515.40
Cotton Applicators



AF.563.31
31,0 cm - 12 1/4"

AF.563.31
Playfair
Cotton Applicators