

# Kolpen

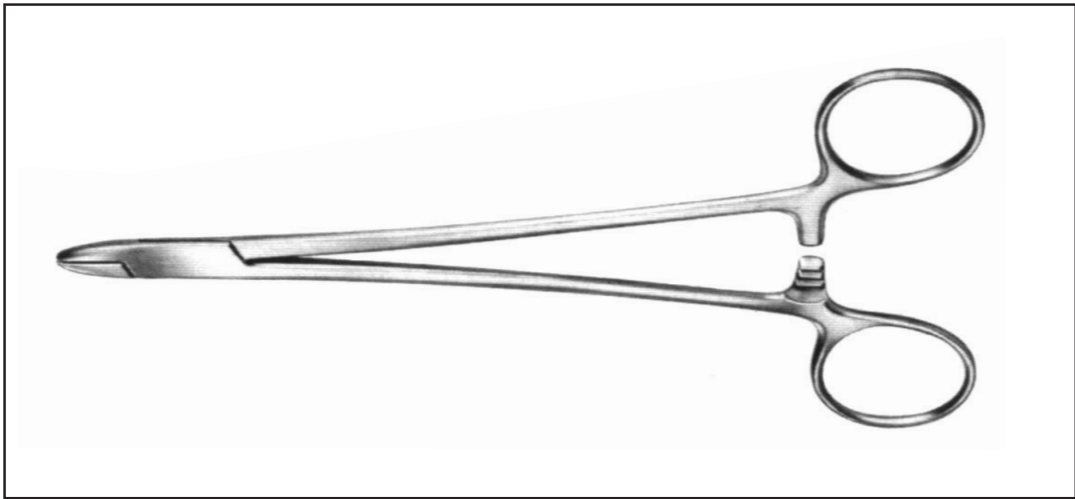

---

**B X**

**BX**

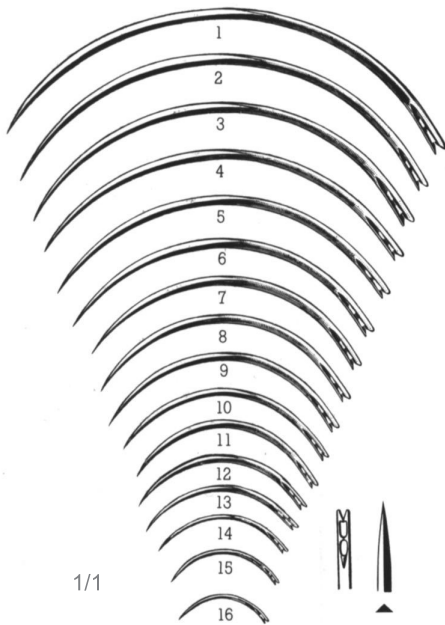

**BX.113.01/16**

B

Muscular and  
Skin Suture,  
Intestinal Suture

- Fig. 1 BX.113.01
- Fig. 2 BX.113.02
- Fig. 3 BX.113.03
- Fig. 4 BX.113.04
- Fig. 5 BX.113.05
- Fig. 6 BX.113.06
- Fig. 7 BX.113.07
- Fig. 8 BX.113.08
- Fig. 9 BX.113.09
- Fig. 10 BX.113.10
- Fig. 11 BX.113.11
- Fig. 12 BX.113.12
- Fig. 13 BX.113.13
- Fig. 14 BX.113.14
- Fig. 15 BX.113.15
- Fig. 16 BX.113.16

Curved 3/8 Circle

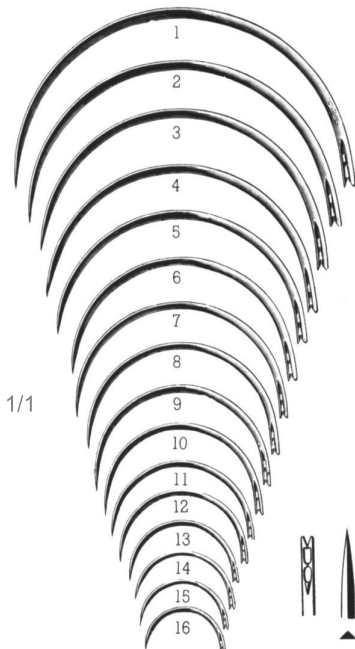

**BX.133.01/16**

G

Muscular and  
Skin Suture,  
Intestinal Suture

- Fig. 1 BX.123.01
- Fig. 2 BX.123.02
- Fig. 3 BX.123.03
- Fig. 4 BX.123.04
- Fig. 5 BX.123.05
- Fig. 6 BX.123.06
- Fig. 7 BX.123.07
- Fig. 8 BX.123.08
- Fig. 9 BX.123.09
- Fig. 10 BX.123.10
- Fig. 11 BX.123.11
- Fig. 12 BX.123.12
- Fig. 13 BX.123.13
- Fig. 14 BX.123.14
- Fig. 15 BX.123.15
- Fig. 16 BX.123.16

Curved 1/2 Circle

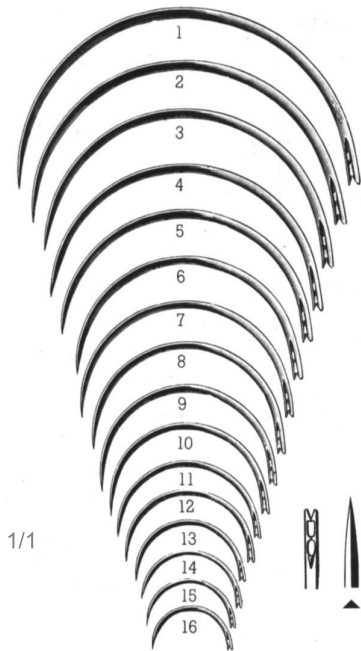

**BX.127.01/16**

Gr

Muscular and  
Skin Suture,  
Intestinal Suture

- Fig. 1 BX.127.01
- Fig. 2 BX.127.02
- Fig. 3 BX.127.03
- Fig. 4 BX.127.04
- Fig. 5 BX.127.05
- Fig. 6 BX.127.06
- Fig. 7 BX.127.07
- Fig. 8 BX.127.08
- Fig. 9 BX.127.09
- Fig. 10 BX.127.10
- Fig. 11 BX.127.11
- Fig. 12 BX.127.12
- Fig. 13 BX.127.13
- Fig. 14 BX.127.14
- Fig. 15 BX.127.15
- Fig. 16 BX.127.16

Curved 1/2 Circle

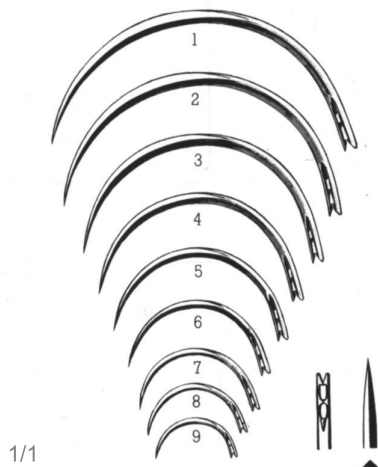

**BX.133.01/09**

Ga

Muscular and  
Skin Suture,  
Intestinal Suture

- Fig. 1 BX.133.01
- Fig. 2 BX.133.02
- Fig. 3 BX.133.03
- Fig. 4 BX.133.04
- Fig. 5 BX.133.05
- Fig. 6 BX.133.06
- Fig. 7 BX.133.07
- Fig. 8 BX.133.08

Curved 1/2 Circle

**BX**

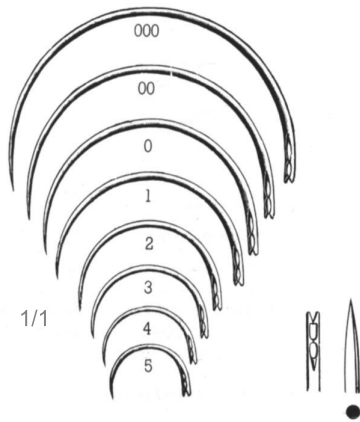

**BX.154.10/30**  
**BX.155.01/05**

E  
Muscular and  
Skin Suture,  
Intestinal Suture

Fig. 000 BX.154.30  
Fig. 00 BX.154.20  
Fig. 0 BX.154.10  
Fig. 1 BX.155.01  
Fig. 2 BX.155.02  
Fig. 3 BX.155.03  
Fig. 4 BX.155.04  
Fig. 5 BX.155.05  
Curved 1/2 Circle

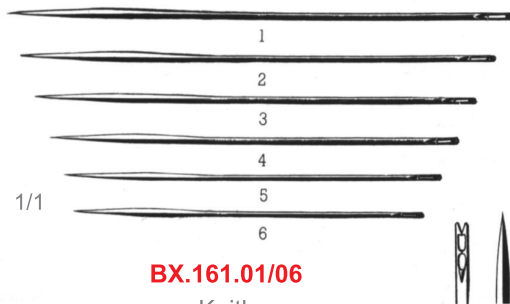

**BX.161.01/06**

Keith  
Muscular and  
Skin Suture,  
Intestinal Suture

Fig. 1 BX.161.01  
Fig. 2 BX.161.02  
Fig. 3 BX.161.03  
Fig. 4 BX.161.04  
Fig. 5 BX.161.05  
Fig. 6 BX.161.06

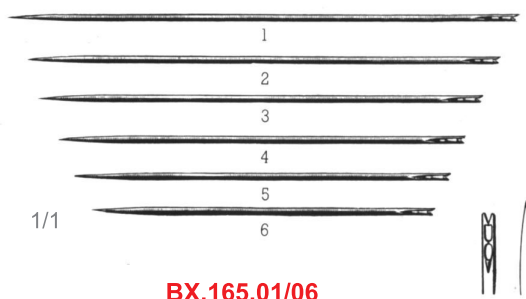

**BX.165.01/06**

Keith  
Muscular and  
Skin Suture,  
Intestinal Suture

Fig. 1 BX.165.01  
Fig. 2 BX.165.02  
Fig. 3 BX.165.03  
Fig. 4 BX.165.04  
Fig. 5 BX.165.05  
Fig. 6 BX.165.06

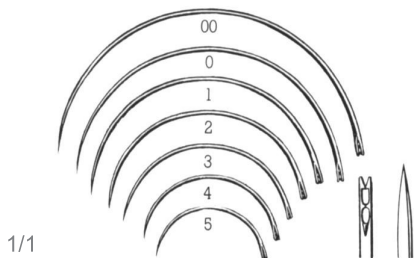

- Fig. 00 BX.175.20
- Fig. 0 BX.175.10
- Fig. 1 BX.176.01
- Fig. 2 BX.176.02
- Fig. 3 BX.176.03
- Fig. 4 BX.176.04
- Fig. 5 BX.176.05

**BX.175.10/20**  
**BX.176.01/05**

Pb  
Muscular and  
Skin Suture,  
Intestinal Suture

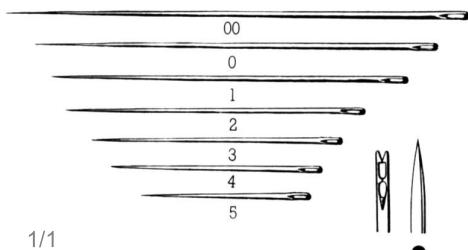

- Fig. 00 BX.182.20
- Fig. 0 BX.182.10
- Fig. 1 BX.183.01
- Fig. 2 BX.183.02
- Fig. 3 BX.183.03
- Fig. 4 BX.183.04
- Fig. 5 BX.183.05

**BX.182.10/20**  
**BX.183.01/05**

Pc  
Muscular and  
Skin Suture,  
Intestinal Suture



- Fig. 00 BX.187.20
- Fig. 0 BX.187.10
- Fig. 1 BX.188.01
- Fig. 2 BX.188.02
- Fig. 3 BX.188.03
- Fig. 4 BX.188.04
- Fig. 5 BX.188.05

**BX.187.10/20**  
**BX.188.01/05**

Pd  
Muscular and  
Skin Suture,  
Intestinal Suture

**BX**

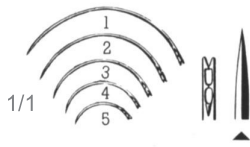

**BX.205.01/05**

Ob  
Muscular and  
Skin Suture

Fig. 1 BX.205.01  
Fig. 2 BX.205.02  
Fig. 3 BX.205.03  
Fig. 4 BX.205.04  
Fig. 5 BX.205.05

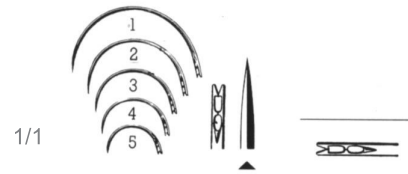

**BX.209.01/05**

Og  
Muscular and  
Skin Suture

Fig. 1 BX.209.01  
Fig. 2 BX.209.02  
Fig. 3 BX.209.03  
Fig. 4 BX.209.04  
Fig. 5 BX.209.05

Flat needles with lancet points at both sides only cutting, stainless, hand-honed, largest possible eye with double thread groove

**BX.217.04/39**

Castroviejo  
Muscular and  
Skin Suture



	5:1	Circle	Length of chord of the needle	Diameter of the needle
BX.217.04	3/8		4 mm	0,15 mm
BX.217.05	1/4		5 mm	0,15 mm
BX.217.10	1/4		5 mm	0,20 mm
BX.217.15	3/8		5 mm	0,20 mm
BX.217.20	1/4		5 mm	0,25 mm
BX.217.25	3/8		5 mm	0,25 mm
BX.217.30	1/2		5 mm	0,25 mm
BX.217.37	1/4		7 mm	0,35 mm *
BX.217.39	1/4		9 mm	0,35 mm *

\* Size of eye for + 4/0 suture material

### Vascular Suture Needles

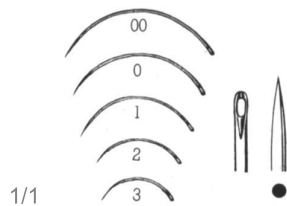

**BX.220.10/20**  
**BX.221.01/03**

Kalt  
Muscular and  
Skin Suture

Fig. 00 BX.220.10  
Fig. 0 BX.220.20  
Fig. 1 BX.221.01  
Fig. 2 BX.221.02  
Fig. 3 BX.221.03

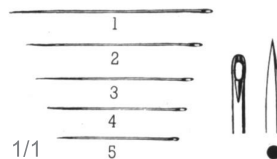

**BX.226.01/05**

Payr  
Muscular and  
Skin Suture

Fig. 1 BX.226.01  
Fig. 2 BX.226.02  
Fig. 3 BX.226.03  
Fig. 4 BX.226.04  
Fig. 5 BX.226.05

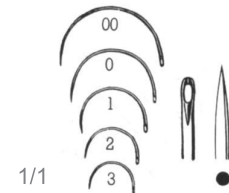

**BX.230.10/20**  
**BX.231.01/03**

Payr  
Muscular and  
Skin Suture

Fig. 00 BX.230.10  
Fig. 0 BX.230.20  
Fig. 1 BX.231.01  
Fig. 2 BX.231.02  
Fig. 3 BX.231.03

# Corneal Needles, fitted with sutures, sterile packed in transparent package

CORNEALNADELN, ARMIERT, STERIL, IN KLARSICHTPACKUNG - AGUJAS CORNEALES, ARMADAS, ESTÉRILES, EN EMBALAJES TRANSPARENTES

# Kolpen

SUTURE  
NAHT  
SUTURA

**BX**

**BX.240.01/03**  
**BX.241.01/03**  
**BX.242.01/05**  
**BX.243.01/05**  
**BX.244.01/02**  
**BX.245.01/02**

Corneal  
Needles

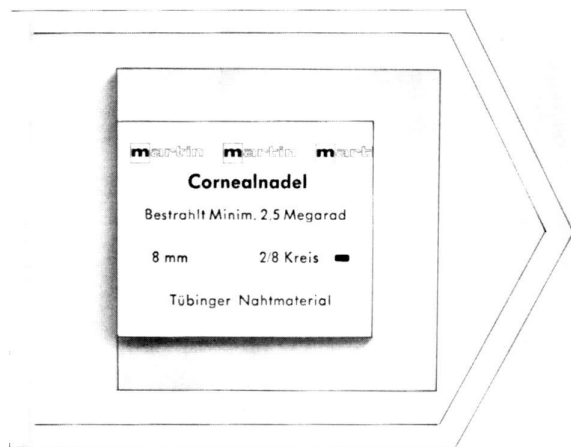

Flat needles with lancet points, cutting only at both sides, stainless, sterile, fitted with sterile non-absorbable suture material

Table for suture material

Gauge	Diameter in millimeters	
	EP 1	USP
0.1		11-0
0.2		10-0
0.3		9-0
0.4		8-0
0.5		7-0
0.7		6-0
1		5-0
		0,01-0,019
		0,02-0,029
		0,03-0,039
		0,04-0,049
		0,05-0,069
		0,07-0,09
		0,10-0,14

	Suture material	Gauge of the suture material	Length of chord of the needle	Circle	Diameter of needle
BX.240.01	Barraquer silk	USP 8-0	4 mm	3/8	0,15 mm
BX.241.01	Barraquer silk	USP 8-0	5 mm	1/4	0,15 mm
BX.242.01	Barraquer silk	USP 8-0	5 mm	3/8	0,20 mm
BX.243.01	Barraquer silk	USP 8-0	6 mm	1/4	0,20 mm
BX.244.01	Barraquer silk	USP 8-0	5 mm	3/8	0,25 mm
BX.245.01	Barraquer silk	USP 8-0	6 mm	1/4	0,25 mm
BX.240.02	Nylon Tubingen material	USP 10-0	4 mm	3/8	0,15 mm
BX.241.02	Nylon Tubingen material	USP 10-0	5 mm	1/4	0,15 mm
BX.242.02	Nylon Tubingen material	USP 10-0	5 mm	3/8	0,20 mm
BX.243.02	Nylon Tubingen material	USP 10-0	6 mm	1/4	0,20 mm
BX.240.03	Perlon-Supramid	USP 10-0	4 mm	3/8	0,15 mm
BX.241.03	Perlon-Supramid	USP 10-0	5 mm	1/4	0,15 mm
BX.242.03	Perlon-Supramid	USP 10-0	5 mm	3/8	0,20 mm
BX.242.04	Perlon-Supramid	USP 9-0	5 mm	3/8	0,20 mm
BX.242.05	Perlon-Supramid	USP 8-0	5 mm	3/8	0,20 mm
BX.243.03	Perlon-Supramid	USP 10-0	6 mm	1/4	0,20 mm
BX.243.04	Perlon-Supramid	USP 9-0	6 mm	1/4	0,20 mm
BX.243.05	Perlon-Supramid	USP 8-0	6 mm	1/4	0,20 mm
BX.244.02	Perlon-Supramid	USP 9-0	5 mm	3/8	0,25 mm
BX.245.02	Perlon-Supramid	USP 8-0	6 mm	1/4	0,25 mm

All needed sutures are sterile packed in transparent packages. They are sterilized in a Cobalt-60 plant with an intensity of at least 2,5 Megarad.

Designation of suture Material:

Barraquer silk blue twisted

Nylon Tubingen material black monofil

Perlon-Supramid black monofil

All sutures have a length of 30 cm (12")

**BX**



**BX.048.18**  
**BX.049.18**  
Micro-Needle  
Holders

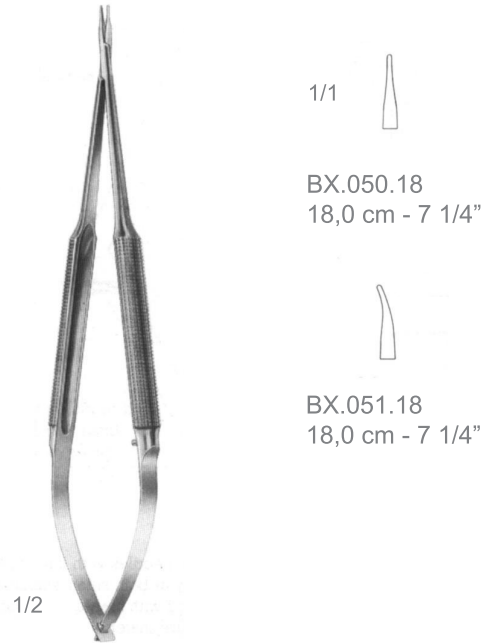

**BX.050.18**  
**BX.051.18**  
Micro-Needle  
Holders

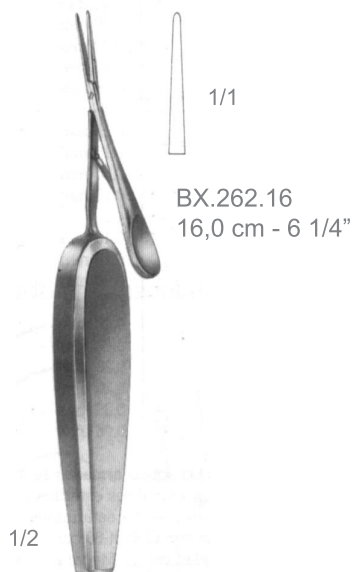

**BX.262.16**  
Barraquer  
Micro-Needle  
Holders

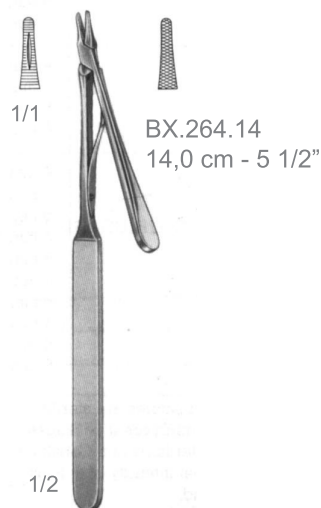

**BX.264.14**  
Barraquer  
Micro-Needle  
Holders



**BX.274.14**  
Kalt  
Micro-Needle  
Holders



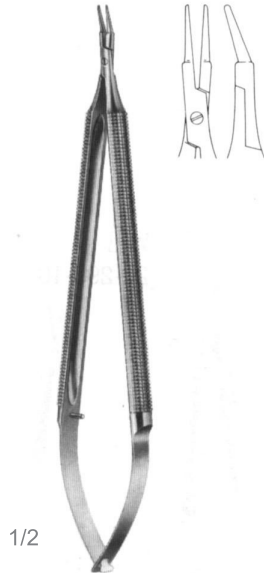

1/2

**BX.281.01/03**  
Gomel  
Micro-Needle  
Holders

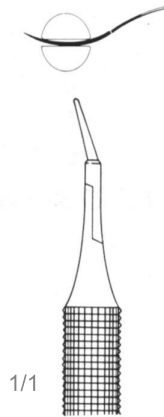

1/1

BX.281.01  
16,0 cm - 6 1/4"

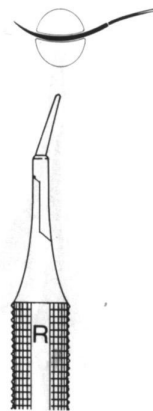

BX.281.02  
16,0 cm - 6 1/4"  
For right hander,  
concave/convex,  
inner jaws

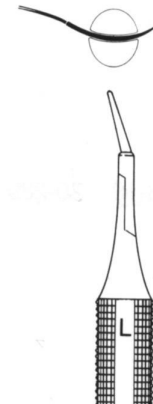

BX.281.03  
16,0 cm - 6 1/4"  
For left hander,  
concave/convex,  
inner jaws



1/2

**BX.285.14**  
**BX.287.14/15**  
Gomel  
Micro-Needle  
Holders

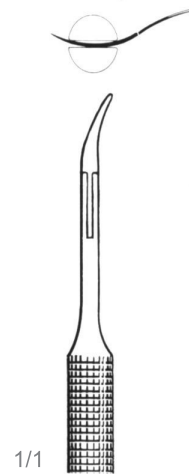

1/1

BX.285.14  
14,0 cm - 5 1/2"



BX.287.14  
14,0 cm - 5 1/2"  
For right hander,  
concave/convex,  
inner jaws

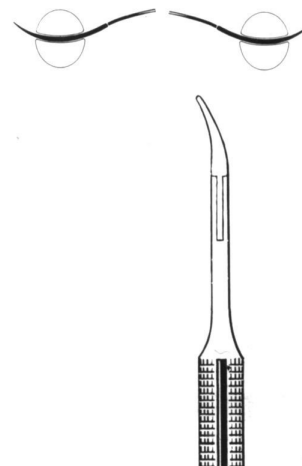

BX.287.15  
14,0 cm - 5 1/2"  
For left hander,  
concave/convex,  
inner jaws

**BX**

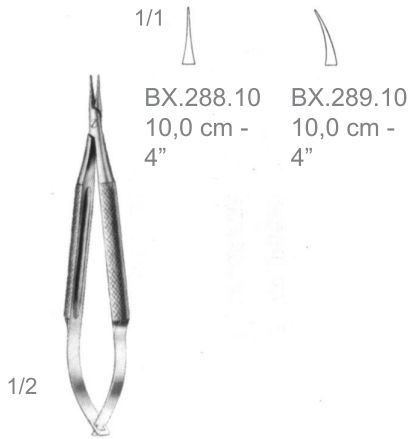

**BX.288.10**  
**BX.289.10**

Barraquer-Troutman  
Micro-Needle  
Holders

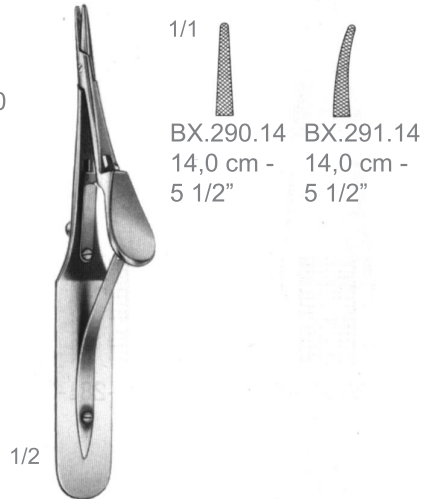

**BX.290.14**  
**BX.291.14**

Arruga  
Micro-Needle  
Holders

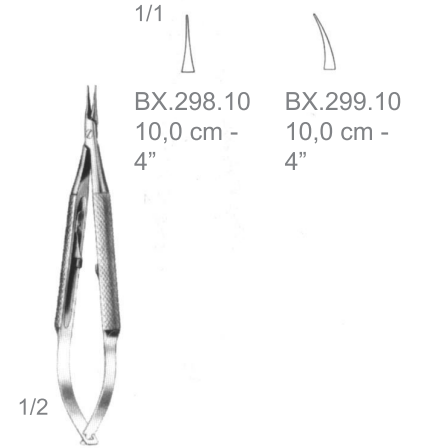

**BX.298.10**  
**BX.299.10**

Barraquer-Troutman  
Micro-Needle  
Holders



**BX.300.11**  
11,0 cm - 4"

BX.300.11  
Also available of Titan

**BX.300.13**  
13,0 cm - 5"

**BX.300.11/13**  
Barraquer  
Micro-Needle  
Holders

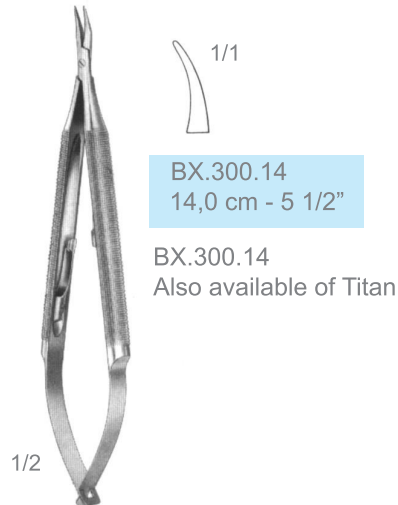

**BX.300.14**  
14,0 cm - 5 1/2"

BX.300.14  
Also available of Titan

**BX.300.14**  
Barraquer  
Micro-Needle  
Holders



**BX.301.13**  
13,0 cm - 5"

**BX.301.13**  
Micro-Needle  
Holders

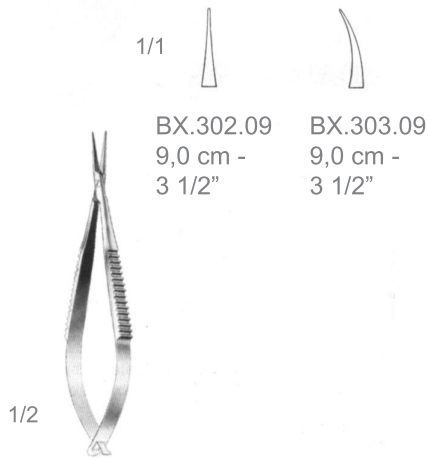

**BX.302.09**  
**BX.303.09**

Castroviejo  
Micro-Needle  
Holders

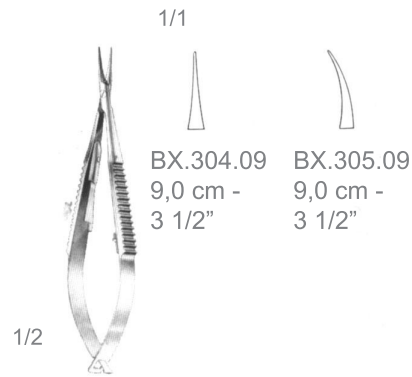

**BX.304.09**  
**BX.305.09**

Castroviejo  
Micro-Needle  
Holders

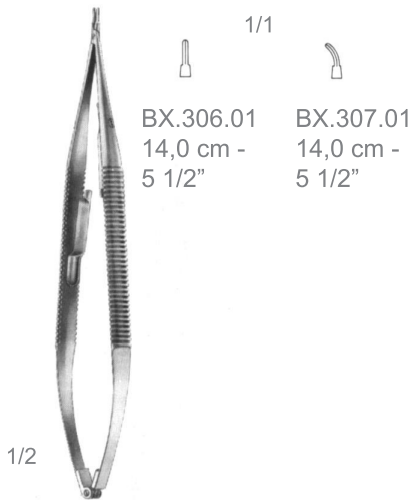

**BX.306.01**  
**BX.307.01**

Barraquer  
Micro-Needle  
Holders



**BX.306.14**  
14,0 cm -  
5 1/2"

**BX.307.14**  
14,0 cm -  
5 1/2"

BX.306.14  
BX.307.14  
Also available of Titan

**BX.306.14**  
**BX.307.14**

Castroviejo  
Micro-Needle  
Holders

**BX**

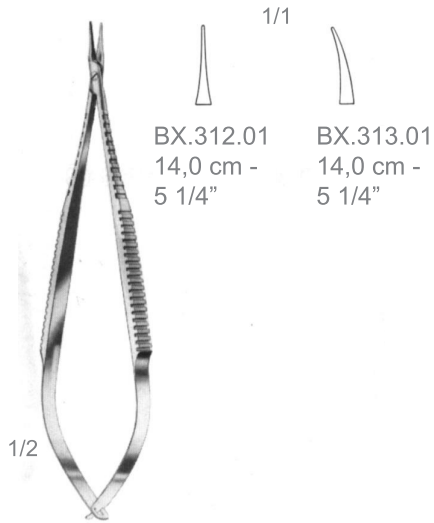

**BX.312.01**  
**BX.313.01**  
Castroviejo  
Micro-Needle  
Holders



**BX.312.14**  
**BX.313.14**  
Castroviejo  
Micro-Needle  
Holders

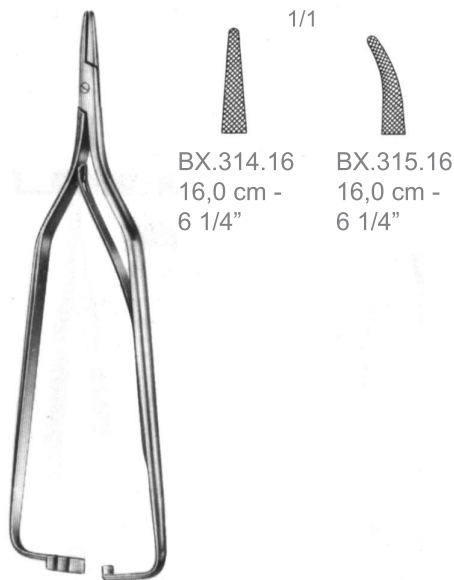

**BX.314.16**  
**BX.315.16**  
Arruga  
Micro-Needle  
Holders



**BX.316.13**  
Castroviejo  
Micro-Needle  
Holders



**BX.317.12**  
Castroviejo-Barraquer  
Micro-Needle  
Holders

Razor Blade Holders and Breakers

RASIERKLINGENHALTER UND -BRECHER - PINZAS PARA SUJETAR Y ROMPER HOJAS DE AFEITAR

SUTURE  
NAHT  
SUTURA



Breakable razor blade  
of stainless steel

**BX.320.00**  
Razor blade holders  
and breakers

BX.320.00  
Package of 10  
blades



BX.320.09  
9,0 cm - 3 1/2"  
Ø 5,5 mm



**BX.320.09**  
Troutman-Chris  
Razor blade holders  
and breakers



BX.320.13  
13,0 cm - 5 1/4"  
Ø 10 mm

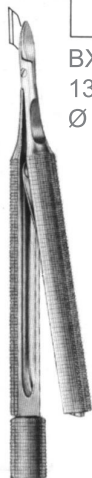

**BX.320.13**  
Castroviejo  
Razor blade holders  
and breakers



BX.324.13  
13,0 cm - 5 1/4"  
Ø 8 mm



**BX.324.13**  
Castroviejo  
Razor blade holders  
and breakers



BX.321.09  
9,0 cm - 3 1/2"  
Ø 5,5 mm



**BX.321.09**  
Troutman-Chris  
Razor blade holders  
and breakers

**BX**

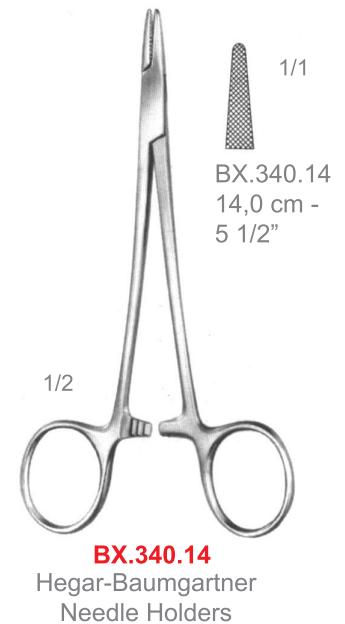
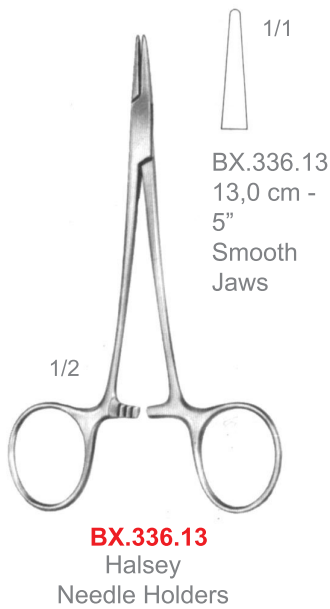
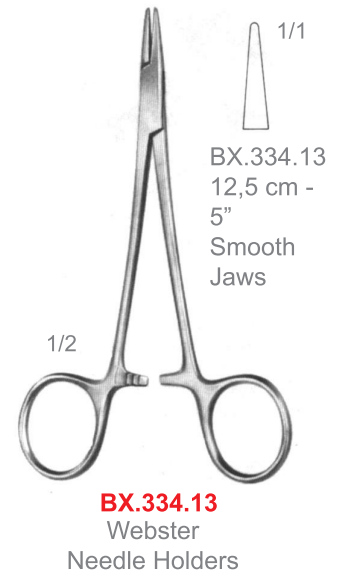
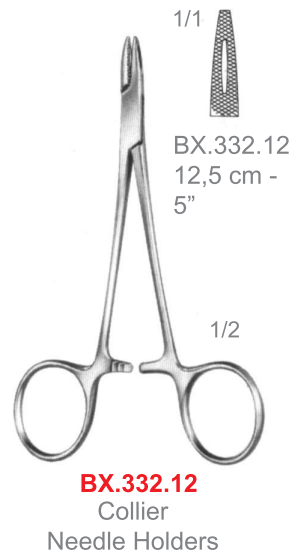
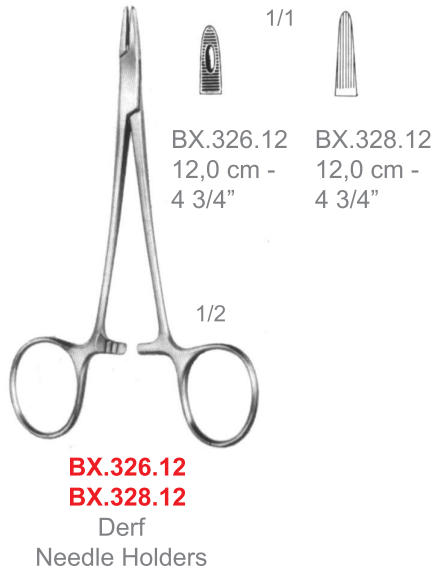

Needle holders

NADELHALTER - PORTA-AGUJAS

# Kolpen

SUTURE  
NAHT  
SUTURA

**BX**

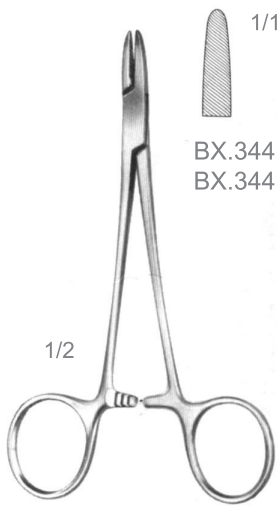

BX.344.13 13,0 cm - 5"  
BX.344.18 18,0 cm - 7"

**BX.344.13/18**  
Brown  
Needle Holders



BX.348.15  
15,0 cm - 6"

**BX.348.15**  
Crile-Murray  
Needle Holders



BX.350.15  
15,0 cm - 6"

**BX.350.15**  
Crile-Wood  
Needle Holders



BX.360.18  
18,0 cm - 7"

**BX.360.18**  
Adson  
Needle Holders



BX.364.18  
18,0 cm - 7"

**BX.364.18**  
Metzenbaum  
Needle Holders



BX.384.17  
17,0 cm -  
6 3/4"

**BX.384.17**  
M.G.H.  
(Mass-General-Hospital)  
Needle Holders

**BX**

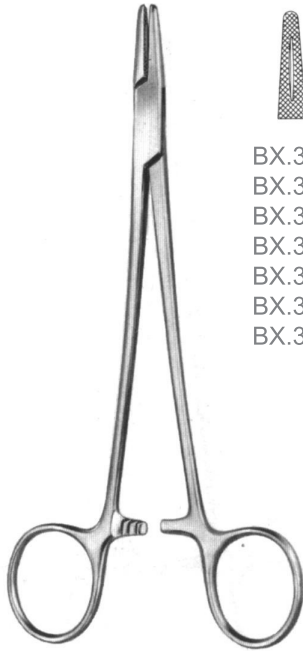

**BX.390.14/30**  
Mayo-Hegar  
Needle Holders



BX.390.14 14,0 cm - 5 1/2"  
BX.390.16 16,0 cm - 6 1/4"  
BX.390.18 18,0 cm - 7"  
BX.390.20 20,0 cm - 8"  
BX.390.24 24,0 cm - 9 1/2"  
BX.390.26 26,0 cm - 10 1/4"  
BX.390.30 30,0 cm - 12"

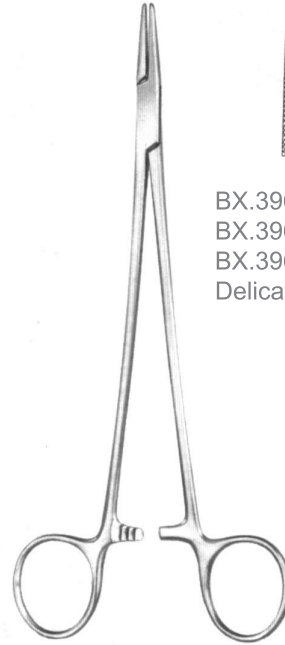

**BX.396.16/20**  
Mayo-I  
Needle I



BX.396.16 16,0 cm - 6 1/4"  
BX.396.18 18,0 cm - 7"  
BX.396.20 20,0 cm - 8"  
Delicate pattern

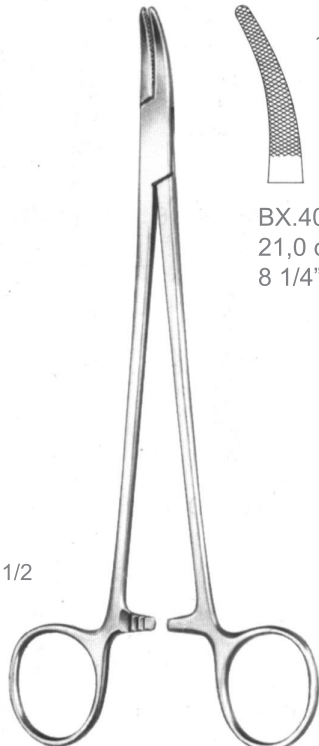

1/2

**BX.403.21**  
Heaney  
Needle Holders

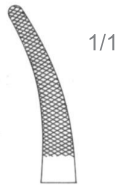

1/1

BX.403.21  
21,0 cm -  
8 1/4"

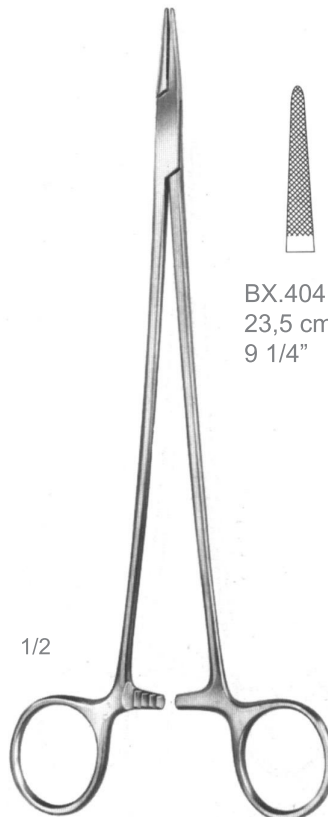

1/2

**BX.404.23**  
Jamison  
Needle Holders



1/1

BX.404.23  
23,5 cm -  
9 1/4"

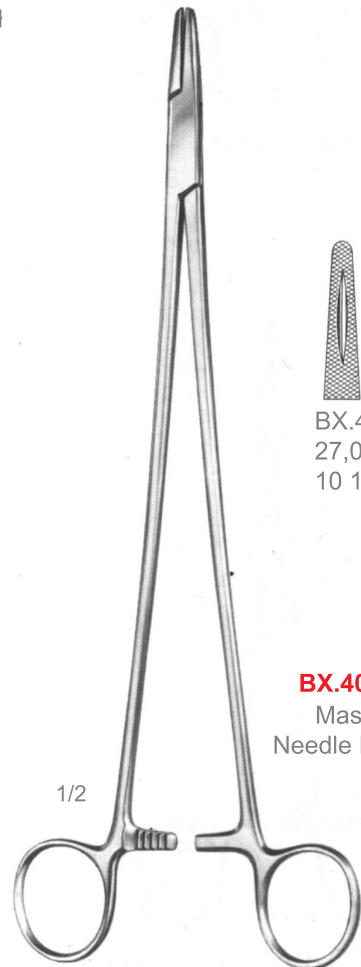

1/2

**BX.408.27**  
Masson  
Needle Holders



1/1

BX.408.27  
27,0 cm -  
10 1/2"



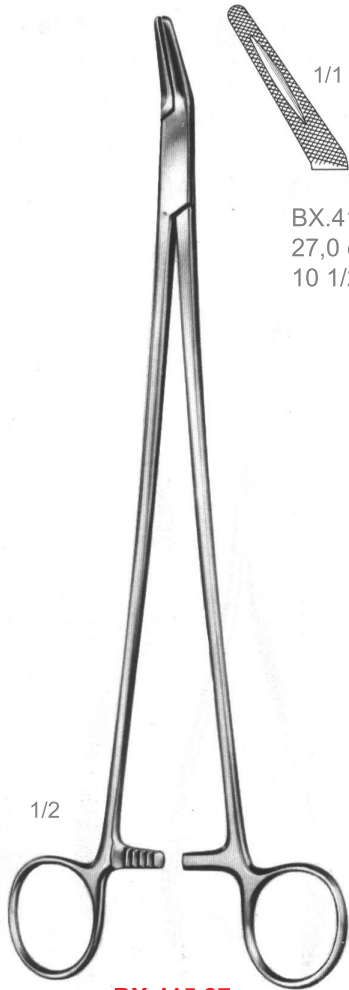

**BX.415.27**  
27,0 cm -  
10 1/2"

**BX.415.27**  
Finocchiato  
Needle Holders

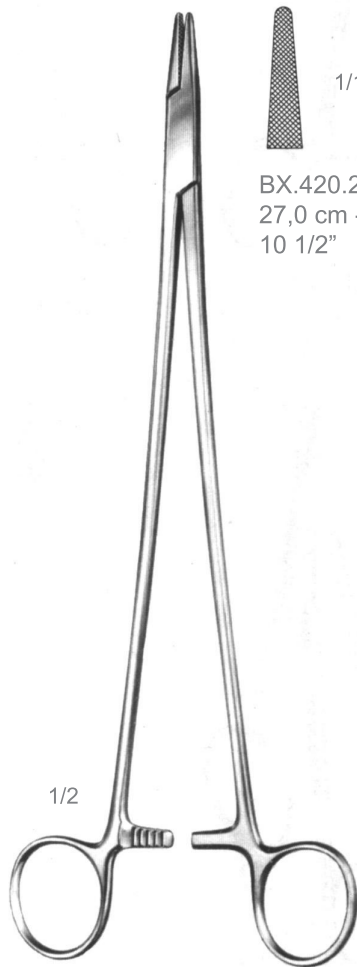

**BX.420.27**  
27,0 cm -  
10 1/2"

**BX.420.27**  
Wangenstein  
Needle Holders



**BX.437.27**  
27,0 cm -  
10 1/2"

**BX.437.27**  
Johnson  
Needle Holders

**BX**

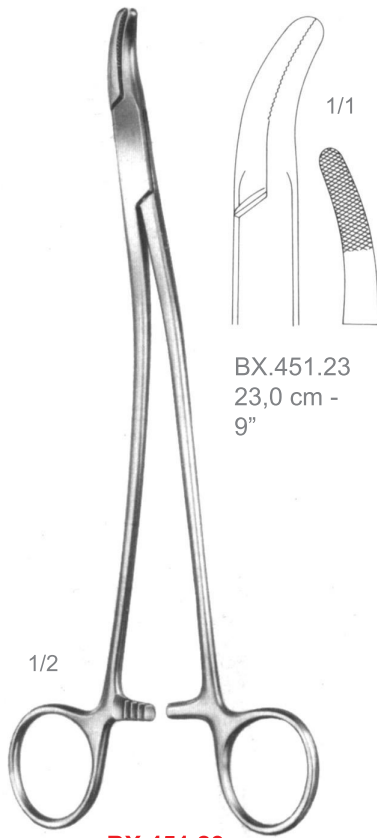

BX.451.23  
23,0 cm -  
9"

**BX.451.23**  
Stratte  
Needle Holders

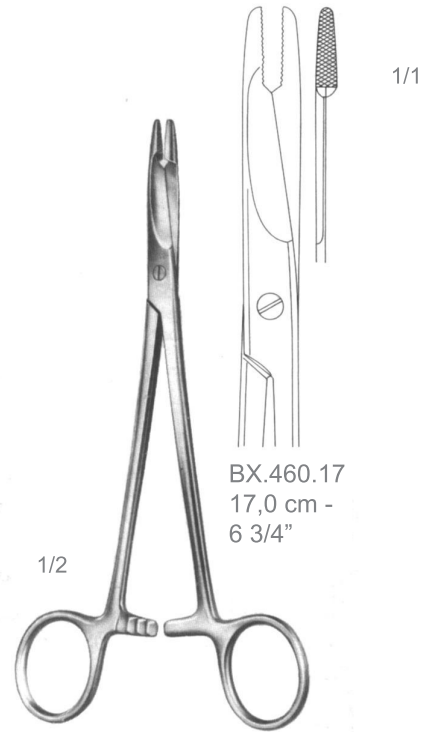

BX.460.17  
17,0 cm -  
6 3/4"

**BX.460.17**  
Olsen-Hegar  
Needle Holders



BX.464.14 14,0 cm - 5 1/2"  
BX.464.18 18,0 cm - 7"

**BX.464.14/18**  
Olsen-Hegar  
Needle Holders

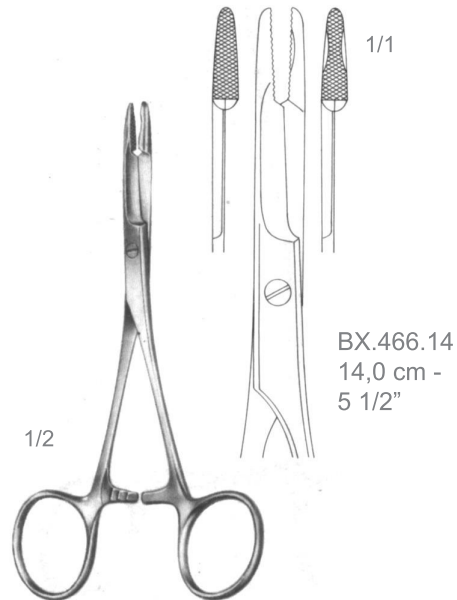

BX.466.14  
14,0 cm -  
5 1/2"

**BX.466.14**  
Olsen-Hegar  
Needle Holders

Muscular and Skin Suture, Intestinal Suture

CHIRURGISCHE NADELN - SUTURAS MUSCULARES, CUTÁNEAS E  
INTESTINALES

# Kolpen

SUTURE  
NAHT  
SUTURA

**BX**

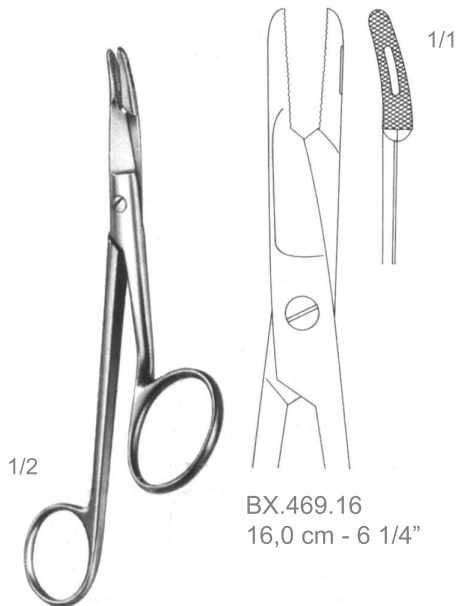

**BX.469.16**  
Olsen-Hegar  
Needle Holders



**BX.500.15**  
Crile  
Needle Holders

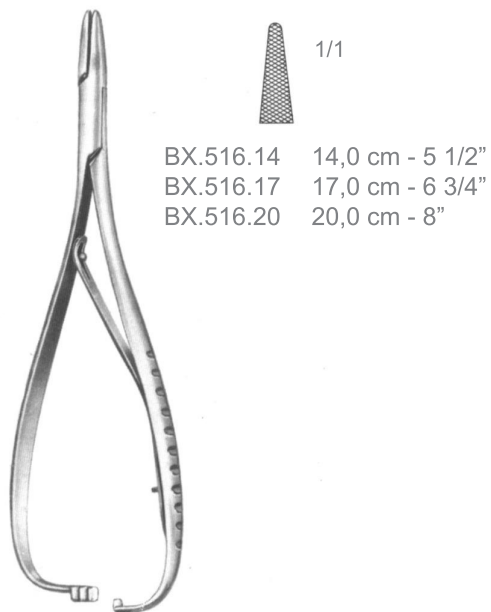

**BX.516.14/20**  
Mathieu  
Needle Holders



**BX.526.14/17**  
Mathieu  
Needle Holders

**BX**



**BX.536.17/20**  
Matthieu  
Needle Holders



**BX.574.18**  
Toennis  
Needle Holders



**BX.576.20**  
Lichtenberg  
Needle Holders

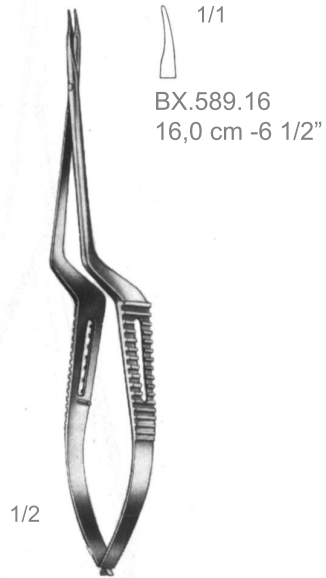

**BX.589.16**  
Micro-Needle  
Holders



**BX.592.23**  
**BX.593.23**  
**BX.595.19**  
Micro-Needle  
Holders

**BX**



**BX.600.22**  
Potts-Smith  
Needle Holders



**BX.602.18**  
Hepp-Scheidel  
Needle Holders

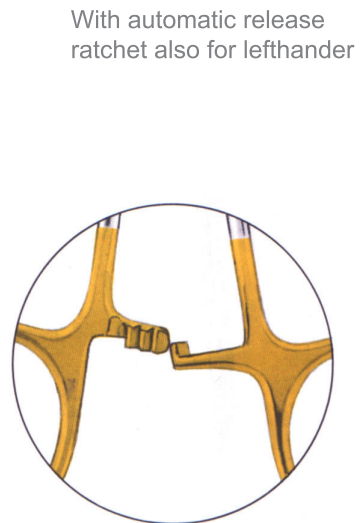

**BX.610.18**  
Jaboma-TC  
Needle Holders



**BX.604.13/15**  
Needle Holders

diamond-coated  
jaw, 2,0 mm wide



1/2

**BX.605.15/23**  
**BX.606.15/23**  
**BX.607.15/23**  
**BX.608.15/23**

Micro Needle  
Holders

*Safety Wave*



diamantiert  
diamond coated  
diamantados  
diamantate

4-0 6-0



1/1



BX.606.15  
15,0 cm - 6"  
Steel

BX.605.15  
15,0 cm - 6"  
Steel

BX.608.15  
15,0 cm - 6"  
Steel

BX.607.15  
15,0 cm - 6"  
Steel

BX.606.18  
18,0 cm - 7"  
Steel

BX.605.18  
18,0 cm - 7"  
Steel

BX.608.18  
18,0 cm - 7"  
Steel

BX.607.18  
18,0 cm - 7"  
Steel

BX.606.21  
21,0 cm - 8 1/4"  
Steel

BX.605.21  
21,0 cm - 8 1/4"  
Steel

BX.608.21  
21,0 cm - 8 1/4"  
Steel

BX.607.21  
21,0 cm - 8 1/4"  
Steel

BX.606.23  
23,0 cm - 9"  
Steel

BX.605.23  
23,0 cm - 9"  
Steel

BX.608.23  
23,0 cm - 9"  
Steel

BX.607.23  
23,0 cm - 9"  
Steel

with lock

with lock

without lock

without lock

diamond-coated  
jaw, 2,0 mm wide



1/2

1/1



BX.612.18 18,0 cm - 6"  
Steel  
BX.612.21 21,0 cm - 7"  
Steel

with lock, double action

4-0 6-0



**BX.612.18/21**  
Micro Needle  
Holders

**BX**



**BX.620.14/21**  
**BX.621.14/21**

Castroviejo  
Needle Holders



BX.620.14 14,0 cm - 5 1/2"  
Smooth

BX.620.18 18,0 cm - 7"  
Micro profile

BX.620.21 21,0 cm - 8 1/2"  
Micro profile



BX.621.14 14,0 cm  
Smooth

BX.621.18 18,0 cm - 7"  
Micro profile

BX.621.21 21,0 cm - 8 1/2"  
Micro profile



BX.620.00  
14,5 cm - 5 3/4"  
with lock  
micro profile



BX.620.01  
14,5 cm - 5 3/4"  
with lock  
micro profile



1/1  
BX.626.13  
13,0 cm - 5"  
Smooth



**BX.626.13**  
Barraquer  
Needle Holders



**BX.622.16**  
**BX.623.16**  
Arruga  
Needle Holders

1/1



BX.622.16  
16,0 cm - 6 1/4"  
Mini Profile



BX.623.16  
16,0 cm - 6 1/4"  
Mini Profile



1/1  
BX.624.13  
13,0 cm - 5"  
Smooth



**BX.624.13**  
Castroviejo  
Needle Holders



1/1  
BX.628.13  
13,0 cm - 5"  
Smooth



**BX.628.13**  
Barraquer  
Needle Holders





BX.630.13  
13,0 cm -  
5"  
Smooth

**BX.630.13**  
Webster  
Needle Holders



BX.632.12  
12,0 cm -  
4 3/4"  
Mini Profile

**BX.632.12**  
Derf  
Needle Holders



BX.634.13  
13,0 cm - 5"  
Mini Profile

BX.634.14  
14,0 cm - 5 1/2"

**BX.634.13/14**  
Hegar-Baumgartner  
Needle Holders



BX.636.13  
13,0 cm -  
5"  
Smooth

BX.637.13  
13,0 cm -  
5"  
Mini profile

**BX.636.13**  
**BX.637.13**  
Halsey  
Needle Holders



BX.637.12  
12,0 cm -  
4 3/4"  
Smooth

**BX.637.12**  
Webster  
Needle Holders



BX.638.15  
15,0 cm -  
6"  
Mini profile

**BX.638.15**  
Crile-Wood  
Needle Holders

**BX**

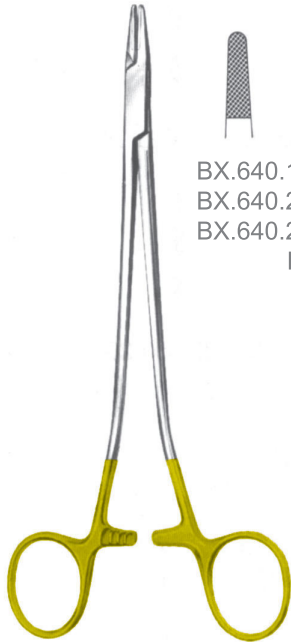

BX.640.18 18,0 cm - 7"  
BX.640.20 20,0 cm - 8"  
BX.640.26 26,0 cm - 10 1/4"  
Normal profile

**BX.640.18/26**  
Sarot  
Needle Holders

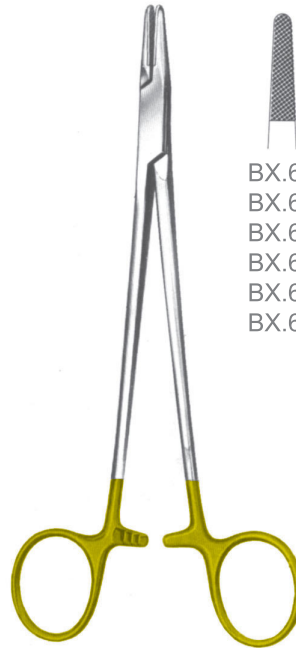

BX.642.16 16,0 cm - 6 1/4"  
BX.642.18 18,0 cm - 7"  
BX.642.20 20,0 cm - 8"  
BX.642.24 24,0 cm - 9 1/2"  
BX.642.26 26,0 cm - 10 1/4"  
BX.642.30 30,0 cm - 12"  
Normal profile

**BX.642.16/30**  
Mayo-Hegar  
Needle Holders

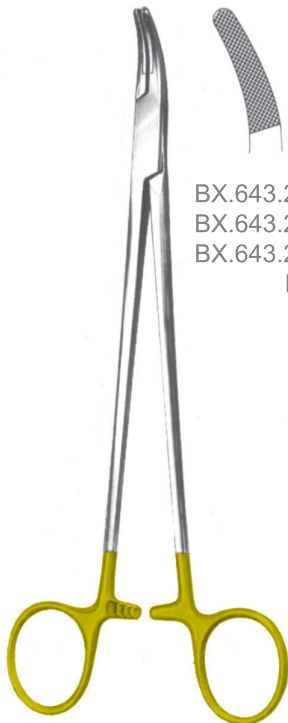

BX.643.20 20,0 cm - 8"  
BX.643.24 24,0 cm - 9 1/2"  
BX.643.26 26,0 cm - 10 1/4"  
Normal profile

**BX.643.20/26**  
Mayo-Hegar  
(Heaney)  
Needle Holders

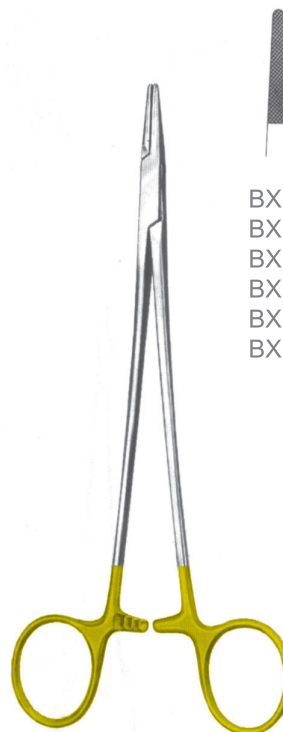

BX.646.18 18,0 cm - 7"  
BX.646.20 20,0 cm - 8"  
BX.646.23 23,0 cm - 9"  
BX.646.26 26,0 cm - 10 1/4"  
BX.646.31 31,0 cm - 12 1/4"  
BX.646.37 37,0 cm - 14 1/2"  
Normal profile

**BX.646.18/37**  
De Bakey  
Needle Holders

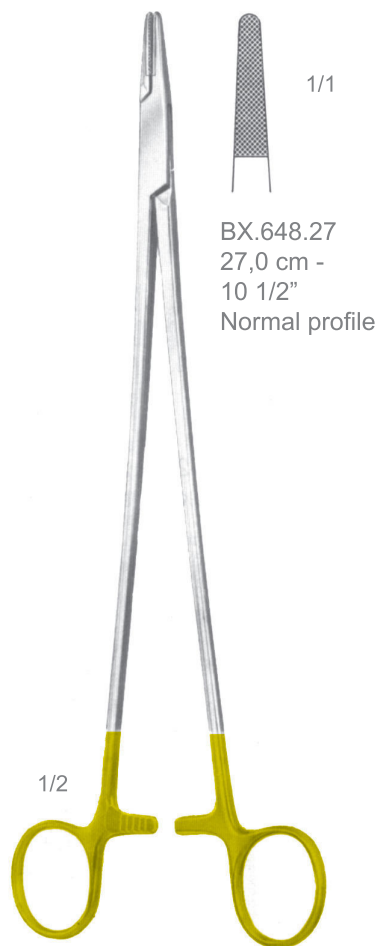

**BX.648.27**  
27,0 cm -  
10 1/2"  
Normal profile

**BX.648.27**  
Masson  
Needle Holders

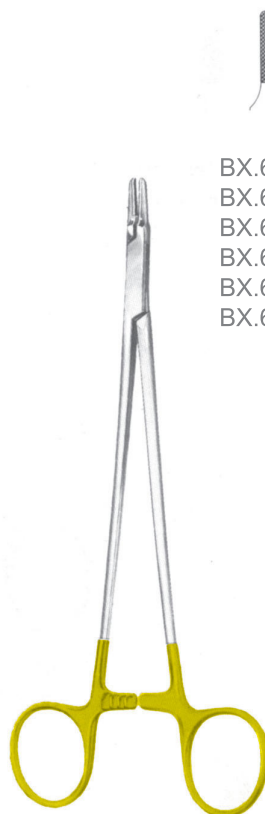

**BX.650.13** 13,0 cm - 5"  
**BX.650.15** 15,0 cm - 6"  
**BX.650.18** 18,0 cm - 7"  
**BX.650.20** 20,0 cm - 8"  
**BX.650.23** 23,0 cm - 9"  
**BX.650.26** 26,0 cm - 10 1/4"  
Mini profile

**BX.650.13/26**  
Ryder (Martin)  
Needle Holders



**BX.652.15** 15,0 cm - 6"  
**BX.652.17** 17,0 cm - 6 3/4"  
**BX.652.20** 20,0 cm - 8"  
Mini profile

**BX.652.15/20**  
Martin  
Needle Holders

**BX**

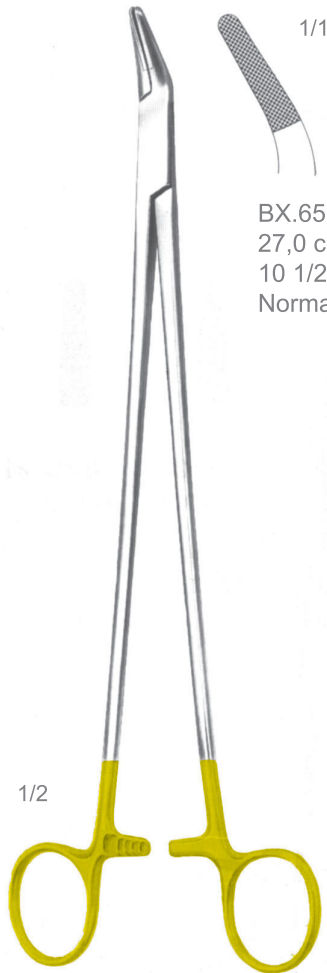

1/2

BX.653.27  
27,0 cm -  
10 1/2"  
Normal profile

**BX.653.27**  
Finocchetto  
Needle Holders



BX.654.13 13,0 cm - 5"  
BX.654.15 15,0 cm - 6"  
BX.654.18 18,0 cm - 7"  
BX.654.20 20,0 cm - 8"  
BX.654.23 23,0 cm - 9"  
BX.654.26 26,0 cm - 10 1/4"  
Micro profile

**BX.654.13/26**  
Ryder-Vascular  
Needle Holders

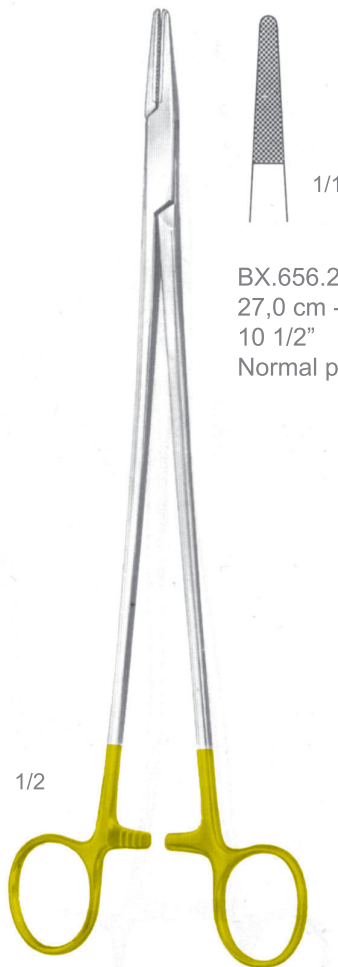

1/2

BX.656.27  
27,0 cm -  
10 1/2"  
Normal profile

**BX.656.27**  
Wangenstein  
Needle Holders

Needle Holders

NADELHALTER - PORTA-AGUJAS

# Kolpen

SUTURE  
NAHT  
SUTURA

**BX**

These needle-holders with extremely delicate jaws meet with the particular conditions in vascular surgery



- BX.658.14 14,0 cm - 5 1/2"
  - BX.658.18 18,0 cm - 7"
  - BX.658.20 20,0 cm - 8"
  - BX.658.26 23,0 cm - 9"
- Micro profile

**BX.658.14/23**  
Hegar-Vascular  
Needle Holders

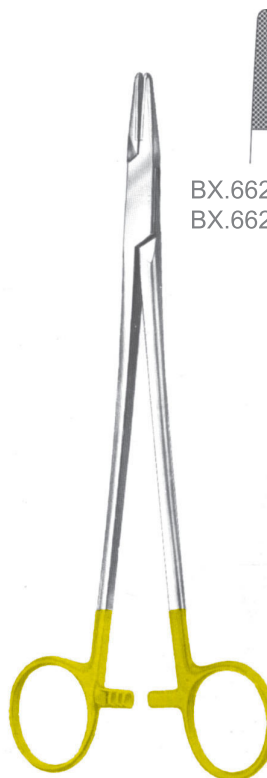

- BX.662.20 20,0 cm - 8"
  - BX.662.24 24,0 cm - 9 1/2"
- Normal profile

**BX.662.20/24**  
Hegar  
Needle Holders



- BX.659.20 20,0 cm - 8"
  - BX.659.24 24,0 cm - 9 1/2"
  - BX.659.26 26,0 cm - 10 1/4"
- Normal profile

**BX.659.20/26**  
Bozemann  
Needle Holders



- BX.660.00 14,0 cm - 5 1/2"
  - BX.666.02 18,0 cm - 7"
- Micro profile

BX.666.03  
20,0 cm - 8"

BX.666.04  
23,0 cm - 11 1/4"

**BX.660.00**  
**BX.666.02/04**  
Microvascular  
Needle Holders

**BX**



BX.665.22 22,0 cm - 8 1/2"  
 BX.665.23 23,0 cm - 9"  
 Normal profile

**BX.665.22/23**  
 Stratte  
 Needle Holders



BX.672.14  
 14,0 cm - 5 1/2"  
 BX.672.17  
 16,5 cm - 6 1/2"  
 BX.672.18  
 18,0 cm - 7"  
 Normal profile

**BX.672.14/18**  
 Olsen-Hegar  
 Needle Holders



BX.670.00  
 14,0 cm - 5 1/2"  
 BX.670.01  
 16,0 cm - 6 1/4"  
 BX.670.02  
 18,0 cm - 7"  
 BX.670.03  
 20,0 cm - 8"  
 Micro Profile

**BX.670.00/03**  
 Martini  
 Needle Holders



BX.673.15  
 15,0 cm - 6"  
 Mini profile

**BX.673.15**  
 Gillies-Mini  
 Needle Holders

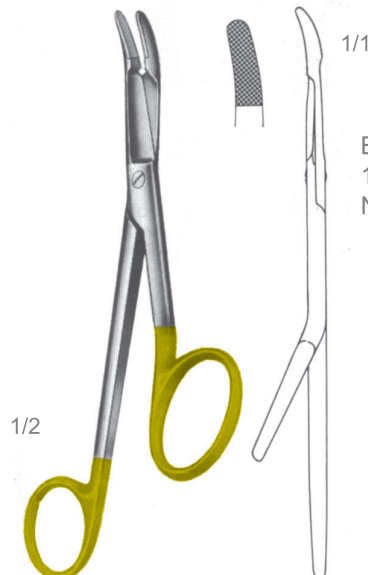

BX.673.16  
 16,0 cm - 6 1/4"  
 Normal profile

**BX.673.16**  
 Gillies  
 Needle Holders



BX.674.14 14,0 cm - 5 1/2"  
 BX.674.17 17,0 cm - 6 1/2"  
 BX.674.20 20,0 cm - 8"  
 Normal profile

**BX.674.14/20**  
 Mathieu-Kocher  
 Needle Holders

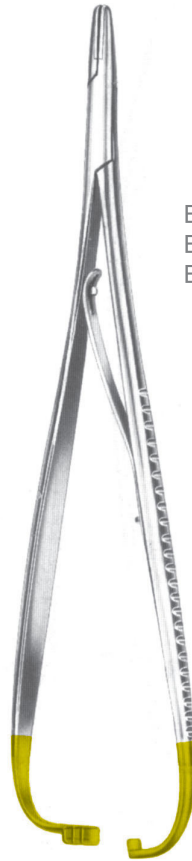

BX.676.14 14,0 cm - 5 1/2"  
 BX.676.17 17,0 cm - 6 1/2"  
 BX.676.20 20,0 cm - 8"  
 Normal profile

**BX.676.14/20**  
 Mathieu  
 Needle Holders



BX.668.00 14,0 cm - 5 1/2"  
 BX.668.01 16,0 cm - 6 1/4"  
 BX.668.02 18,0 cm - 7"  
 BX.668.03 20,0 cm - 8"  
 Smooth

**BX.668.00/03**  
 Martini  
 Needle Holders

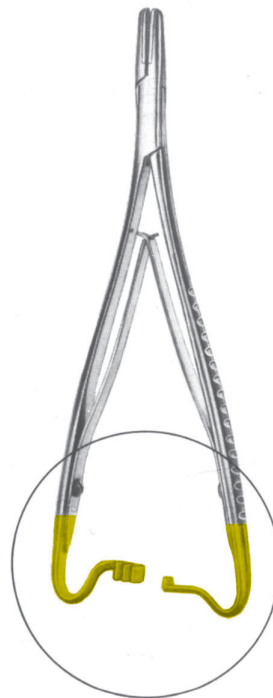

BX.678.17 17,0 cm - 6 1/2"  
 BX.678.20 20,0 cm - 8"  
 BX.678.23 23,0 cm - 9"  
 Normal profile

**BX.678.17/23**  
 Mathieu  
 Needle Holders

**BX**



BX.684.18 18,0 cm - 7"  
Normal profile

**BX.684.18**  
Toennis  
Needle Holders



BX.686.20 20,0 cm - 8"  
Normal profile

**BX.686.20**  
Lichtenberg  
Needle Holders



BX.692.18 18,0 cm - 7"  
BX.692.20 20,0 cm - 8"  
BX.692.23 23,0 cm - 9"  
Normal profile

**BX.692.18/23**  
Langenbeck  
Needle Holders



BX.696.20 20,0 cm - 8"  
BX.696.23 23,0 cm - 9"  
Normal profile

**BX.696.20/23**  
Zweifel  
Needle Holders





1/1



1



2



3



4

BX.702.15

BX.703.15

BX.704.15

14,0 cm - 5 1/2"

14,0 cm - 5 1/2"

14,0 cm - 5 1/2"

**BX.701.15**  
**BX.702.15**  
**BX.703.15**  
**BX.704.15**

Reverdin  
Reverdin Needles



1/1



1



2



3



4

BX.721.19

BX.722.19

BX.723.19

BX.724.19

19,5 cm - 7 3/4"

19,5 cm - 7 3/4"

19,5 cm - 7 3/4"

19,5 cm - 7 3/4"

BX.741.23

BX.742.23

BX.743.23

BX.744.23

22,5 cm - 8 3/4"

22,5 cm - 8 3/4"

22,5 cm - 8 3/4"

22,5 cm - 8 3/4"

1/2



**BX.741.23**  
**BX.742.23**  
**BX.743.23**  
**BX.744.23**

Reverdin  
Reverdin Needles

**BX.721.19**  
**BX.722.19**  
**BX.723.19**  
**BX.724.19**

Reverdin  
Reverdin Needles

**BX**

BX.775.25  
For deep sutures,  
with 1 needle  
BX.776.01



1/2

**BX.775.25**  
**BX.776.01/03**  
Young  
Suture Instruments  
Ligature Needles



BX.776.01  
Spare Needles for  
BX.775.25, only



BX.776.02  
Spare Needles for  
BX.775.25, only

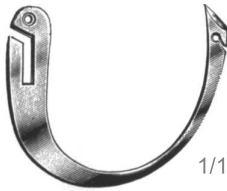

1/1

BX.776.01  
Spare Needles for  
BX.775.25, only

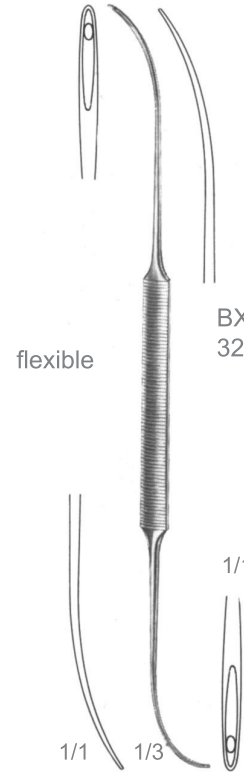

flexible

BX.813.32  
32,0 cm - 12 1/2"

1/1

**BX.813.32**

Schmeden-Dick  
Suture Instruments  
Ligature Needles

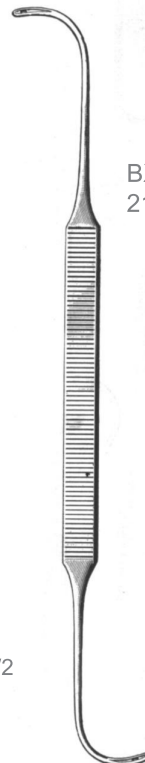

1/2

BX.815.21  
21,0 cm - 8 1/4"

**BX.815.21**  
Schmeden  
Suture Instruments  
Ligature Needles

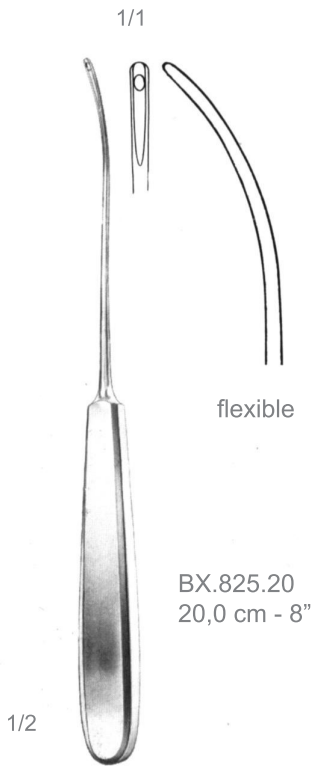

**BX.825.20**  
Ligature Needles

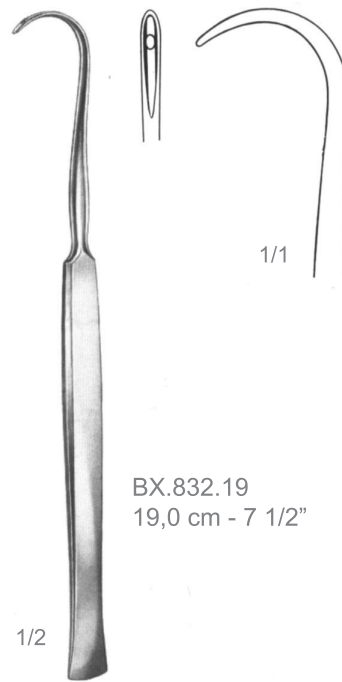

**BX.832.19**  
Cooper  
Ligature Needles

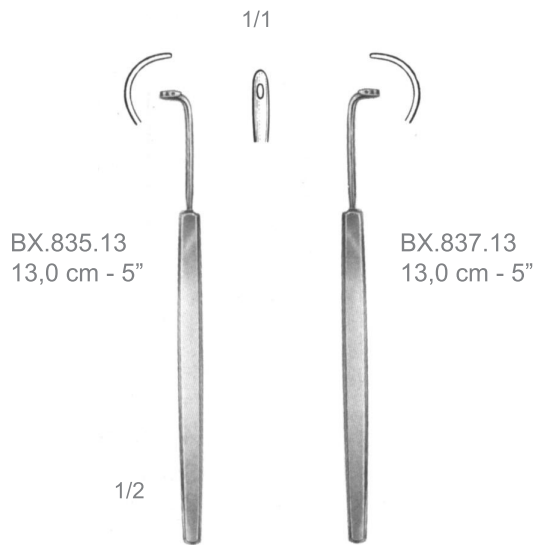

**BX.835.13**  
Kronecker  
Ligature Needles

**BX.837.13**  
Kronecker  
Ligature Needles

**BX**

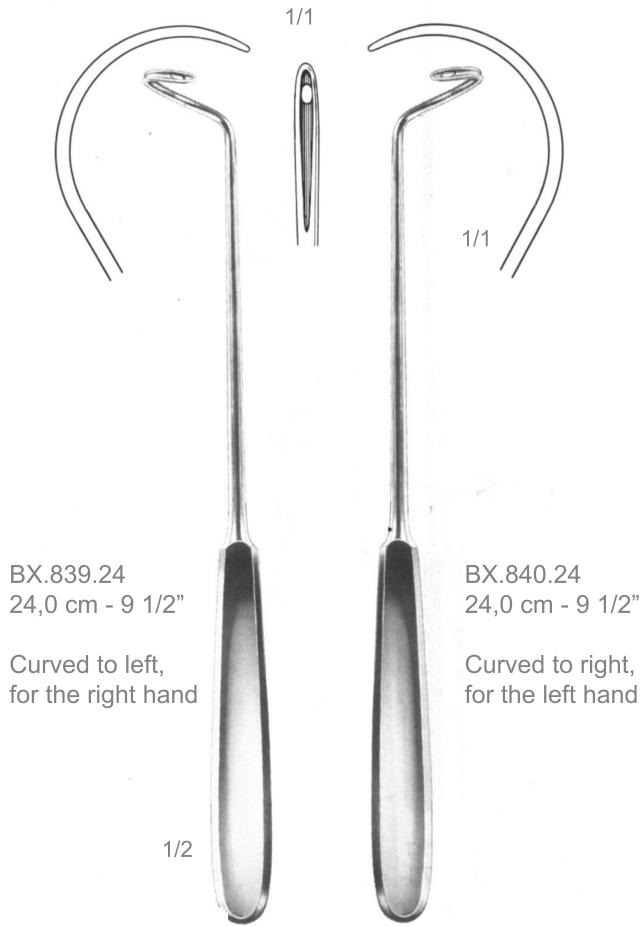

**BX.839.24**  
24,0 cm - 9 1/2"

Curved to left,  
for the right hand

1/2

**BX.839.24**  
Deschamps  
Ligature Needles

**BX.840.24**  
24,0 cm - 9 1/2"

Curved to right,  
for the left hand

1/1

**BX.840.24**  
Deschamps  
Ligature Needles

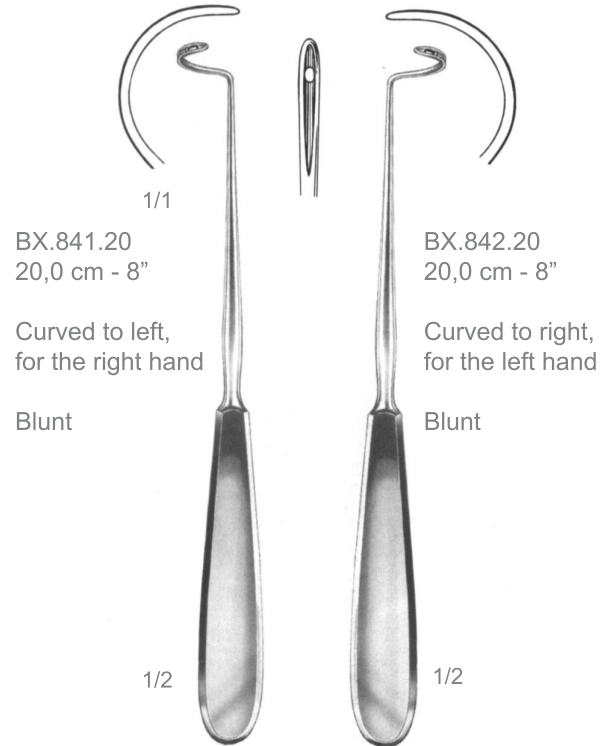

**BX.841.20**  
20,0 cm - 8"

Curved to left,  
for the right hand

Blunt

1/1

1/2

**BX.841.20**  
Deschamps  
Ligature Needles

**BX.842.20**  
20,0 cm - 8"

Curved to right,  
for the left hand

Blunt

1/2

**BX.842.20**  
Deschamps  
Ligature Needles

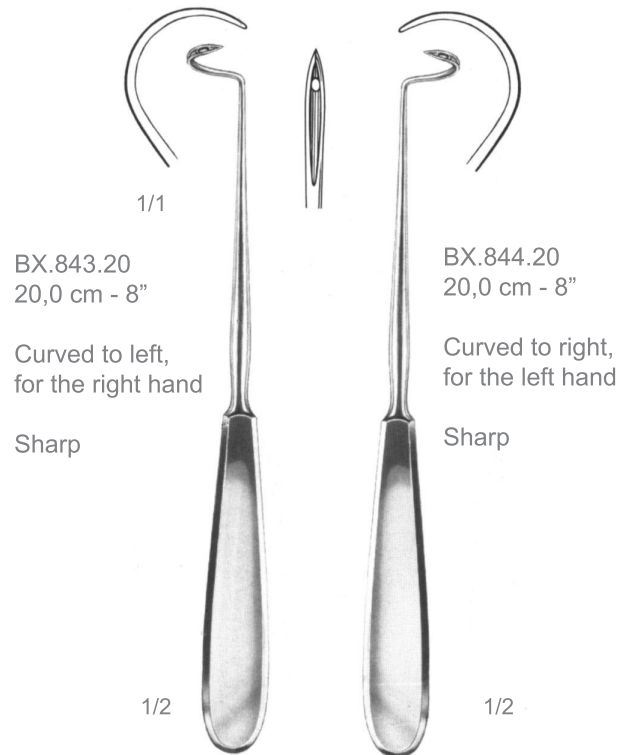

**BX.843.20**  
20,0 cm - 8"

Curved to left,  
for the right hand

Sharp

1/1

1/2

**BX.843.20**  
Deschamps  
Ligature Needles

**BX.844.20**  
20,0 cm - 8"

Curved to right,  
for the left hand

Sharp

1/2

**BX.844.20**  
Deschamps  
Ligature Needles

Ligature Needles

UNTERBINDUNGSNADELN - AGUJAS PARA LIGADURAS

# Kolpen

SUTURE  
NAHT  
SUTURA

**BX**

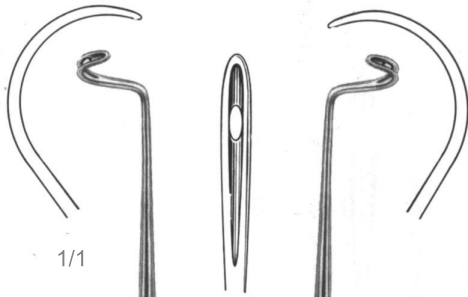

BX.845.21  
21,0 cm - 8 1/4"

Curved to left,  
for the right hand

Blunt

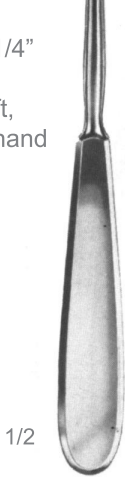

1/2

**BX.845.21**  
Deschamps  
Ligature Needles

BX.846.21  
21,0 cm - 8 1/4"

Curved to right,  
for the left hand

Blunt

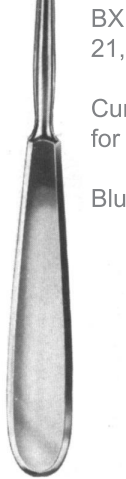

**BX.846.21**  
Deschamps  
Ligature Needles

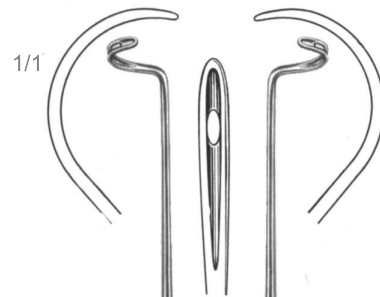

BX.849.27  
27,0 cm - 10 1/2"

Curved to left,  
for the right hand

Blunt



1/2

**BX.849.27**  
Deschamps  
Ligature Needles

BX.850.27  
27,0 cm - 10 1/2"

Curved to right,  
for the left hand

Blunt



**BX.850.27**  
Deschamps  
Ligature Needles

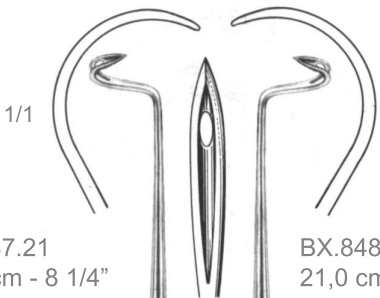

BX.847.21  
21,0 cm - 8 1/4"

Curved to left,  
for the right hand

Sharp

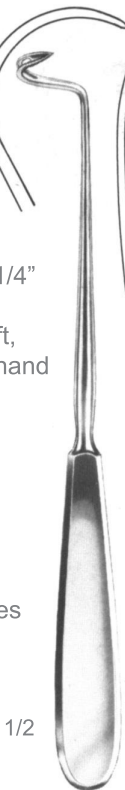

1/2

**BX.847.21**  
Deschamps  
Ligature Needles

BX.848.21  
21,0 cm - 8 1/4"

Curved to right,  
for the left hand

Sharp

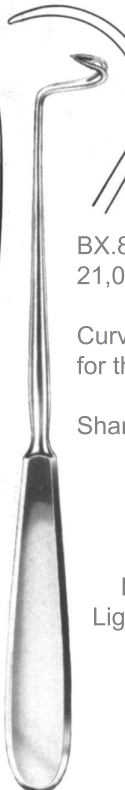

**BX.848.21**  
Deschamps  
Ligature Needles

**BX**

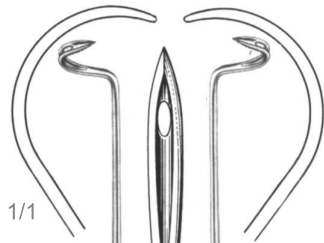

**BX.851.27**  
27,0 cm - 10 1/2"

Curved to left,  
for the right hand

Sharp

**BX.852.27**  
27,0 cm - 10 1/2"

Curved to right,  
for the left hand

Sharp

1/2

**BX.851.27**  
Deschamps  
Ligature Needles

**BX.852.27**  
Deschamps  
Ligature Needles

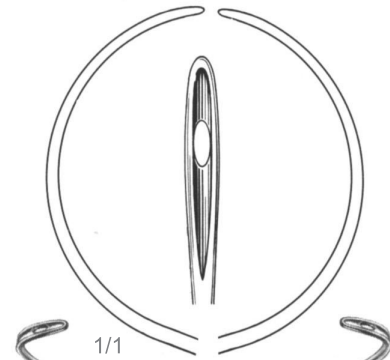

**BX.853.28**  
28,0 cm - 11"

Curved to left,  
for the right hand

Blunt

**BX.854.28**  
28,0 cm - 11"

Curved to right,  
for the left hand

Blunt

1/2

**BX.853.28**  
Deschamps  
Ligature Needles

**BX.854.28**  
Deschamps  
Ligature Needles

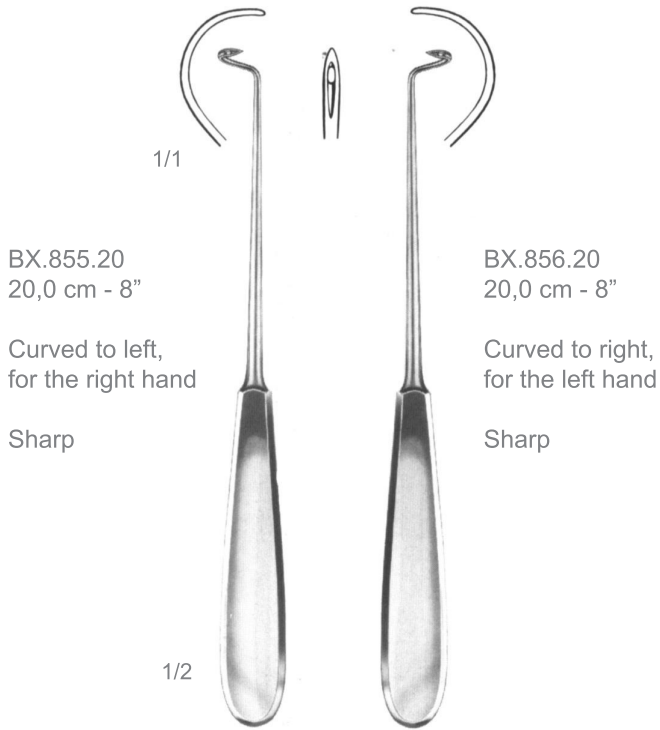

BX.855.20  
20,0 cm - 8"

Curved to left,  
for the right hand

Sharp

BX.856.20  
20,0 cm - 8"

Curved to right,  
for the left hand

Sharp

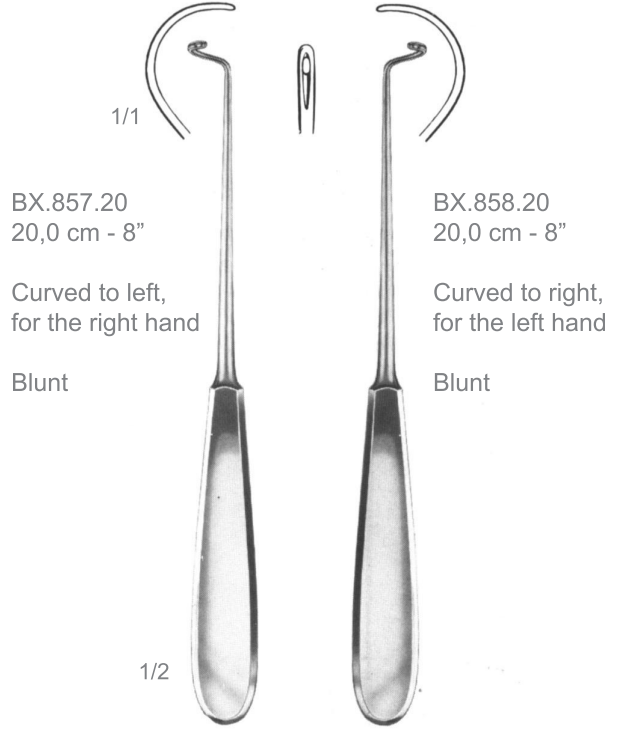

BX.857.20  
20,0 cm - 8"

Curved to left,  
for the right hand

Blunt

BX.858.20  
20,0 cm - 8"

Curved to right,  
for the left hand

Blunt

**BX.855.20**  
Ligature Needles

**BX.856.20**  
Ligature Needles

**BX.857.20**  
Ligature Needles

**BX.858.20**  
Ligature Needles

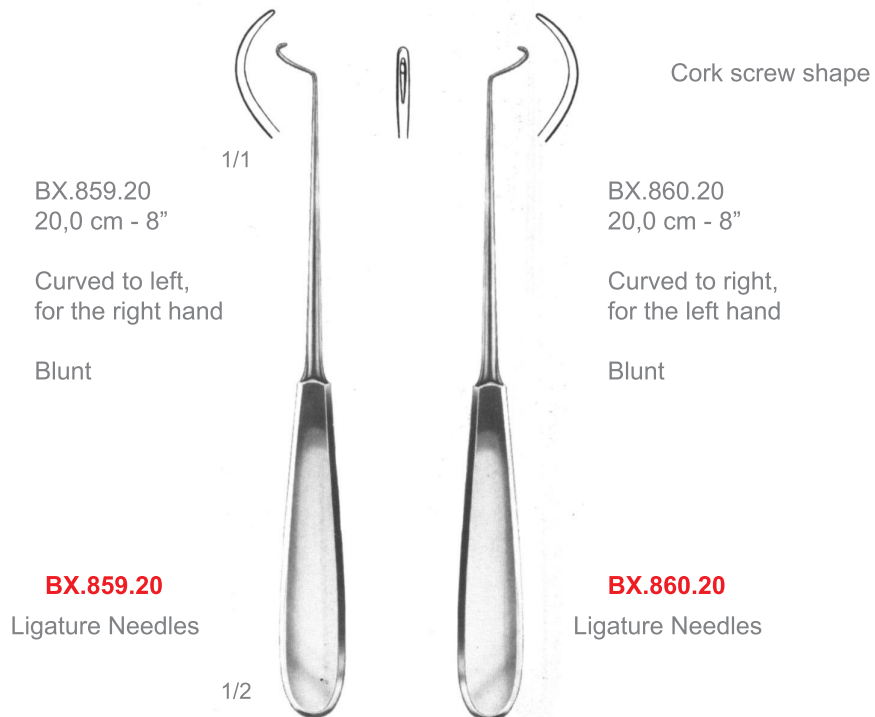

BX.859.20  
20,0 cm - 8"

Curved to left,  
for the right hand

Blunt

BX.860.20  
20,0 cm - 8"

Curved to right,  
for the left hand

Blunt

Cork screw shape

**BX.859.20**  
Ligature Needles

**BX.860.20**  
Ligature Needles

**BX**

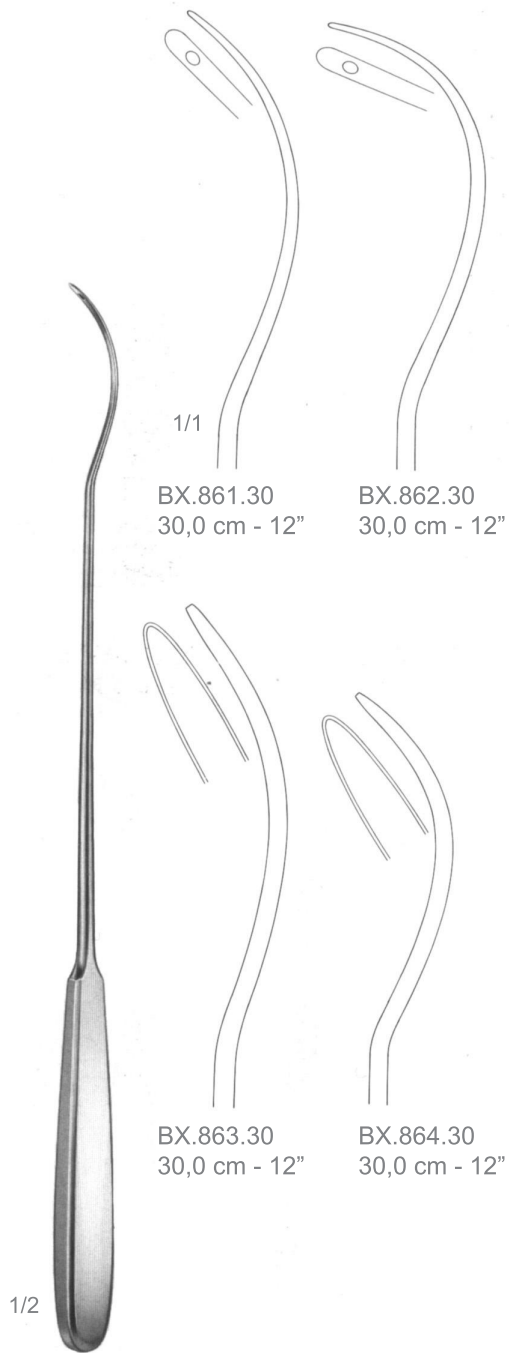

**BX.861.30**  
**BX.862.30**  
**BX.863.30**  
**BX.864.30**  
Brunner  
Ligature Conductors



**BX.865.25**  
Kirschner  
Ligature Conductors



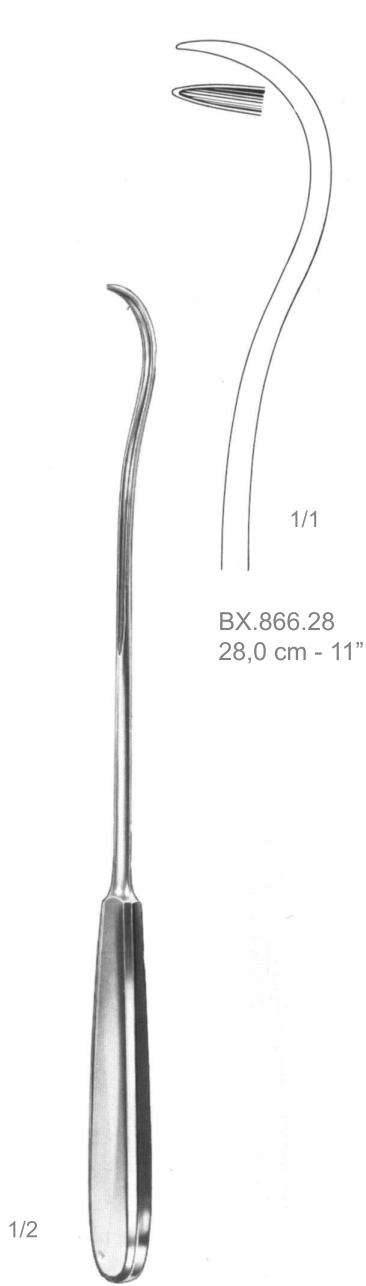

**BX.866.28**  
28,0 cm - 11"

1/2

**BX.866.28**  
Ligature Conductors



**BX.867.25**  
19,0 cm - 7 1/2"

1/2

**BX.867.25**  
Mod. Martin  
Ligature Conductors

**BX**



BX.868.18  
18,0 cm - 7"

BX.868.27  
27,0 cm - 10 1/2"

**BX.868.18/27**  
Brunner-Ferrozell  
Ligature Conductors



BX.869.27  
27,0 cm - 10 1/2"

1/2

**BX.869.27**  
Kirschner-Ferrozell  
Ligature Conductors



BX.870.01  
19,0 cm - 7 1/2"  
Curved

BX.870.02  
19,0 cm - 7 1/2"  
Straight

1/2

**BX.870.01/02**  
Ferrozell  
Ligature Conductors



BX.870.19  
18,5 cm - 7 1/4"

1/2

**BX.870.19**  
Ligature Conductors



BX.870.24  
24,0 cm - 9 1/2"

1/2

**BX.870.24**  
Ferrozell  
Ligature Conductors

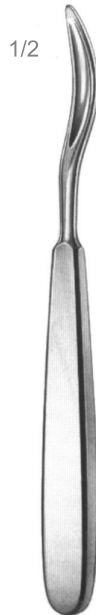

1/2



BX.871.19  
19,0 cm - 7 1/2"

**BX.871.19**  
Schmieden  
Ligature Conductors



1/2

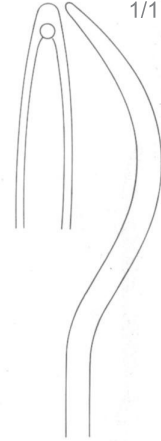

BX.872.19  
19,0 cm - 7 1/2"

**BX.872.19**  
Schmieden-Payr  
Ligature Conductors

1/1

Ligature Conductors, Knot Tiers, Ligature Catcher, Loop Twisters

FÜHRUNGSHOHLSONDEN, FADENKNOTER, -FÄNGER, -SCHLINGENDREHER  
 SONDAS CONDUCTORAS, TUERCE-HILOS, PORTA LIGADURAS

# Kolpen

SUTURE  
 NAHT  
 SUTURA

**BX**



BX.875.03  
 19,5 cm - 7 3/4"

BX.875.05  
 19,5 cm - 7 3/4"

BX.875.07  
 20,0 cm - 8"

**BX.875.03/07**  
 König  
 Ligature Conductors

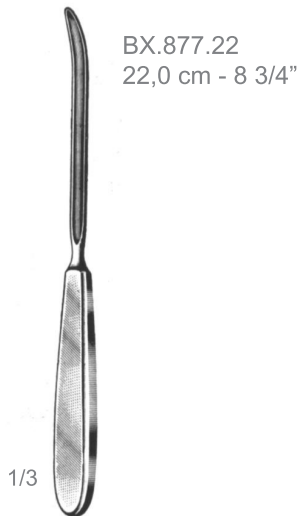

BX.877.22  
 22,0 cm - 8 3/4"



BX.878.22  
 22,0 cm - 8 3/4"

**BX.877.22**  
**BX.878.22**  
 Payr  
 Ligature Conductors

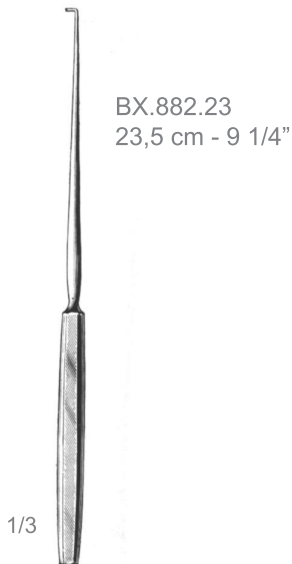

BX.882.23  
 23,5 cm - 9 1/4"

**BX.882.23**  
 Mod. Wien  
 Ligature Conductors



BX.884.21  
 21,0 cm - 8 1/4"

**BX.884.21**  
 Bozemann  
 Ligature Conductors



BX.886.23  
 23,0 cm - 9"

**BX.886.23**  
 Ligature Conductors

**BX**

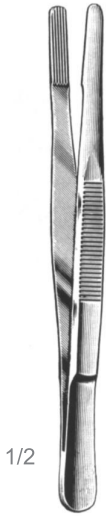

1/2

**BX.894.14**

Ochsner  
Suture Instruments

BX.894.14  
14,0 cm - 5 1/2"



1/2

**BX.901.10**

Lange  
Suture Instruments

BX.901.10  
10,0 cm - 4"



1/2

**BX.904.12**

Wachenfeldt  
Suture Instruments

BX.904.12  
12,0 cm - 4 3/4"

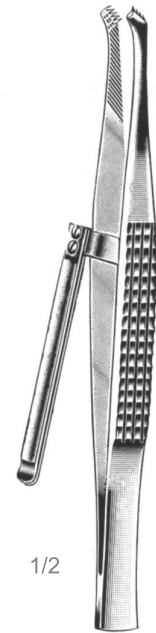

1/2

**BX.910.18**

Childe  
Suture Instruments

BX.910.18  
18,0 cm - 7"



1/2

**BX.916.12**

Michel  
Suture Instruments

BX.916.12  
12,0 cm - 4 3/4"



1/2

**BX.918.12**

Wachenfeldt  
Suture Instruments

BX.918.12  
12,5 cm - 5"



1/2

**BX.922.12**

Hegenbarth  
Suture Instruments

BX.922.12  
12,5 cm - 5"



1/2

**BX.924.12**

Wachenfeldt  
Suture Instruments

BX.924.12  
12,5 cm - 5"



BX.928.12  
12,0 cm - 4 3/4"

1/2

**BX.928.12**  
Michel  
Suture Instruments



BX.929.12  
12,0 cm - 4 3/4"

1/2

**BX.929.12**  
Mod. Michel  
Suture Instruments

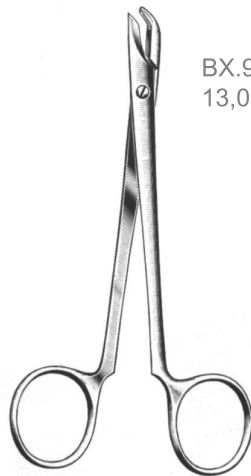

BX.934.12  
13,0 cm - 5"

1/2

**BX.934.13**  
Collin  
Suture Instruments

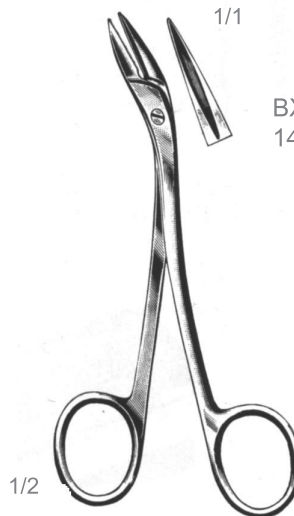

BX.935.14  
14,0 cm - 5 1/2"

1/2

**BX.935.14**  
Richter-Heath  
Suture Instruments

# Kolpen

SUTURE  
NAHT  
SUTURA

## Suture Clips, Suture Set

WUNDKLAMMERN, WUNDNAHTBESTECK - AGRAFES (GRAPAS), ESTUCHES PARA SUTURAS

**BX**

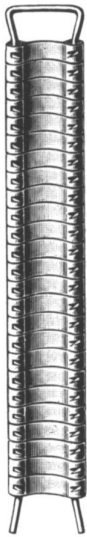

BX.940.01	7,5 x 1,75 mm
BX.940.02	11,0 x 2,00 mm
BX.940.04	12,0 x 3,00 mm
BX.940.05	14,0 x 3,00 mm
BX.940.06	16,0 x 3,00 mm
BX.940.07	18,0 x 3,00 mm
BX.940.08	20,0 x 3,00 mm
BX.940.09	22,0 x 3,00 mm

Unit for Sale: 10 packages =  
1000 ea.

**BX.940.01/09**

Michel  
Suture Clips,  
Suture Set



BX.942.03	12,0 x 3,00 mm
BX.942.04	14,0 x 3,00 mm
BX.942.05	16,0 x 3,00 mm
BX.942.06	18,0 x 3,00 mm
BX.942.07	20,0 x 3,00 mm

Unit for Sale: 1 packages =  
100 ea.

**BX.942.03/07**

Wachenfeldt  
Suture Clips,  
Suture Set

1/2



**BX.952.00**

Mod. Martin  
Suture Clips,  
Suture Set

BX.952.00 130 x 45 x 18 mm

Suture Clip Set in metal case, consisting of  
Suture Clip Forceps Mitchel BX.928.12  
Aproximattion Forceps, Wachenfeldt, with  
Clip Rack BX.904.12  
50 Suture Clips Michel



**BX.959.00**

Mini-Assistent  
Pocket Case

BX.959.00 165 x 90 x 20 mm

Complete in metal case with plastic pouch and interior instrument rack

Contents:

- 1 Mathieu Needle holder, 14 cm (5 1/2")
- 1 Flacon with sterilized silk in alcohol
- 3 Suture needles, assorted
- 1 Needle case, 50 x 25 mm, perforated
- 1 Michel Suture Clip Forceps
- 20 Michel Suture Clips with Clip Holder
- 1 Scalpel handle with blade
- 2 Scalpel blades, interchangeable
- 1 Scissors, straight, blunt/sharp, 13 cm (5")
- 1 Dressing Forceps, fine, 12,5 cm (5")

BX.969.01  
Plastic pouch only

BX.960.00 165 x 90 x 28 mm

Complete in metal case with plastic pouch and removable perforated trays for instruments

Contents:

- 1 Mathieu Needle holder, 14 cm (5 1/2")
- 1 Flacon with sterilized silk in alcohol
- 6 Suture needles, assorted
- 1 Needle case, 64 x 42 mm, perforated
- 1 Michel Suture Clip Forceps
- 20 Michel Suture Clips with Clip Holder
- 1 Scalpel handle with blade
- 3 Scalpel blades, interchangeable
- 1 Scissors, straight, blunt/sharp, 13 cm (5")
- 1 Dressing Forceps, 11,5 cm (4 1/2")
- 1 Tissue Forceps, 12,0 cm (4 3/4"), 1:2 Teeth
- 1 Hunter Splinter Forceps, 10,5 cm (4 1/4")
- 1 Kocher Artery Forceps, straight, 13,0 cm (5")
- 1 Probe with Myrtle leaf, 13,0 cm (5")

BX.962.00  
Ditto, but all instruments with box lock (D)

BX.969.02  
Plastic pouch only



**BX.960.00**

Assistent Standard  
Pocket Case

**BX**

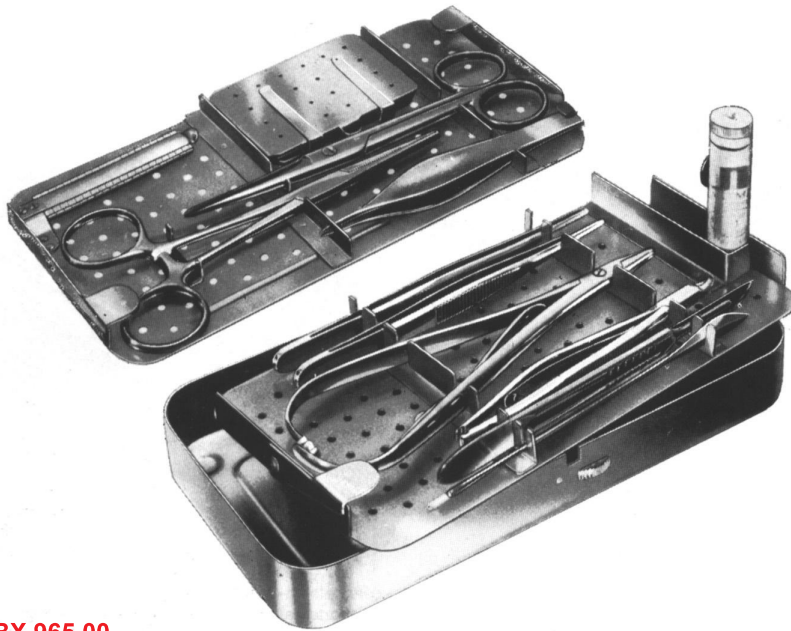

**BX.965.00**

Multi-Assistent  
Pocket Case

BX.965.00 200 x 100 x 27 mm

Complete in metal case with plastic pouch and 2 removable perforated trays for instruments

Contents:

- 1 Mathieu Needle holder, 17 cm (6 3/4")
- 1 Flacon with sterilized silk in alcohol
- 6 Suture needles, assorted
- 1 Needle case, 65 x 42 mm, perforated
- 1 Michel Suture Clip Forceps
- 20 Michel Suture Clips with Clip Holder
- 1 Scalpel handle with blade
- 3 Scalpel blades, interchangeable
- 1 Scissors, straight, blunt/sharp, 14,5 cm (5 1/2")
- 1 Dressing Forceps, 14,5 cm (5 1/2")
- 1 Tissue Forceps, 14,5 cm (5 1/2"), 1:2 Teeth
- 1 Feilchenfeld Splinter Forceps, 11,5 cm (4 1/2")
- 1 Kocher Artery Forceps, 14,0 cm (5 1/2"), D
- 1 Probe with Myrtle leaf, 13,0 cm (5")

BX.969.03

Plastic pouch only





**BX.968.00**  
Venaesectio  
Pocket Case

BX.968.00 200 x 100 x 32 mm

Complete in metal case 200 x 100 x 32 mm, with 2 perforated trays of 18/8 Martinit

Contents:

- 1 Scalpel handle No. 4
- 1 Scalpel blade No. 20, attached to handle No. 4
- 1 Idem, No. 20
- 1 Idem, No. 22, in small, perforated
- 1 Idem, No. 23 container EE.302.65
- 1 Artery and Vessel Scissors, with Knob
- 1 Scissors, curved, pointed/pointed, 10,5 cm
- 1 Semken dressing forceps, serrated, 12 cm
- 1 Idem, 1 x 2 teeth, 12 cm
- 2 Halsted - Mosquito Forceps, curved, 12,5 cm
- 2 Halsted - Mosquito Forceps, straight, 1 x 2 teeth, 12,5 cm
- 3 Backhaus towel clamps, 8 cm
- 1 Finsen retractor, adjustable
- 1 Doyen probe/director, curved
- 1 Mathieu needle holder, 14,0 cm
- 3 Suture needles, assorted, in small container
- 1 Flacon suture silk, in alcohol
- 1 Lange approximation forceps, self-retaining
- 1 Michel suture clips forceps
- 20 Michel suture clips on rack
- 1 Ligature needle, fine
- 1 Perforated small container for needles and scalpel blades, 65 x 42 mm
- 1 Plastic pouch only

**BX**



**BX.975.00**

Martin-Episiotomia  
Pocket Case  
for Perineum Suture

**BX.975.00**

Complete in metal case with plastic pouch and 1 removable perforated instrument tray

Contents:

- 1 Perineum (Episiotomy) Scissors, 14,5 cm (5 1/2")
- 1 Needle Holder MATHIEU, 20 cm (8")
- 1 Operating Scissors, straight, blunt/sharp, 14,5 cm (5 1/2")
- 1 Haemostatic Forceps Kocher, 14,5 cm (5 1/2")
- 1 Dressing Forceps, 16 cm (6 1/4")
- 1 Tissue Forceps, 1:2 Teeth, 16 cm (6 1/4")
- 6 Suture needles, assorted
- 1 Needle Case 65 x 42 mm, perforated
- 1 Flacon Suture Silk in alcohol
- 1 Flacon Catgut in alcohol

**BX.969.03**

Plastic Pouch only