

Kolpen

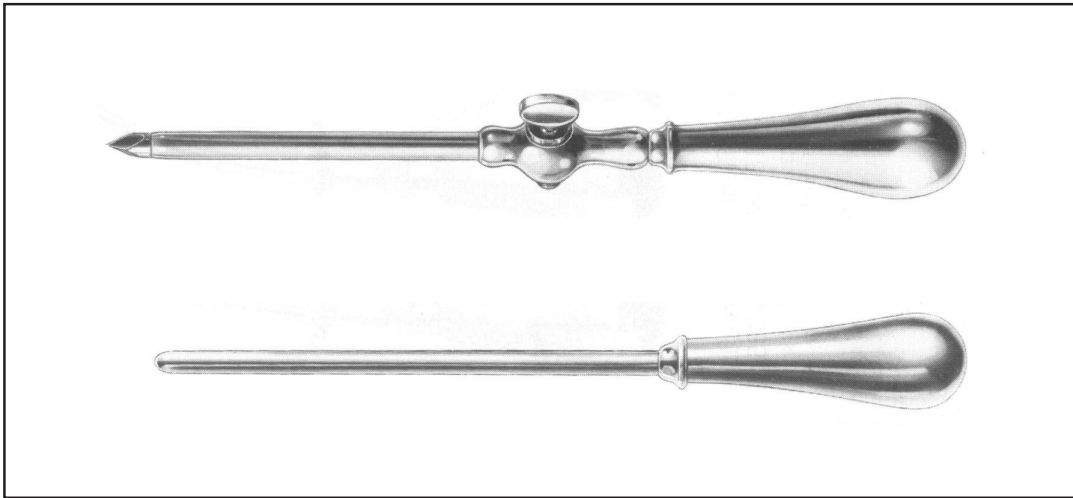

AH

Kolpen

Trocars

VACCINATION AND PUNCTURE TROKARE - TRÓCARES
 IMPFEN UND PUNKTION
 VACUNACIÓN Y PUNCIÓN

AH



1/2

AH.304.03 Set of 3 pieces
 AH.306.04 Set of 4 pieces

AH.304.03
AH.306.04
 Universal
 Trocars



1/2

AH.310.11 11,0 cm - 4 1/2" 3 mm Ø
 AH.312.11 11,0 cm - 4 1/2" 4 mm Ø
 AH.314.11 11,0 cm - 4 1/2" 5 mm Ø
 AH.316.11 11,0 cm - 4 1/2" 6 mm Ø

AH.310.11
AH.312.11
AH.314.11
AH.316.11
 Standard
 Trocars



1/2

AH.320.12 12,0 cm - 4 3/4" 3 mm Ø
 AH.322.12 12,0 cm - 4 3/4" 4 mm Ø
 AH.324.12 12,0 cm - 4 3/4" 5 mm Ø
 AH.326.12 12,0 cm - 4 3/4" 6 mm Ø

AH.320.12
AH.322.12
AH.324.12
AH.326.12
 Standard
 Trocars



1/2

AH.330.12 12,0 cm - 4 3/4" 3 mm Ø
 AH.332.12 12,0 cm - 4 3/4" 4 mm Ø
 AH.334.12 12,0 cm - 4 3/4" 5 mm Ø
 AH.336.12 12,0 cm - 4 3/4" 6 mm Ø

AH.330.12
AH.332.12
AH.334.12
AH.336.12
 Standard
 Trocars

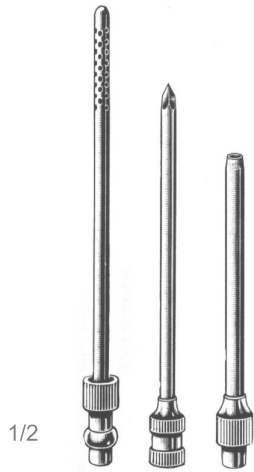

AH.344.11
 11,0 cm - 4 1/2"
 5,5 mm Ø

AH.344.11
 Duke
 Trocars

1/2



1/1

AH.348.07
 21,0 cm - 8 1/2"

AH.348.07
AH.352.11
 Nelson
 Trocars

1/2

AH.350.09
 21,0 cm - 8 1/2"

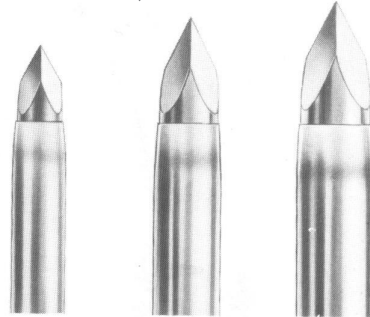

AH.352.11
 21,0 cm - 8 1/2"

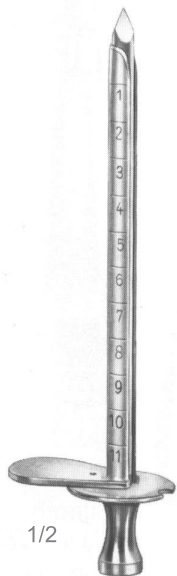

1/1

AH.356.06
 6 mm Ø



AH.356.08
 8 mm Ø

AH.356.06/08
 Campbell
 Trocars

1/2

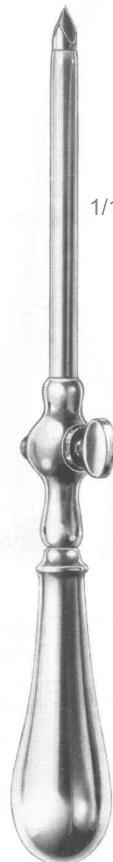

1/1

AH.360.24
 24,0 cm - 9 1/2"
 8 mm Ø

AH.360.24
 Buelau
 Trocars

1/2

Kolpen

Trocars

VACCINATION AND PUNCTURE
IMPFEN UND PUNKTION
VACUNACIÓN Y PUNCIÓN

TROKARE - TRÓCARES

AH



AH.385.23
23,0 cm - 9"
5 mm Ø

AH.389.23
23,0 cm - 9"
5 mm Ø

1/2

1/2

AH.385.23
Fleurant
Trocars

AH.389.23
Fleurant
Trocars

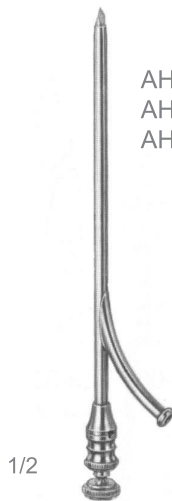

AH.402.14 14,0 cm - 5 1/2" 4 mm Ø
AH.404.14 14,0 cm - 5 1/2" 5,5 mm Ø
AH.406.14 14,0 cm - 5 1/2" 6,5 mm Ø

1/2

AH.402.14
AH.404.14
AH.406.14
Ochsner
Mod. Martin
Trocars



AH.432.20
24,0 cm - 9 1/2"
6 mm Ø

1/2

AH.432.20
Billroth
Trocars

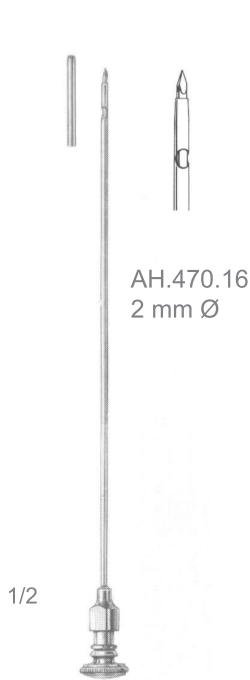

AH.470.16
Landau
Trocars

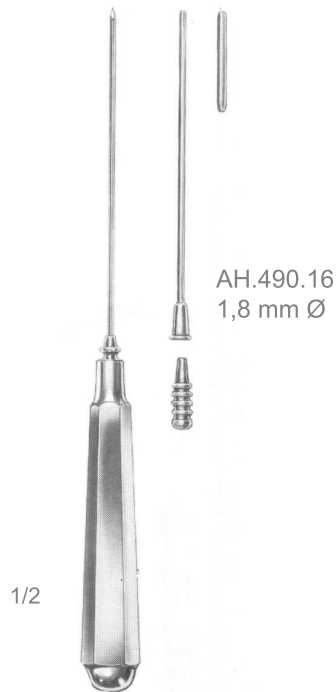

AH.490.19
Lichwitz
Trocars



AH.495.15
Pierce
Trocars



AH.505.15
Krause
Trocars

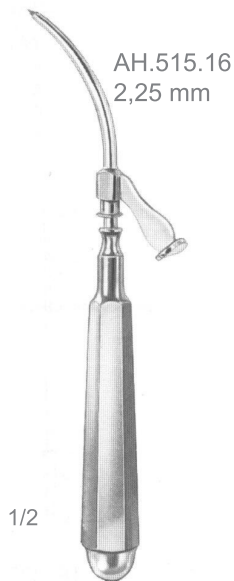

AH.515.16
Coakley
Trocars

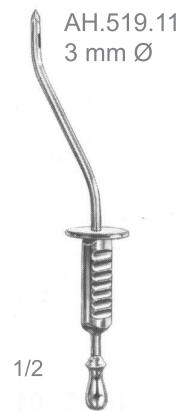

AH.519.11
Douglas
Trocars

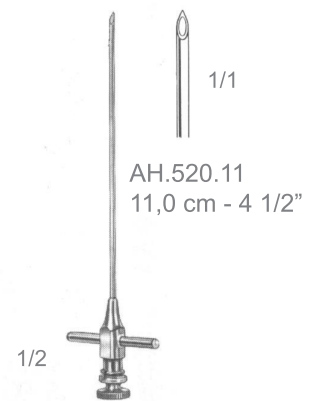

AH.520.11
Trocars

- AH.505.15 Antrum Trocar, with obturator and tubing connection
- AH.515.16 Ditto, with washing tube and fixed tubing connection
- AH.519.11 Trocar Cannula
- AH.520.11 Antrum Puncture Trocar

AH.521.21
 21,0 cm - 8 1/2"
 4 mm Ø



1/2

AH.521.21
 Adson
 Suction Tubes

AH.523.06/12
 19,0 cm - 7 1/2"



1/2

AH.523.06/12
 Frazier
 Suction Tubes

Charr. / Fr.
 6 AH.523.06
 8 AH.523.08
 10 AH.523.10
 12 AH.523.12

AH.523.58/60
 19,0 cm - 7 1/2"

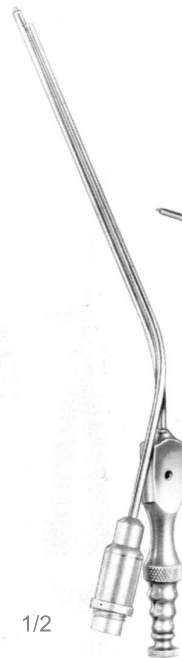

1/2

AH.523.58/60
 Frazier
 Suction Tubes

Charr. / Fr.
 8 AH.523.58
 10 AH.523.60

AH.525.06/12
 13,0 cm - 5"



1/2

AH.525.06/12
 Poppen
 Suction Tubes

Charr. / Fr.
 6 AH.525.06
 8 AH.525.08
 10 AH.525.10
 12 AH.525.12

AH.525.58/60
 13,0 cm - 5"



1/2

AH.525.58/60
 Poppen
 Suction Tubes

Charr. / Fr.
 8 AH.525.58
 10 AH.525.60

AH.523.58 / AH.523.60 With Fiber Optics
 AH.525.58 / AH.525.60 With Fiber Optics



AH.527.00
 Wullstein
 Suction Tubes

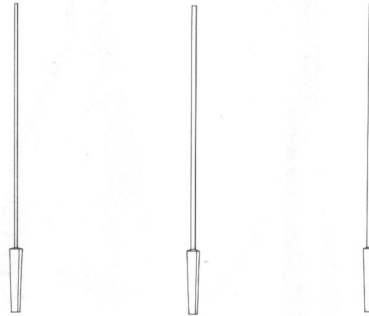

AH.527.04 Suction Tubes
AH.527.06 Suction Tubes
AH.527.08 Suction Tubes

- AH.527.00
- AH.527.01
- AH.527.04
- AH.527.06
- AH.527.08

- Micro suction tube, complete, consisting of:
- Suction tube with Luer hub
 - Micro suction cannula, Ø 0,4 mm
 - Ditto Ø 0,6 mm
 - Ditto Ø 0,8 mm

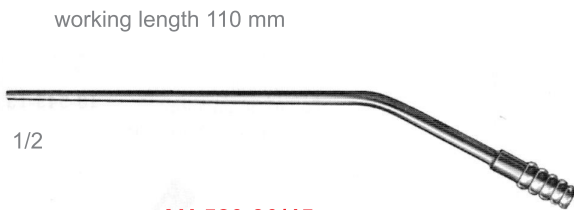

AH.529.30/45
 Luer
 Suction Tubes

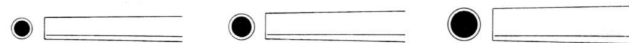

AH.529.30 Conical 3,0 mm Ø
AH.529.35 Conical 3,5 mm Ø
AH.529.45 Conical 4,5 mm Ø

AH

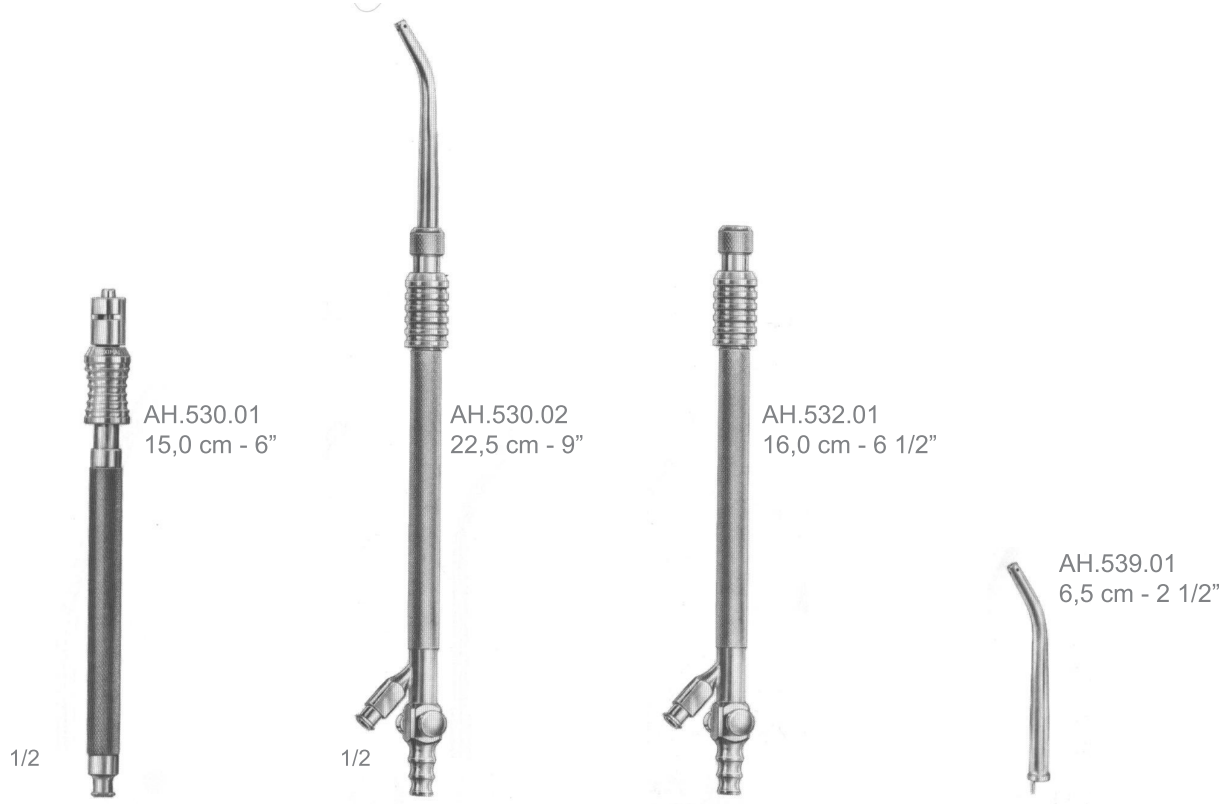

AH.530.01
15,0 cm - 6"
1/2

AH.530.02
22,5 cm - 9"
1/2

AH.532.01
16,0 cm - 6 1/2"

AH.539.01
6,5 cm - 2 1/2"

AH.530.01
Gomel
Suction Tubes

AH.530.02
Hepp/Scheidel
Suction Tubes

AH.532.01
Suction Tubes

AH.539.01
Suction Tubes

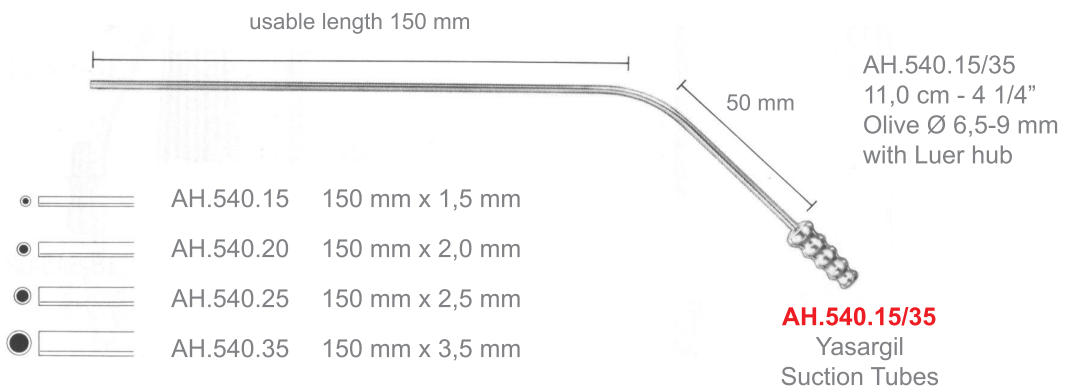

- AH.530.01 Irrigator for Microsurgery
- AH.532.00 Irrigator/Aspirator complete with cannula
- AH.532.01 Irrigator/Aspirator only
- AH.539.01 Suction and Irrigation, Cannula only

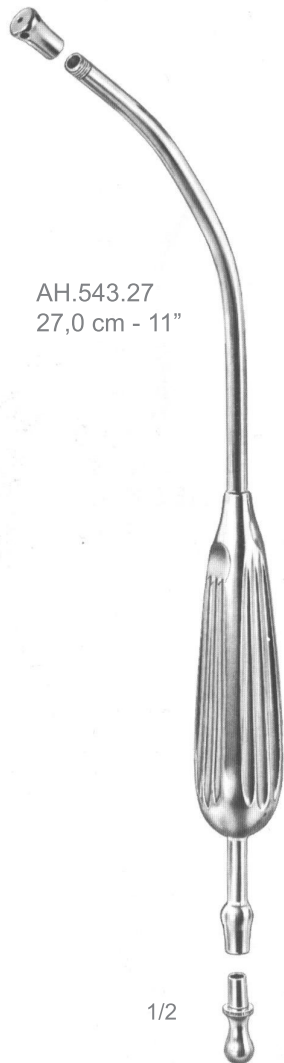

AH.543.27
27,0 cm - 11"

1/2

AH.543.27
Yankauber
Suction Tubes



AH.545.15
Suction Tubes

AH.545.10
Suction Tubes
Fig. 0

AH.545.11
Suction Tubes
1

AH.545.12
Suction Tubes
2

AH.545.13
Suction Tubes
3

AH.545.00/15
27,0 cm - 11"
Fig. 0-3



1/2

AH.545.00/15
Yankauber
Suction Tubes

AH.545.01



AH.545.02

AH

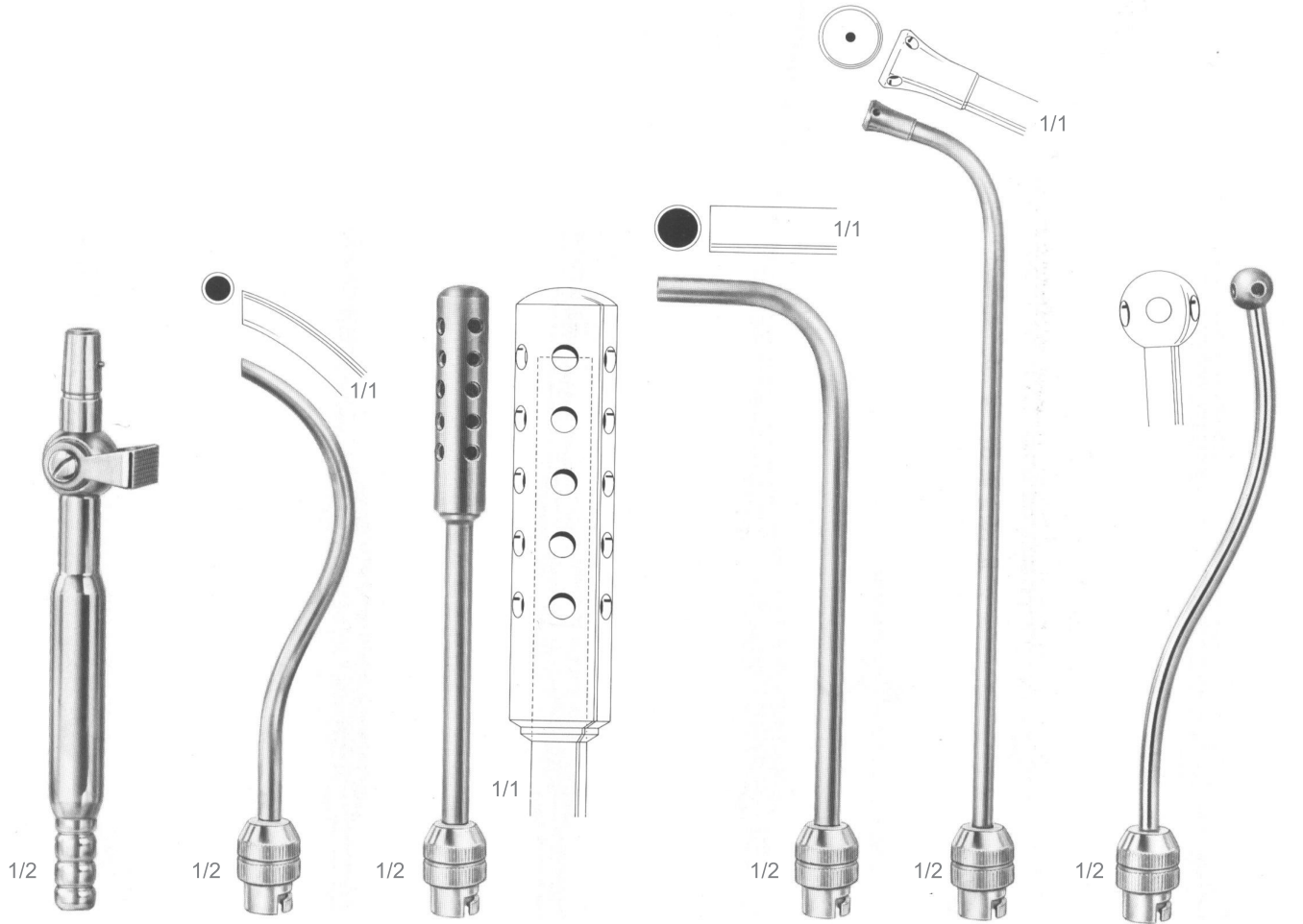

AH.549.01
 Suction Tubes
 AH.549.01
 16,0 cm - 6 1/2"

AH.549.05
 Suction Tubes
 AH.549.05
 16,5 cm - 6 1/2"

AH.549.10
 Suction Tubes
 AH.549.10
 18,5 cm - 7 1/4"

AH.549.15
 Suction Tubes
 AH.549.15
 19,0 cm - 7 1/2"

AH.549.20
 Suction Tubes
 AH.549.20
 19,0 cm - 7 1/2"

AH.549.25
 Suction Tubes
 AH.549.25
 19,0 cm - 7 1/2"
 Ø 7 mm
 Ø 11 mm

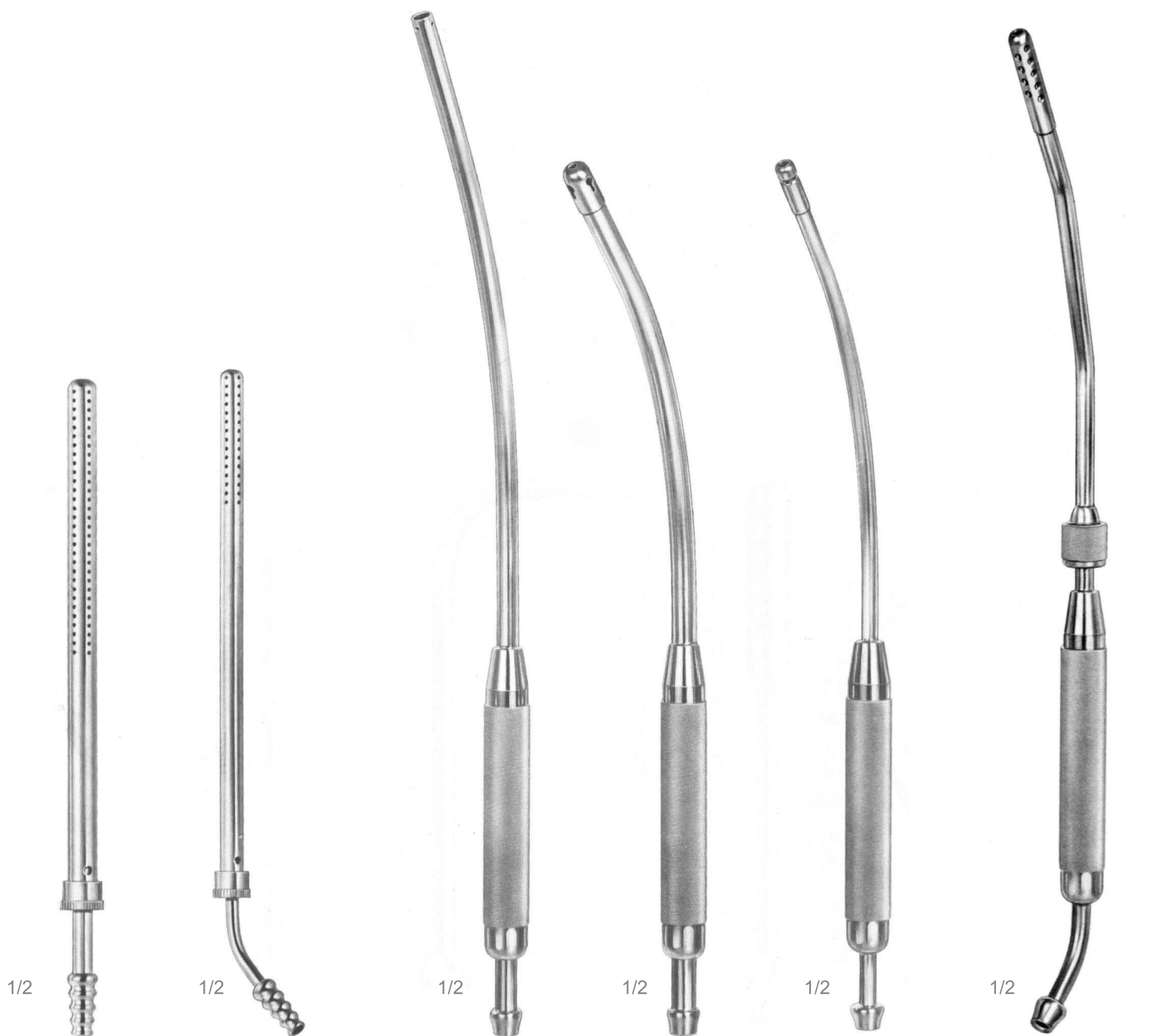

AH.550.22

Poole
 Suction Tubes

AH.550.22
 22,0 cm - 8 3/4"
 10 mm Ø
 (Charr. / Fr. 30)

AH.551.22

Poole
 Suction Tubes

AH.551.22
 22,0 cm - 8 3/4"
 8 mm Ø
 (Charr. / Fr. 23)

AH.561.35

Cooley
 Suction Tubes

AH.561.35
 35,0 cm - 14"

AH.563.31

Cooley
 Suction Tubes

AH.563.31
 31,0 cm - 12 1/2"

AH.565.30

Cooley
 Suction Tubes

AH.565.30
 30,0 cm - 12"

AH.567.33

Cooley
 Suction Tubes

AH.567.33
 33,0 cm - 13 1/4"

Kolpen

Suction Tubes

VACCINATION AND PUNCTURE
 IMPFEN UND PUNKTION
 VACUNACIÓN Y PUNCIÓN

SAUGROHRE - TUBOS DE ASPIRACIÓN

AH

AH.569.21
 21,0 cm - 8 1/2"
 6 mm round

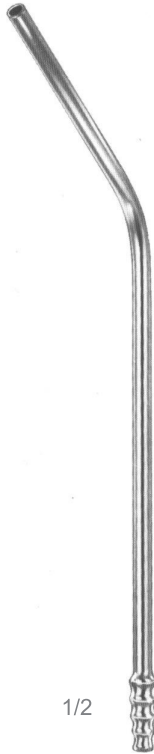

AH.569.21
 Nuboer
 Suction Tubes

AH.571.21
 21,0 cm - 8 1/2"
 6 mm oval



AH.571.21
 Nuboer
 Suction Tubes

AH.575.24
 17,0 cm - 6 3/4"

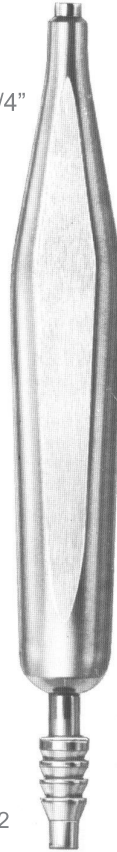

AH.575.24
 Coupland
 Suction Tubes

AH.575.01/04
 Coupland
 Suction Tubes



AH.575.01 1,5 mm Ø
 AH.575.02 2,0 mm Ø
 AH.575.03 2,5 mm Ø
 AH.575.04 3,5 mm Ø

AH.575.05/08
 Coupland
 Suction Tubes



AH.575.05 1,5 mm Ø
 AH.575.06 2,0 mm Ø
 AH.575.07 2,5 mm Ø
 AH.575.08 3,5 mm Ø
 with additional
 side holes

AH.577.01 20,0 cm - 8" 1,5 mm Ø
 AH.577.02 20,0 cm - 8" 2,5 mm Ø
 AH.577.03 20,0 cm - 8" 3,5 mm Ø



AH.577.01/03
 Byrd
 Suction Tubes

AH.579.23
 23,0 cm - 9"
 2,0 mm Ø



AH.579.23
 Cogswell
 Suction Tubes

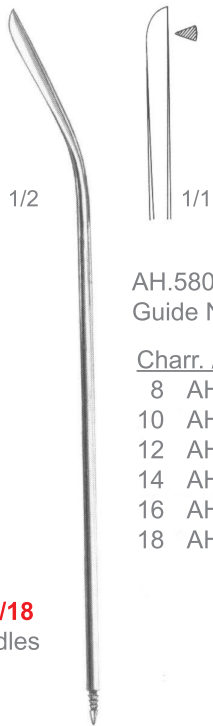

AH.580.08/18
 Guide Needle Straight

Charr. / Fr.	
8	AH.580.08
10	AH.580.10
12	AH.580.12
14	AH.580.14
16	AH.580.16
18	AH.580.18

AH.580.08/18
 Guide Needles



AH.581.08/18
 Guide Needle, curved

Charr. / Fr.	
8	AH.581.08
10	AH.581.10
12	AH.581.12
14	AH.581.14
16	AH.581.16
18	AH.581.18

AH.581.08/18
 Guide Needles

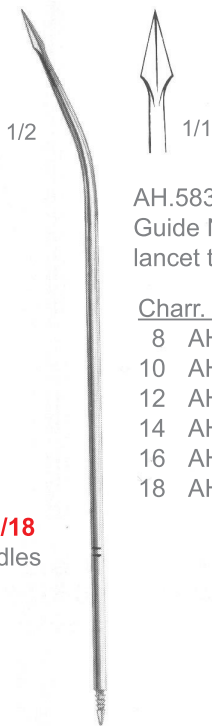

AH.583.08/18
 Guide Needle with
 lancet tip

Charr. / Fr.	
8	AH.583.08
10	AH.583.10
12	AH.583.12
14	AH.583.14
16	AH.583.16
18	AH.583.18

AH.583.08/18
 Guide Needles

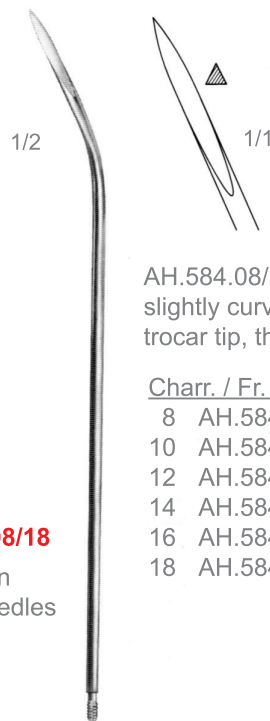

AH.584.08/18
 slightly curved
 trocar tip, threaded end

Charr. / Fr.	
8	AH.584.08
10	AH.584.10
12	AH.584.12
14	AH.584.14
16	AH.584.16
18	AH.584.18

AH.584.08/18
 Redon
 Guide Needles

AH.580.08 - AH.580.18 Redon Guide Needle, straight
 AH.581.08 - AH.581.18 Ditto, curved
 AH.583.08 - AH.583.18 Ditto, with lancet tip
 AH.584.08 - AH.584.18 Ditto, slightly curved trocar tip, threaded end

AH

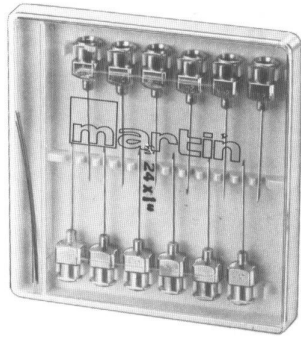

AH.602.01/20
 Luer-Lock
 Hypodermic and
 Special Needles



- | | | |
|---------|-----------|----------------|
| Fig. 1 | AH.602.01 | Ø 0,90 x 38 mm |
| Fig. 2 | AH.602.02 | Ø 0,80 x 32 mm |
| Fig. 12 | AH.602.12 | Ø 0,70 x 32 mm |
| Fig. 14 | AH.602.14 | Ø 0,65 x 28 mm |
| Fig. 16 | AH.602.16 | Ø 0,60 x 25 mm |
| Fig. 18 | AH.602.18 | Ø 0,50 x 23 mm |
| Fig. 20 | AH.602.20 | Ø 0,45 x 20 mm |

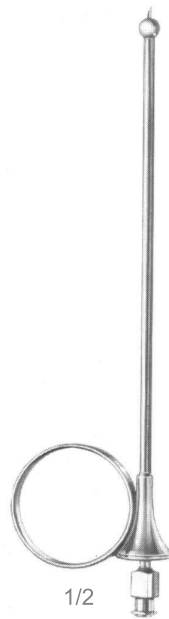

AH.606.00/01
 Hypodermic and
 Special Needles

- | | |
|-----------|--------------|
| AH.610.12 | 1,20 x 80 mm |
| AH.610.15 | 1,50 x 80 mm |



AH.610.12/15
 Hypodermic and
 Special Needles

AH.602.01 - AH.602.20
 AH.606.00

Hypodermic Needle
 Transvaginal anesthesia
 (Pudendus) instrument

AH.606.01
 AH.610.12 - AH.610.15

Needle, 1,00 x 185 mm, only
 Vannula, venous

Hypodermic and Special Needles

INJEKTIONS- UND SPEZIALKANÜLEN - AGUJAS HIPODÉRMICAS Y ESPECIALES

Kolpen

VACCINATION AND PUNCTURE
IMPFFEN UND PUNKTION
VACUNACIÓN Y PUNCIÓN

AH



- AH.630.10 1,20 x 76 mm 18 G x 3"
- AH.630.12 1,20 x 89 mm 18 G x 3 1/2"
- AH.630.14 1,00 x 76 mm 19 G x 3"
- AH.630.16 1,00 x 89 mm 19 G x 3 1/2"
- AH.630.18 0,70 x 76 mm 22 G x 3"
- AH.630.19 0,70 x 50 mm 22 G x 2"
- AH.630.20 0,70 x 89 mm 22 G x 3 1/2"

AH.630.10/20

Quinke
Hypodermic and
Special Needles



- AH.632.12 1,20 x 76 mm 18 G x 3"
- AH.632.14 1,40 x 76 mm 17 G x 3"
- AH.632.16 1,60 x 76 mm 18 G x 3"
with special tip

AH.632.12/16

Tuohy
Hypodermic and
Special Needles



AH.640.15
Tapered tip
0,65 mm Ø
Tonsil Needle
Luer Lock Connection



AH.660.18
1,80 x 35 mm

AH.640.10

Hypodermic and
Special Needles

AH.640.15

Hypodermic and
Special Needles

AH.640.20

Hypodermic and
Special Needles

AH.660.18

Klima-Rossegger
Hypodermic and
Special Needles

AH.665.20
2,00 x 100 mm



AH.666.20
2,0 x 120 mm
Insufflation cannula
Luer Lock Connection



AH.630.10 - AH.632.16
Lumbar Puncture Needles

AH.640.10 - AH.640.20
Tonsil Needles

AH.660.18
Sternum Puncture Needle

AH.665.20
Pneumoperitoneum Needle

AH.665.20

Verres
Hypodermic and
Special Needles

AH.666.20

Verres
Hypodermic and
Special Needles

AH



AH.680.20
2,00 x 220 mm

AH.680.20
Hypodermic and
Special Needles

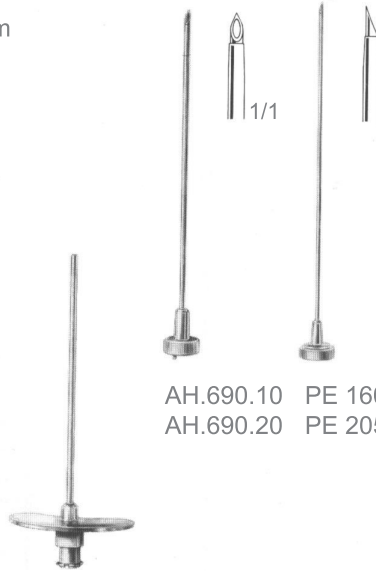

AH.690.10 PE 160 1,60 x 70 mm
AH.690.20 PE 205 2,00 x 70 mm

AH.690.10/20
Seldinger-Style
Hypodermic and
Special Needles



AH.591.15 1,5 mm Ø
AH.591.20 2,0 mm Ø
AH.591.25 2,5 mm Ø
AH.591.30 3,0 mm Ø
AH.591.40 4,0 mm Ø
6,0 cm - 2 1/4"
Luer-Lock connection

AH.691.15/40
Vollmar
Hypodermic and
Special Needles

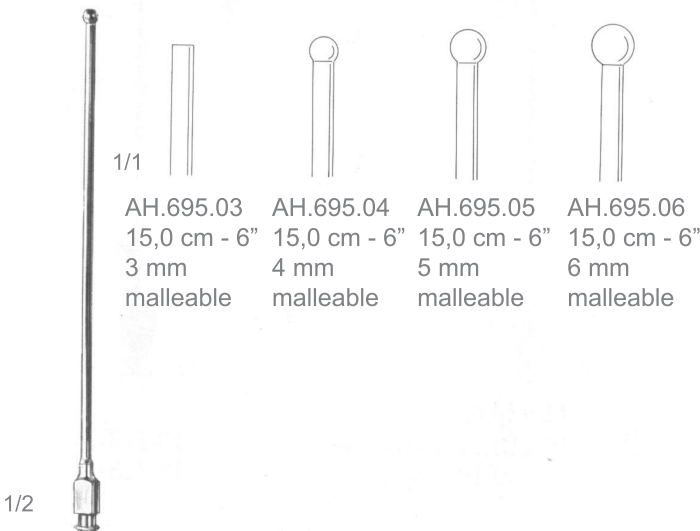

AH.695.03 15,0 cm - 6" 3 mm malleable
AH.695.04 15,0 cm - 6" 4 mm malleable
AH.695.05 15,0 cm - 6" 5 mm malleable
AH.695.06 15,0 cm - 6" 6 mm malleable

AH.695.03/06
Schmid
Hypodermic and
Special Needles



AH.696.06
6,0 cm - 2 1/2"

AH.696.06
Mock
Hypodermic and
Special Needles

AH.680.20 - AH.690.20 Arteriography Needles
AH.695.03 - AH.696.06 Vessel irrigating cannulas, malleable



AH.700.10/50
Menghini
Biopsy Needles

AH.700.10	1,00 x 35 mm
AH.700.15	1,00 x 70 mm
AH.700.20	1,20 x 70 mm
AH.700.25	1,20 x 100 mm
AH.700.30	1,40 x 70 mm
AH.700.35	1,40 x 100 mm
AH.700.40	1,60 x 70 mm
AH.700.50	1,80 x 100 mm



AH.710.14/18
Menghini
Biopsy Needles

AH.710.14	1,40 x 168 mm
AH.710.18	1,80 x 168 mm



AH.715.14/18
Biopsy Needles

AH.700.10 - AH.700.50	Liver Blind Puncture Needles with Stopping Probe
AH.710.14 - AH.710.18	Needles for Controlled Liver Blind Puncture Needles
AH.715.14 - AH.715.18	Trocar for Introduction of Liver Blind Puncture Needles

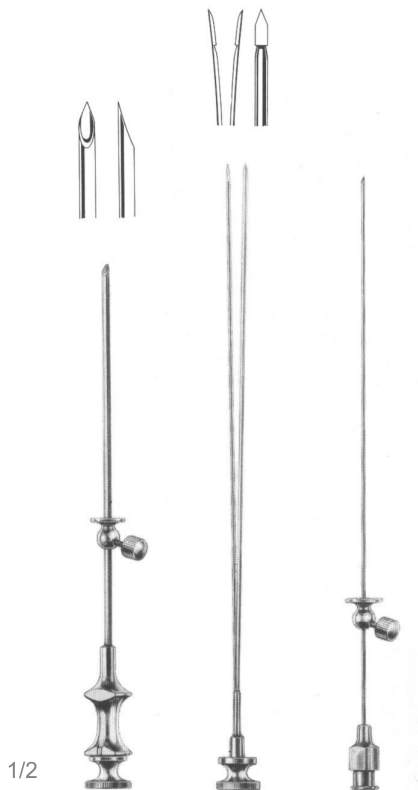

AH.730.20/40

Franklin-Silverman
mod. Fuchs
Biopsy Needles

AH.730.20 outer Ø 2,00 x 105 = 14 G x 4"
inner Ø 1,50 x 155 mm = 17 G x 6"
including needle
Ø 1,00 x 150 mm = 19 G x 6"

AH.730.24 outer Ø 2,00 x 130 = 14 G x 5"
inner Ø 1,50 x 180 mm = 17 G x 7"
including needle
Ø 1,00 x 150 mm = 19 G x 6"

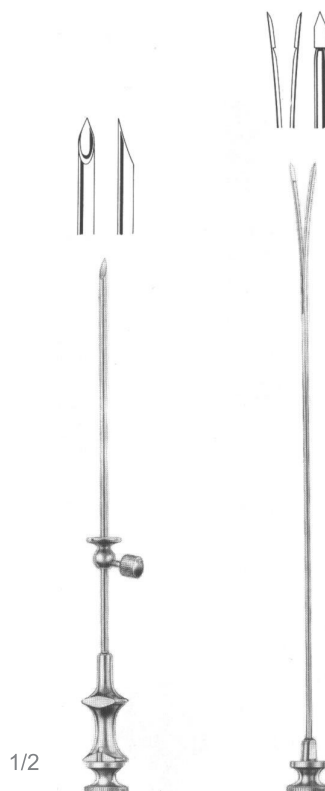

AH.750.20

AH.756.25

Franklin-Silverman
Biopsy Needles

Cat. Ref.	Biopsy Needle (Cannula)	Split Biopsy Needle
AH.750.20	2.00 x 100 mm	1.50 x 150 mm
AH.750.30	2.50 x 145 mm	2.00 x 195 mm
AH.755.20	2.00 x 100 mm	1.50 x 150 mm
AH.755.25	2.50 x 145 mm	2.00 x 195 mm

Cat. Ref. Split Biopsy Needle, only

AH.752.20	1.50 x 150 mm
AH.752.30	2.00 x 195 mm
AH.756.20	1.50 x 150 mm
AH.756.25	2.00 x 195 mm

AH.730.20 - AH.730.40
AH.750.20 - AH.752.30

Kidney Puncture Needles

Franklin-Silverman Kidney Biopsy Needle,
consisting of split needle with full tips, without barb,
and biopsy needle (cannula), with adjustable depth stopmark

AH.755.20 - AH.756.25

Ditto, barbed



1/2

AH.800.00 AH.802.00 AH.804.00 AH.806.00

Connecting Pieces and Stopcocks



**AH.820.16
AH.820.35**

AH.825.01 2,5 x 4,0 mm
AH.825.02 2,5 x 6,5 mm
AH.825.03 2,5 x 9,0 mm



AH.825.01/03
Connecting Pieces
and Stopcocks

AH.820.16 for Tubings PE 160
AH.820.20 for Tubings PE 205
AH.820.25 for red Oedmann-Ledin Catheters
AH.820.30 for green Oedmann-Ledin Catheters
AH.820.35 for yellow and grey
Oedmann-Ledin Catheters



1/2

AH.830.00 AH.840.00 AH.845.00

Connecting Pieces and Stopcocks



AH.850.03/13

Cat. Ref.	Ø	for Catheters Charr./Fr.
AH.850.03	3 mm	14
AH.850.04	4 mm	16
AH.850.05	5 mm	18
AH.850.06	6 mm	20/22
AH.850.07	7 mm	24/26
AH.850.08	8 mm	28/30
AH.850.09	9 mm	32/34
AH.850.10	10 mm	36
AH.850.11	11 mm	38
AH.850.12	12 mm	40/42
AH.850.13	13 mm	44/46

- AH.800.00 Connecting Piece LLA female - RC male
- AH.802.00 Metal Connecting Piece RC female - LA male
- AH.804.00 Connecting Olive LLA male for 6 mm tubings
- AH.806.00 Connecting Olive LLA female for 3/16" tubings
- AH.820.16 - AH.820.35 Stopcock for Catheters LLA female
- AH.825.01 - AH.825.03 Catheter Fitting
- AH.830.00 Urethral Olive, LL female
- AH.840.00 Stopcock LL female/LL male
- AH.845.00 Three-Way-Stopcock, 1 x LL male, 1 x LL female
- AH.800.00 Connecting Piece LLA female - RC male
- AH.850.03 - AH.850.13 Connector for Trachea Tubes

Kolpen

Hypodermic Syringes

VACCINATION AND PUNCTURE SPRITZEN - JERINGAS
 IMPFEN UND PUNKTION
 VACUNACIÓN Y PUNCIÓN

AH

- AH.900.01 1 ml
- AH.900.02 2 ml
- AH.900.05 5 ml
- AH.900.10 10 ml
- AH.900.20 20 ml
- AH.900.50 50 ml

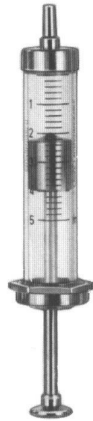

AH.900.01/50
 Luer
 Hypodermic
 Syringes

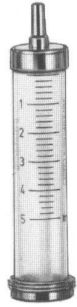

AH.902.01/50
 Luer
 Hypodermic
 Syringes

- AH.902.01 1 ml
- AH.902.02 2 ml
- AH.902.05 5 ml
- AH.902.10 10 ml
- AH.902.20 20 ml
- AH.902.50 50 ml

- AH.910.01 1 ml
- AH.910.02 2 ml
- AH.910.05 5 ml
- AH.910.10 10 ml
- AH.910.20 20 ml
- AH.910.50 50 ml

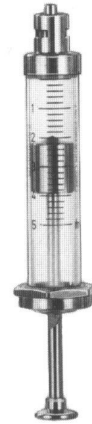

AH.910.01/50
 Luer-Lock
 Hypodermic
 Syringes

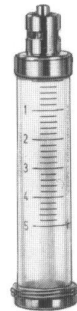

AH.912.01/50
 Luer-Lock
 Hypodermic
 Syringes

- AH.912.01 1 ml
- AH.912.02 2 ml
- AH.912.05 5 ml
- AH.912.10 10 ml
- AH.912.20 20 ml
- AH.912.50 50 ml

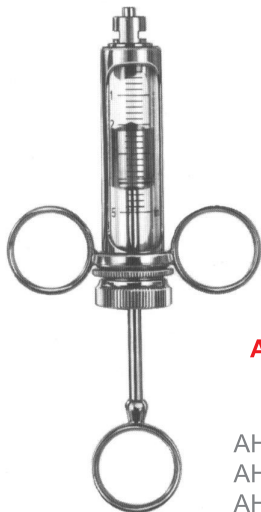

AH.915.02/10
 Hypodermic
 Syringes

- AH.915.02 2 ml
- AH.915.05 5 ml
- AH.915.10 10 ml



AH.917.02/10
 Hypodermic
 Syringes

- AH.917.02 2 ml
- AH.917.05 5 ml
- AH.917.10 10 ml

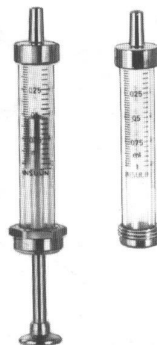

AH.920.01/02
 Insulin-Luer
 Hypodermic
 Syringes

- AH.920.01 1 ml (40)
- AH.920.02 2 ml (80)

AH.922.01/02
 Insulin-Luer
 Hypodermic
 Syringes

- AH.922.01 1 ml
- AH.922.02 2 ml

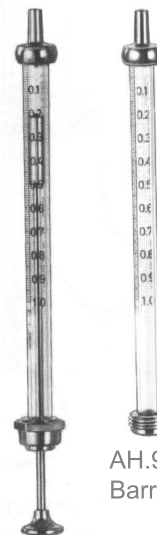

AH.925.01
 Tuberkulin-Luer
 Hypodermic
 Syringes
 AH.925.01 1 ml (100)

AH.926.01
 Tuberkulin-Luer
 Hypodermic
 Syringes

- AH.926.01 1 ml



AH.930.05/20

Janet Wound- and
Bladdersyringes
Hypodermic
Syringes

AH.930.05 50 ml
AH.930.10 100 ml
AH.930.15 150 ml
AH.930.20 200 ml



AH.932.05/20

Hypodermic
Syringes

AH.932.05 50 ml
AH.932.10 100 ml
AH.932.15 150 ml
AH.932.20 200 ml
Barrels